

The Washington County Department of Education met in regular session on February 27, 2024 at 5:00 PM in the Central Office. Attendance is as follows: **Present:** Annette Buchanan, Mary Beth Dellinger, Keith Ervin, Chad Fleenor, David Hammond, Gregg Huddleston, Mike Masters, Whitney Riddle, Vince Walters..

REQ DATE
01/29/2024

Washington County Schools Nutrition

405 West College Street
 Jonesborough, TN 37659
 423-753-1107
 nutrition@wcde.org

REQUISITION NUMBER
1430000188

VENDOR KEY : NETCO 000
 SHIP DATE : 01/29/2024
 FISCAL YEAR : 2023-2024
 ENTERED BY : DEMELCON000

PRINTED 02/06/2024

VENDOR:
 NETCO
 100 E MAPLE ST
 JOHNSON CITY, TN 37601

SHIP TO:
 Washington County Schools - Food Service
 405 W COLLEGE ST
 JONESBOROUGH, TN 37659

ATTN: CONSTANCE DEMELO

QUANTITY	UNIT	DESCRIPTION OF ITEMS OR MATERIALS	UNIT PRICE	AMOUNT
1		NETCO PROCESSING FEE	44927.02000	44,927.02
ACCOUNT SUMMARY (FOR INTERNAL USE)				
		ACCOUNT NUMBER	ACCOUNT AMOUNT	
		143 E 73100 399 000 00010 000	5,615.88	
		143 E 73100 399 000 00011 000	2,246.35	
		143 E 73100 399 000 00012 000	898.54	
		143 E 73100 399 000 00020 000	3,594.16	
		143 E 73100 399 000 00021 000	3,144.89	
		143 E 73100 399 000 00022 000	3,144.89	
		143 E 73100 399 000 00023 000	2,246.35	
		143 E 73100 399 000 00030 000	5,615.88	
		143 E 73100 399 000 00031 000	2,246.35	
		143 E 73100 399 000 00032 000	2,695.62	
		143 E 73100 399 000 00033 000	5,391.24	
		143 E 73100 399 000 00040 000	4,043.43	
		143 E 73100 399 000 00041 000	4,043.44	
			PAGE TOTAL	44,927.02
			TOTAL	44,927.02

This is a Requisition and not an official Purchase Order.
 The District is not financially responsible for the
 unauthorized purchases made with a Requisition.

11/28/2023

Extra pounds-Gold Creek Chicken

March Delivery	Popcorn Chicken	Processing Cost	Drum & Thigh	Processing Cost
District	496	\$50.88 per case	59	\$64.64 per case
Bristol	16	\$814.08		\$0.00
Carter	16	\$814.08		\$0.00
Cocke	16	\$814.08		\$0.00
Grainger	34	\$1,729.92	10	\$646.40
Greeneville	34	\$1,729.92		\$0.00
Hamblen	66	\$3,358.08		\$0.00
Hawkins	66	\$3,358.08	16	\$1,034.24
Jefferson	34	\$1,729.92	17	\$1,098.88
Johnson City	50	\$2,544.00	16	\$1,034.24
Johnson Co.	16	\$814.08		\$0.00
Newport	0	\$0.00		\$0.00
Rogersville	0	\$0.00		\$0.00
Sullivan	66	\$3,358.08		\$0.00
Unicoi	16	\$814.08		\$0.00
Washington	66	\$3,358.08	0	\$0.00
TOTALS	496	\$25,236.48	59	\$3,813.76

Yang's Breaded Chicken (38.05 DF) 516 cases		19633.8	What we can receive	Orange	General Tso's	Sweet & Sour		\$150.69
NETCO District	% of original order	POUNDS	CASES	\$ 150.69	\$ 150.69	\$ 150.69	Total Cases	@ \$150.69 per case
Bristol	4.81%	943.81	25	0	50	0	50	\$ 7,534.50
Carter Co.	7.00%	1,374.18	36	0	0	0	0	\$ -
Cocke Co.	6.93%	1,359.82	36	0	0		0	\$ -
Grainger Co.	4.10%	805.03	21	0	25	25	50	\$ 7,534.50
Greeneville	4.29%	841.74	22	30	0	10	40	\$ 6,027.60
Hamblen Co.	14.95%	2,934.38	77	0	0	0	0	\$ -
Hawkins Co.	9.01%	1,769.60	47	0	0	0	0	\$ -
Jefferson Co	10.00%	1,964.28	52	0	0	50	50	\$ 7,534.50
Johnson City	9.34%	1,834.16	48	38	38	0	76	\$ 11,452.44
Johnson Co.	2.72%	534.46	14	0	0	0	0	\$ -
Newport	0.94%	184.16	5	0	0	0	0	\$ -
Rogersville	0.85%	166.59	4	0	0	0	0	\$ -
Sullivan Co.	12.36%	2,426.64	64	0	0	0	0	\$ -
Unicoi Co.	2.96%	581.68	15	0	0	0	0	\$ -
Washington Co.	9.74%	1,913.30	50	254	0	0	254	\$ 38,275.26
TOTAL	100.00%	19,633.80	516	322	113	85	520	\$ 78,358.80

520

Formula in column E times the DF (drawdown per case)

JTM CHEESE SAUCES (15.00 DF) 382 cases		5734.77	What we can receive	Queso \$51.50	Cheddar \$50.48	3 Cheese \$51.36	District Totals
NETCO District	% of original order	POUNDS	CASES				
Bristol	4.81%	275.67	18	18			\$ 927.00
Carter Co.	7.00%	401.38	27		27		\$ 1,362.96
Cocke Co.	6.93%	397.18	26	26			\$ 1,339.00
Grainger Co.	4.10%	235.14	16		16		\$ 807.68
Greeneville	4.29%	245.86	16	8	8		\$ 815.84
Hamblen Co.	14.95%	857.09	57	38		19	\$ 2,932.84
Hawkins Co.	9.01%	516.88	34	34			\$ 1,751.00
Jefferson Co	10.00%	573.74	38	5	17	16	\$ 1,937.42
Johnson City	9.34%	535.73	36	16	20		\$ 1,833.60
Johnson Co.	2.72%	156.11	10	0	0	0	\$ -
Newport	0.94%	53.79	4	4			\$ 206.00
Rogersville	0.85%	48.66	3	0	0	0	\$ -
Sullivan Co.	12.36%	708.79	47			47	\$ 2,413.92
Unicoi Co.	2.96%	169.90	11	5	6		\$ 560.38
Washington Co.	9.74%	558.85	37		52		\$ 2,624.96
TOTAL	100.00%	5,734.77	382	154	146	82	\$ 19,512.60
			382	\$7,931.00	\$ 7,370.08	\$4,211.52	\$ 19,512.60

Johnson Co and Rogersville cheese to Washington CO
 2 Extra from formula to Washington Co
 *Caitlin was the only district that asked me for more if there was any extra

Pork Rib		1825.7	Cost per case
NETCO District	% of original order	24.75 CASES	\$ 83.59
Bristol	4.81%	87.764	4 \$ 334.36
Carter Co.	7.00%	127.78	5 \$ 417.95
Cocke Co.	6.93%	126.45	5 \$ 417.95
Grainger Co.	4.10%	74.859	6 \$ 501.54
Greeneville	4.29%	78.273	0
Hamblen Co.	14.95%	272.87	12 \$ 1,003.08
Hawkins Co.	9.01%	164.55	9 \$ 752.31
Jefferson Co	10.00%	182.66	7 \$ 585.13
Johnson City	9.34%	170.56	8 \$ 668.72
Johnson Co.	2.72%	49.699	0
Newport	0.94%	17.124	0
Rogersville	0.85%	15.491	0
Sullivan Co.	12.36%	225.65	9 \$ 752.31
Unicoi Co.	2.96%	54.09	0
Washington Co.	9.74%	177.92	8 \$ 668.72
TOTAL	100.00%	1825.7	73 \$ 6,102.07

March order

PURCHASING DEPARTMENT
WASHINGTON COUNTY BOARD OF EDUCATION

Purchase Order **Nº 1615**

Date Issued 2/6/24

Appropriation No. 141-E-71300-471-002

Dept. ISM middle

School University High School

PURCHASE ORDER

TO Transfr Inc.
 2196 Third Ave., PMB 20026
 New York, NY 10035
ATTN: Accounts Receivable

Deliver to University High school
 Address 68 Martha Culp Ave.
 Johnson city, TN 37614
 Via Destiny McRee

Articles on this order must be charged to account of

NOTICE TO VENDOR

1. Purchase order **MUST** bear two signatures in order to be valid.
2. Purchase order number **MUST** appear on all invoices submitted for payment.
3. Mail **TWO** copies of your invoice promptly to:

Washington County Board of Education
 405 West College Street
 Jonesborough, TN 37659
 Telephone (423) 753-1105

ARTICLES OR SERVICES	CODE	QUANTITY & UNIT	UNIT PRICE	TOTAL
(Unless otherwise stated all prices F.O.B. Destination)				
Career Exploration		6	\$0 -	\$0 -
Career Exploration 2.0		6	\$2,000 -	\$12,000 -
*SOLE source attached				
GRAND TOTAL - INCLUDING ALL ATTACHED PAGES				\$12,000 -

SUBJECT TO THE FOLLOWING CONDITIONS

1. All packages, cartons or other containers must be plainly marked with the purchase order number.
2. The right is reserved to purchase in the open market and to charge the difference to the Vendor in the event that deliveries are not made at the time specified in the bid and on this order.
3. Whenever a delivery is rejected, the Vendor shall be notified and be given the reason for the rejection. All rejected deliveries shall be held at the Vendor's risk and he shall bear the expense of removal.
4. Acceptance of this order includes acceptance of all terms, prices, delivery, instructions, specifications and conditions stated.
5. The county is not liable for Federal excise tax or state sales tax.
6. Each shipment and/or each purchase order should be covered by separate invoice.

IMPORTANT: INVOICES AND PACKAGES MUST BEAR PURCHASE ORDER NUMBER

VENDOR'S COPY

There is an otherwise unincumbered balance to the credit of the proper appropriation, allotment or fund to meet the expenditure covered by this purchase.

Authorized Signature

APPROVED:

Purchasing Agent

KH



TRANSFR INC.
 2196 Third Ave., PMB 20026
 New York, NY 10035
 Attn: Accounts Receivable
 accountsreceivable@transfrvr.com
 646-466-2600

SERVICE ORDER

Quote #: Q-11479-7
Quote Expires On: 2/29/2024
Effective Start Date: 3/4/2024

Customer: Washington County School - TN
Primary Contact:
 Kelli Hauldren
 68 Martha Culp Ave
 Johnson City, TN 37614
 US
Phone: 423-753-1100
Email: hauldrenk@wcde.org

Dashboard Administrator
Contact: Destiny McRee
Email: mcreed@etsu.edu

Bill To:
 Washington County School - TN
 405 W College Street
 Jonesborough, TN 37659
 US
Billing Email: hauldrenk@wcde.org

Ship To:
 University School - East Tennessee State University
 68 Martha Culp Ave
 Johnson City, TN 37614
 US
Shipping Contact: Destiny McRee
Shipping Email: mcreed@etsu.edu

Please review or complete the following information:

State Sales Tax Exempt (SSTE)?* Yes

**Purchase Order (PO) required by
 Bill To organization to finalize purchase?***** Yes

SSTE Number if applicable:

P.O. Number if applicable:

*If applicable, Transfr must receive your State Sales Tax Exemption Certification prior to generating an invoice.

NOTE: State Sales Tax Exemption does not include federal or IRS Non-Profit status, 501c3, etc.

**If applicable, Transfr must receive required Purchase Orders prior to generating an invoice

NOTE: Required Purchase Orders (POs) often have additional terms that must be agreed to prior to finalizing the contract, and contain instructions on how the Bill To organization is to be invoiced.

TRANSFR INC. 2196 Third Ave., PMB 20026 New York, NY 10035
 646-466-2600

Quote #:
 Q-11479-7
 Page 1 of 3

Total Headsets Provided by Transfr: 6
Total Headsets Already With Customer:
Additional Headsets Provided With This Order: 6

Service Offering	Start Date	End Date	Quantity	Cost Per License	Net Total
Career Exploration	3/4/2024	3/3/2025	6	\$0.00	\$0.00
Career Exploration 2.0	3/4/2024	3/3/2025	6	\$2,000.00	\$12,000.00

SUB TOTAL: \$12,000.00
 ESTIMATED TAXES TOTAL: \$0.00
TOTAL: \$12,000.00

- Career Exploration simulations will NOT be incorporated into the Transfr dashboard. Only the Career Exploration 2.0 simulations will be incorporated into the Transfr dashboard.
- Access to legacy Career Exploration will require opt-in via a short survey. Customer will receive the survey, following submission of the signed Service Order.
- Implementation Training and Technical Support services are included for the term of the contract.
- Billing Terms:
 - Billing Frequency: Full Amount
 - Payment due Net 30 from invoice date.
 - NOTE: To avoid any delays/issues with spam filters, please add accountsreceivable@transfrvr.com to your list of authorized email addresses. All invoices will be sent from that email to the billing contact listed on this Service Order.
- Total price does not include taxes
- Transfr, Inc. will cover the cost of shipping to and from the designated client location. The Customer shall be responsible for the proper receiving, safe storage, and any additional transfer of the Equipment for the duration of the contract.
- **Headsets require WiFi Internet Access - standard training sessions use ~50mb total.**

Transfr's Terms of Use ("Terms of Use") are hereby incorporated by reference and made a part hereof. By signing this Service Order, Customer and Transfr agree to the terms set forth in the Terms of Use.

The Terms of Use can be found at:

<https://transfrinc.com/terms>.

In the event that Customer and Transfr have executed a separate master services agreement ("MSA"), the provisions of the MSA shall prevail in the event of any conflict between the provisions of the MSA, the Terms of Use, and/or this Service Order.

Capitalized terms utilized but not defined in this Service Order are defined in the Terms of Use. This Service Order constitutes an agreement by Customer to purchase certain products and services from Transfr in accordance with the terms and conditions set forth herein and in the Terms of Use or MSA and does not constitute an invitation to negotiate. This Service Order is governed by the Terms of Use.

IN WITNESS WHEREOF, Transfr and Customer have executed this Service Order.

**Washington
County
Schools - TN**

**TRANSFR
INC.**

Signature: Kelli Hauldren
Name: Kelli Hauldren
Title: CTE SUPERVISOR
Dated: 2/6/24

Signature: _____
Name: _____
Title: _____
Dated: _____

THANK YOU FOR YOUR BUSINESS!



Re: Sole Source Information Updated May 2023

To Whom It May Concern,

Transfr is pleased to provide this letter to assist your market research efforts and to help support any determination that a sole source award is appropriate. **Transfr is the sole provider of the proprietary Transfr Virtual Training Facility and Career Exploration Facility for the set of hands-on, simulation-based training skills that you requested from Transfr's catalog.**

Transfr's simulation-based training teaches novice students in the same manner that experts master their crafts - through trial and error. Trainees receive one-on-one guidance from a digital coach in a job-training simulation that provides engaging, hands-on training to acquire the skills needed to obtain a job, in a way that traditional learning such as lectures, books or videos typically cannot.

- To our knowledge, Transfr is the only vendor that offers a hands-on intelligent tutoring system that provides a) simulation-based training in a Virtual Training Facility b) a proprietary digital coach that helps students improve their performance and master each skill c) specialized algorithms to evaluate the performance of each student on the skills requested, and d) dashboards that provide instructors with the details of a learner's performance.
- Transfr simulations include a proprietary automated digital coach that tutors students in a master-apprentice environment with step-by-step instruction and unlimited hands-on practice of skills.
- Transfr's tutoring system is capable of quantifying each learner's behaviors within the training simulation, while guiding them to mastery at their own pace. Transfr's scoring system is driven by machine learning and psychometric algorithms that capture learning behaviors and trends such as efficiency, misconceptions, and error corrections. The algorithms are transferable across tasks and simulation environments, and provide one of the first comprehensive data-driven examinations of mastery and competency within a simulation-based environment. Instructor dashboards provide immediate access to learner data with matrices developed by Transfr showing detailed performance and response time, along with the skills a learner has mastered:

Transfr, Inc.
2196 Third Ave
PMB 20026
New York, NY 10035

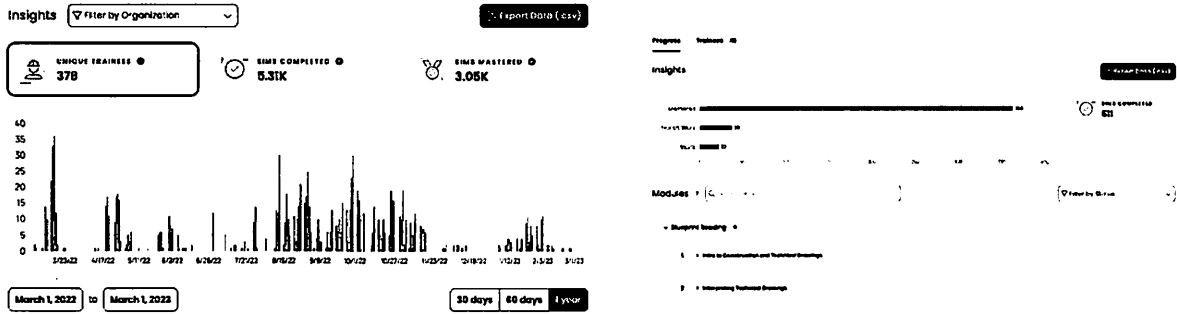

- To use Transfr’s training environment software, Virtual Reality hardware is required which Transfr provides with each license. Transfr manages all hardware and software support and maintenance, included under each license.

We are honored that you would like to partner with Transfr. We look forward to working with you and your community to build an ecosystem that involves education, local government and business & industry to provide classroom to career pathways and upward mobility.

Thank you,

Sincerely,

Bharanidharan Rajakumar

CEO, Transfr Inc

Transfr, Inc.
2196 Third Ave
PMB 20026
New York, NY 10035

**PURCHASING DEPARTMENT
WASHINGTON COUNTY BOARD OF EDUCATION**

Purchase Order **No 1907**

Date Issued **2/20/24**

Appropriation No. **72250499**

Dept. **Technology**

School **System-wide**

PURCHASE ORDER

TO **Gov. Conn.**

Deliver to **WCDE - C. Fullbright**

Address

Via

Articles on this order must be charged to account of

NOTICE TO VENDOR

1. Purchase order **MUST** bear two signatures in order to be valid.
2. Purchase order number **MUST** appear on all invoices submitted for payment.
3. Mail **TWO** copies of your invoice promptly to:

**Washington County Board of Education
405 West College Street
Jonesborough, TN 37659
Telephone (423) 753-1105**

ARTICLES OR SERVICES (Unless otherwise stated all prices F.O.B. Destination)	CODE	QUANTITY & UNIT	UNIT PRICE	TOTAL
Aruba 6000 PoE Managed Switch 4GB RAM 16GB Flash 24xGBE # 41327046		11	\$990.45	\$10,894.95
Aruba 6000 PoE Managed Switch 4GB RAM 16GB Flash 48xGBE # 41327042		4	\$1,373.30	\$5,493.20
*Quote Att. * State Contract - Sourcewell				
GRAND TOTAL - INCLUDING ALL ATTACHED PAGES		081419 GVC		\$16,388.15

SUBJECT TO THE FOLLOWING CONDITIONS

1. All packages, cartons or other containers must be plainly marked with the purchase order number.
2. The right is reserved to purchase in the open market and to charge the difference to the Vendor in the event that deliveries are not made at the time specified in the bid and on this order.
3. Whenever a delivery is rejected, the Vendor shall be notified and be given the reason for the rejection. All rejected deliveries shall be held at the Vendor's risk and he shall bear the expense of removal.
4. Acceptance of this order includes acceptance of all terms, prices, delivery, instructions, specifications and conditions stated.
5. The county is not liable for Federal excise tax or state sales tax.
6. Each shipment and/or each purchase order should be covered by separate invoice.

IMPORTANT: INVOICES AND PACKAGES MUST BEAR PURCHASE ORDER NUMBER

Handwritten signature/initials

VENDOR'S COPY

There is an otherwise unincumbered balance to the credit of the proper appropriation, allotment or fund to meet the expenditure covered by this purchase.

Authorized Signature

APPROVED:

Purchasing Agent



SALES QUOTE

GovConnection, Inc.
732 Milford Road
Merrimack, NH 03054

Account Executive: Jamie Stoltze
Phone: (800) 800-0019 ext. 75520
Fax: 603-683-0882
Email: jamie.stoltze@connection.com

25597391.03

PLEASE REFER TO THE ABOVE
QUOTE # WHEN ORDERING

Date: 2/20/2024
Valid Through: 3/21/2024
Account #: 1855661

Customer Contact: Jeana Money
Email: moneyj@wcde.org

Phone: (423) 753-1100
Fax:

QUOTE PROVIDED TO: AB#: 1855661 WASHINGTON COUNTY BOARD OF EDUCATION ACCOUNTS PAYABLE 405 West College Street JONESBOROUGH, TN 37659 US (423) 753-1105	SHIP TO: AB#: 12352735 WASHINGTON COUNTY SCHOOLS 306 1/2 FORREST DR TECHNOLOGY DEPARTMENT JONESBOROUGH, TN 37659 US (423) 753-1100
---	---

DELIVERY	FOB	SHIP VIA	SHIP WEIGHT	TERMS	CONTRACT ID#
5-30 Days A/R/O	Destination	UPS Ground Commercial	223.00 lbs	Net 30	SOURCEWELL RFP#081419

Important Notice: --- THIS QUOTATION IS SUBJECT TO THE FOLLOWING Terms of Sale: All purchases from GovConnection, Inc. are subject to the Terms and Conditions of our Sourcewell Contract #: RFP#081419. Any Order accepted by GovConnection for the items included in this Quotation is expressly limited to those Terms and Conditions; any other terms and conditions referenced or appearing in your Purchase Order are considered null and void. No other terms and conditions shall apply without the written consent of GovConnection, Inc. Please refer to our Quote Number in your order.

* Line #	Qty	Item #	Mfg. Part #	Description	Mfg.	Price	Ext	
1	11	41327046	R8N87A#ABA	Aruba 6000 1U RM Class 4 PoE Managed Switch ARM A9 1.016GHz / 4GB RAM / 16GB Flash / 24xGbE 370W PoE / 4xSFP Aruba HPE -	Aruba HPE	\$ 990.45	\$ 10,894.95	
2	4	41327042	R8N85A#ABA	Aruba 6000 1U RM Class 4 370W PoE Managed Switch ARM A9 1.016GHz / 4GB RAM / 16GB Flash / 48xGbE PoE / 4xGbE Aruba HPE -	Aruba HPE	\$ 1,373.30	\$ 5,493.20	
Subtotal							\$	16,388.15
Fee							\$	0.00
Shipping and Handling							\$	0.00
Tax								Exempt!
Total							\$	16,388.15



ORDERING INFORMATION
GovConnection, Inc. DBA Connection
SOURCEWELL Contract # RFP#081419
Contract Expiration: 30 October 2024

Please contact your account manager with questions.

Ordering Address
GovConnection, Inc.
732 Milford Road
Merrimack, NH 03054

Remittance Address
GovConnection, Inc.
PO Box 536477
Pittsburgh, PA 15253-5906

Please reference the Contract # on all purchase orders.

TERMS & CONDITIONS

Payment Terms:	NET 30 (subject to approved credit)
FOB Point:	DESTINATION (within Continental US)
Maximum Order Limitation:	NONE
Delivery Time:	1-30 DAYS ARO
FEIN:	52-1837891
DUNS Number:	80-967-8782
CEC:	80-068888K
Cage Code:	OGTJ3
Business Size:	LARGE

WARRANTY: Manufacturer's Standard Commercial Warranty

NOTE: It is the end user's responsibility to review, understand and agree to the terms of any End User License Agreement (EULA).

Important Notice: --- THIS QUOTATION IS SUBJECT TO THE FOLLOWING Terms of Sale: All purchases from GovConnection, Inc. are subject to the Terms and Conditions of our Sourcwell Contract # 081419. Any Order accepted by GovConnection for the items included in this Quotation is expressly limited to those Terms and Conditions; any other terms and conditions referenced or appearing in your Purchase Order are considered null and void. No other terms and conditions shall apply without the written consent of GovConnection, Inc. Please refer to our Quote Number in your order.

If you require a hard copy invoice for your credit card order, please visit the link below and click on the Proof of Purchase/Invoice link on the left side of the page to print one: <https://www.govconnection.com/web/Shopping/ProofOfPurchase.htm>

Notice on Tariff Tax Impacts: Please be aware that the pricing shown in this quote is potentially subject to change at time of order placement due Federal Government tax law changes resulting in increases in Tariff's assessed on Imports and exports, which are outside our control and the control of our suppliers. Please confirm pricing with your Account Manager prior to order placement. We apologize for this inconvenience.

Please forward your Contract or Purchase Order to:
SLEDOPS@connection.com
QUESTIONS: Call 800-800-0019
FAX: 603.683.0374

PURCHASING DEPARTMENT
WASHINGTON COUNTY BOARD OF EDUCATION

FEDERAL PROJECTS FUND
 PURCHASE ORDER

Purchase Order **35330**

Date Issued **1-24-24**

Appropriation No. **FY24 IDEAS systemic Change Grant**
 Dept. **SpEd**

School **Central Office**
Sebrena St. John

NOTICE TO VENDOR

1. Purchase order number **MUST** appear on all invoices submitted for payment.

2. Mail **TWO** copies of your invoice promptly to:

Washington County Board of Education

405 West College Street

Jonesborough, Tennessee 37659

Telephone (423) 753-1105

TO Bureau of Education & Research
 915 118th Avenue SE PO Box 96068
 Bellevue, WA 98009-9668

L Deliver to Washington County Schools
 405 West College St.
 Address Jonesborough, TN 37659

Via **ATT: Sebrena St. John**

on or before

Articles on this order must be charged to account of

ITEM NO.	ARTICLES OR SERVICES	CODE	QUANTITY & UNIT	UNIT PRICE	TOTAL
	(Unless otherwise stated all prices F.O.B. Destination)				
	Restorative Practices in the Classroom: Build Better Relationships and More Effectively manage Student behavior - by JoAnn Freiberg - 60 participants - Monday, March 11, 2024				6,130
	Reducing Disruptive Behaviors While Increasing Self-Regulation and Academic Success (Grades PK-2) - By Kristen Burke Wednesday, March 6, 2024 - 60 participants				6,041
	GRAND TOTAL - INCLUDING ALL ATTACHED PAGES				12,171

SUBJECT TO THE FOLLOWING CONDITIONS

1. All packages, cartons or other containers must be plainly marked with the purchase order number.
2. The right is reserved to purchase in the open market and to charge the difference to the Vendor in the event that deliveries are not made at the time specified in the bid and on this order.
3. Whenever a delivery is rejected, the Vendor shall be notified and be given the reason for the rejection. All rejected deliveries shall be held at the Vendor's risk and he shall bear the expense of removal.
4. No changes in or cancellations of this purchase order shall be recognized by the Vendor unless authorized by special form issued by the Purchasing Agent.
5. Acceptance of this order includes acceptance of all terms, prices, delivery, instructions, specifications and conditions stated.
6. The county is not liable for Federal excise tax or state sales tax.
7. Each shipment and/or each purchase order should be covered by separate invoice.

IMPORTANT: INVOICES AND PACKAGES MUST BEAR PURCHASE ORDER NUMBER

VENDOR'S COPY

There is an otherwise unincumbered balance to the credit of the proper appropriation, allotment or fund to meet the expenditure covered by this purchase.

Authorized Signature

APPROVED:

Purchasing Agent

FY24 IDEA Systemic Change Grant



Bureau of Education & Research

915 118th Avenue SE • PO Box 96068 • Bellevue, WA 98009-9668
Phone (800) 735-3503 • Fax (425) 453-1134 • www.ber.org

INVOICE

January 23, 2024
Contract #: OST4260
Planner: Ashley Clark
DRYT10-KNO

Bill To:

Sebrena St. John
Washington County Schools
405 West College Street
Jonesborough, TN 37659

<u>On-Site Seminar Description</u>	<u>Number of Participants</u>	<u>Contract Amount</u>
<i>RESTORATIVE PRACTICES in the Classroom: Build Better Relationships and More Effectively Manage Student Behavior</i> by JoAnn Freiberg – Monday, March 11, 2024	60	\$6130

**Non-Refundable deposit
(15% of the total contract)**

\$916

Please return your payment to:

On-Site Training Department
Bureau of Education & Research, Inc
PO Box 96068
Bellevue, WA 98009-9668



Bureau of Education & Research

915 118th Avenue SE • PO Box 96068 • Bellevue, WA 98009-9668
Phone (800) 735-3503 • Fax (425) 453-1134 • www.ber.org

INVOICE

January 23, 2024
Contract #: OST4259
Planner: Ashley Clark
DCXT04-KNO

Bill To:

Sebrena St. John
Washington County Schools
405 West College Street
Jonesborough, TN 37659

<u>On-Site Seminar Description</u>	<u>Number of Participants</u>	<u>Contract Amount</u>
<i>Reducing Disruptive Behaviors While Increasing Self-Regulation and Academic Success (Grades PK-2)</i> by Kristin Burke – Wednesday, March 6, 2024	60	\$6041

**Non-Refundable deposit
(15% of the total contract)**

\$906

Please return your payment to:

On-Site Training Department
Bureau of Education & Research, Inc
PO Box 96068
Bellevue, WA 98009-9668

BH JW JB BOE

Purchase Order **35433**

Date Issued **2-15-24**

Appropriation No. **142E72130499700**

Dept. **ARP 2.0 Homeless Grant**

School **Districtwide**

PURCHASING DEPARTMENT

WASHINGTON COUNTY BOARD OF EDUCATION

FEDERAL PROJECTS FUND

PURCHASE ORDER

TO **Barnes & Noble**
3030 Franklin Terrace

Johnson City TN 37604

Deliver to **Shannon Gray at Midway**

Address **3519 West Walnut St.**

Via **Johnson City TN 37601**

on or before

NOTICE TO VENDOR

1. Purchase order number **MUST** appear on all invoices submitted for payment.

2. Mail **TWO** copies of your invoice promptly to:

Washington County Board of Education

405 West College Street

Jonesborough, Tennessee 37659

Telephone (423) 753-1105

Articles on this order must be charged to account of

ITEM NO.	ARTICLES OR SERVICES	CODE	QUANTITY & UNIT	UNIT PRICE	TOTAL
	(Unless otherwise stated all prices F.O.B. Destination) Please see attached Quote #1616403 For \$29,348.62 List of Books - PD and student awareness concerning Homelessness. * Do Not Exceed *				
	GRAND TOTAL - INCLUDING ALL ATTACHED PAGES				29,853.75

SUBJECT TO THE FOLLOWING CONDITIONS

1. All packages, cartons or other containers must be plainly marked with the purchase order number.
2. The right is reserved to purchase in the open market and to charge the difference to the Vendor in the event that deliveries are not made at the time specified in the bid and on this order.
3. Whenever a delivery is rejected, the Vendor shall be notified and be given the reason for the rejection. All rejected deliveries shall be held at the Vendor's risk and he shall bear the expense of removal.
4. No changes in or cancellations of this purchase order shall be recognized by the Vendor unless authorized by special form issued by the Purchasing Agent.
5. Acceptance of this order includes acceptance of all terms, prices, delivery, instructions, specifications and conditions stated.
6. The county is not liable for Federal excise tax or state sales tax.
7. Each shipment and/or each purchase order should be covered by separate invoice.

IMPORTANT: INVOICES AND PACKAGES MUST BEAR PURCHASE ORDER NUMBER

VENDOR'S COPY

There is an otherwise unincumbered balance to the credit of the proper appropriation, allotment or fund to meet the expenditure covered by this purchase.

Authorized Signature

APPROVED:

Purchasing Agent



Detail

Na

- ePlan Home
- Search
- Reports
- Inbox
- Planning
- Monitoring
- Funding
- Data and Information
- Reimbursement Requests
- Project Summary
- LEA Document Library
- Address Book
- TDOE Resources
- Help for Current Page
- Contact TDOE
- ePlan Sign Out

McKinney, Hannah

Production

Session Timeout
00:23:53

Budget Detail

Washington County (900) Public District - FY 2024 - ARP Homeless 2.0 - Rev 2 - ARP Homeless 2.0

700

Return

Filtering - 2 out of 3 Budget Details match selected filters

Show All Clear All

Account Number	Line Item Number	Location Code	Tags	Narrative
72130 - Other Student ...	All	All	No Options Selected	No Options Selected

Download Budget Data

Items/Page: 10

Budget Detail

Narrative Description

Account Number: 72130 - Other Student Support

Revision 1-29-2024
Books for Professional Development and Student Awareness concerning Homelessness. Books will be stored in school libraries for Student Awareness and Professional Development books in the Schools' PD library section.

Funds are being moved from
Short Stays for homeless students \$23,600.25 72130 599
Maintenance and Repair \$3805.00 72710 338
Tires and Tubes \$2000.00 72710 450
Insurance \$4000.00 72710 511

Book title options but limited to:

Thank You Mommy Kendrick Monestime and Natalia Berezina
 Who Loves Baby Jami Kaeb
 I Sang You Down from the Stars Tasha Spillett-Sumner
 All We Can Save: Truth, Courage, and Solutions for the Climate Crisis Various Authors
 Yes! No! Megan Madison, Jessica Ralli, Isabel Roxas
 It's OK to be Different Sharon Purtil, Sasha Sujata
 Homemade Love bell hooks
 Voices from the Fields S. Beth Atkin
 When A Friend Dies Marilyn E. Gootman
 Do Hard Things Alex & Brett Harris
 We Are Displaced Malala Yousafzai
 The Cost of Knowing Brittney Morris
 Diamond Boy Michael Williams
 Can't Get There from Here Todd Strasser
 What I Carry Jennifer Longo
 Rising Trouble Maker Luvvie Alayi Jones
 My Anxious Mind Micheal A. Tompkins
 Amazing Muslims Who Changed the World Burhana Islam
 Driving Guide For Teens Arden Donovan
 Stuff That Sucks Ben Sedley
 Far From the Tree Robin Benway
 Self Love for Teen Girls Mentor Bucket
 I Would But My Damn Mind Won't Let Me Jacqui Letran
 What Does Consent Really Mean Pete Wallis & Thalia Wallis
 Three Little Words Ashley Rhodes-Courter
 Catching A Case Tina Lee
 Our Diversity Makes Us Stronger Elizabeth Cole
 Hats of Faith Medeia Cohan
 Can I Give You A Squish Emily Neilson
 Where Hands Go Krystaelynne Sanders Diggs
 Just one More Jennifer Hansen Rolli
 Dear Boy: You are Amazing Paris Rosenthal and Jason Rosenthal
 Every Child Is Different Luna James
 Dear Girl: You are Amazing Emily Green
 My Body! What I say Goes! (Indigenous Version) Jayneen Sanders
 Just Ask Sonia Sotomayor
 We Listen to Our Bodies Lydia Bowers
 Adrian Simcox Does Not Have A Horse Marcy Campbell and Corinna Luyken
 My Body! What I say goes! Jayneen Sanders
 Yard Sale Eve Bunting and Lauren Castillo
 I Can Do Hard Things: Mindful Affirmations for Kid's Gabi Garcia
 Little Spot Of Emotional Regulation, Feelings, Emotions Box Set Diane Alber
 Buddhism for Kids Emily Griffith Burke
 I Am Amazing Alissa Holder & Zulekha Holder-Young
 A Bad Case of the stripes David Shannon
 Who Loves Me Jami Kaeb
 Play Therapy Activities Charlotte Patel
 Skin Again bell hooks
 Maddi's Fridge Lois Brandt, Tamara Ryan, and Vin Vogel
 The Juneteenth Story: Celebrating the End of Slavery in the United States Alliah L. Agostini
 Count Yourself Calm Eliza Hue
 Saturday At The Food Pantry Daniel O'Neil and Brizida Macro
 Fly Away Home Eve Bunting and Ronald Himler
 Maybe Days Jennifer Wilgocki and Marcia Kahn Wrigth and Alissa Imre Geis
 The Seed of Compassion His Holiness the Dalai Lama
 Salam Alaikum A Message of Peace Harris J
 Our Daily Bread Crystal Bowman and Teri McKinley
 Jamie is Jamie Afsaneh Moradian

Line Item Number: 499 - Other Supplies and Materials

Use of Funds: Providing Academic Supports

Budget Detail

Program Code:

It's Okay to Wonder Rhonda Wagner
 Indian Children's Favorite Stories Rosemarie Somaiah
 No Fixed Address Susin Nielson
 This is Why We Pray Ameenah Muhammad-Diggins
 My Family, Your Family Lisa Bullard, Ren e Kurilla
 Christmas Eve Tree Delia Huddy and Emily Sutton
 Lily and the Paper Man Rebecca Upjohn and Renne Benoit
 Our Gracie Aunt Jacqueline Woodson and Jon Muthy
 The Sharing Circle Jessika Von Innerebner
 A Place to Stay: A Shelter Story Erin Gunti and Esteli Meza
 Bedtime Stories of Torah Values Shmuel Blitz
 Native American Stories for Kids Tom Pecore Weso
 Making A Difference Stacy C. Bauer and Emanuela Ntamack
 I Am Loved Jami Kaeb
 Timelines from Black History DK
 The Hurt Teddi Doleski
 Homecoming Cynthia Voigt
 Refuge 87 Ele Fountain
 Minna's Patchwork Coat Lauren A Mills
 Ivy Aberdeen's Letter to the World Ashley Herring Blake
 Carry Me Home Janet Fox
 The Black Foster Youth Handbook Angela Quijada-Banks
 Atheism for Kids Jessica Thorpe
 Asian American Heroes Bill O'Neill
 A Powerful Pinay for Children Melissa Leslie-Quinones
 All About China Allison Branscombe
 All About Vietnam Tran Thai Minh Phuoc
 All About Thailand Elaine Russell
 All About Japan Willamarie Moore
 All About Philippines Gidget Roceles Jimenez
 Children who Dance in the rain Susan Justice
 Ninth Ward Jewell Parker Rhodes
 Timelines from Indian History DK
 All about Indonesia Linda Hibbs
 All About Korea Ann Martin Bowler
 101 Things Every Boy Needs to Know Jamie Myers
 The Hate You Give Angie Thomas
 Tales of Two Americas Edited by John Freeman
 The American Way of Poverty Sasha Abramsky
 Broke in America Joanne Samuel Goldblum, Colleen Shaddox, Bomani Jones
 At Home on the Street Jason Adam Wasserman, Jeffrey Michael Clair
 The Pursuit of Happiness Chris Gardner
 This Is All I got Lauren Sandler
 No Room Of Her Own Desiree Hellegers
 Housing First: Ending Homelessness, Transforming Systems, and Changing Lives Deborah Padgett, Benjamin Henwood, and Sam Tsemberis
 No House To Call My Home Ryan Berg
 Tell Them Who I Am Elliot Liebow
 Handbook of Foster Youth Elizabeth Trejos-Castillo
 Foster the Family Jamie Finn
 To The End Of June Chris Beam
 Motherhood So White Nefertiti Austin
 Shattered Bonds: The Color of Child Welfare Dorothy Roberts
 The War on Kids Cara H. Drinan
 Burning Down the House: Things Get Hectic Julian E. Zelizer
 Pushout Monique W. Morris
 Delinquent Violent Youth: Theory and Interventions Thomas P. Gullppta, Gerald R. Adams, Raymond Montemayor
 Hurt 2.0: Inside the World of Today's Teenagers Chap Clark
 Youth on Trial Thomas Grisso and Robert G. Schwartz
 Why Are All the Black Kids Sitting Together in the Cafeteria Beverly Daniel Tatum, PhD
 No Matter How Loud I Shout Edward Humes
 Playing at Being Bad Micheal Ungar, PhD
 The Effective Anger Management Guide for Parents Richard Bass
 I Was Hungry Jeremy K. Everett
 Homelessness Is A Housing Problem Gregg Colburn, Clayton Page Aldern
 Catching Homelessness Josephine Ensign
 Fixer-Upper: How to repair America's broken Housing System Jenny Schuetz
 Catching Out: The Secret World of Day Laborers Dick J Reavis
 The Man in the Dog Park: Coming Up Close to Homelessness Cathy A. Small
 Things I've Learned From the Homelessness Glen Dunzweiler
 Rachel and Her Children: Homeless Families in America Johnathan Kozol
 Girlbomb Janice Erlbaum
 I'm Still Here: Black Dignity in a World Made for Whiteness Austin Channing Brown
 How to be an Antiracist Ibram X. Kendi
 White Women Regina Jackson and Saira Rao
 The Sum of Us: What Racism Costs Everyone and How We Can Prosper Together Heather McGhee
 The Uninhabitable Earth David Wallace-Wells
 How to Survive a Plague: The Inside Story of How Activists and Scientists Tamed AIDS David France
 Refusing Compulsory Sexuality: A Black Asexual Lens on Our Sex-Obsessed Culture Sherronda J. Brown
 The Laramie Project and the Laramie Project: 10 years later Moises Kaufman, Tectonic Theater Project, Leigh Fondakowski, Greg Pierotti and Andy Paris
 Children of the storm: Black Children and American Child Welfare Andrew Billingsley
 Indigenous Children's Survivance in Public Schools Leilani Sabzalian
 Nickel and Dime Barbara Ehrenreich
 Homeless but Human Rich Hebron
 The Ungrateful Refugee Dina Nayeri
 Without A Net: Middle Class and Homeless (with Kids) in America Michelle Kennedy
 Invisible Child Andrea Elliott
 The Strength in Our Scars Bianca Sparacino
 Evicted Matthew Desmond
 The LGBTQ+ History Book DK
 Come Out and Win: Organizing Yourself, Your Community, and Your World Sue Hyde

Session Timeout
00:23:53

Location Washington County (900)
Code:

Quantity:

Cost:

Budget Detail

Line Item Total: \$29,853.75

Paper Things Jennifer Richard Jacobson
 I Know Your Secret Daphne Benedis-Grab
 Isaiah Dunn Is My Hero Kelly J. Baptist
 Still A Family Brenda Reeves Sturgis and Jo-Shin Lee
 Rural Voices 15 Authors
 The Teens' Workbook to Self Regulate Richard Bass
 My Daddy The Pedophile Lily Palazzi
 DBT Skills Workbook For Teens Teen Thrive
 Coping Skills for Teens Workbook Janine Halloran
 Between the World and Me Ta-Nehisi Coates
 Just Mercy: A Story of Justice and Redemption Bryan Stevenson
 On the Other Side of Freedom DeRay McKesson
 I Know Why The Caged Bird Sings Maya Angelou
 No One Is Too Small to Make A Difference Greta Thunberg
 The Memory of Water Karen White
 The End Of The Wild Nicole Helget
 I Am Malala Malala Yousafzai with Patricia McCormick
 The Education of an Idealist Samantha Power
 Sorta Like A Rockstar Matthew Quick
 The Red Pencil Andrea Davis Pinkney
 The Beautiful Struggle Ta-Nehisi Coates
 Dear Martin Nic Stone
 Sister Outsider Audre Lorde
 Feminism is for everybody bell hooks
 Feminist Theory from the margin bell hooks
 Teaching to Transgress bell hooks

Account Number: 72130 - Other Student Support

2023 NAEHCY Conference for 2023-2024 and 2024 NAEHCY Conference SY 2024-2025 since
 Aist A NAEHCY Conference bell hooks
 Art on My Mind bell hooks
 Let Us Teach and Inspire Crownnetette McCurdy
 13 Things Mentally Strong People Don't Do Amy Morin
 The National Association of Public Child Welfare Administrators (NAACWA) is a

Line Item Number: 524 - In-Service / Staff Development

havioral and professional development association. Our mission is dedicated to ensuring educational
 Equity and Excellence in Education for all children, regardless of race, ethnicity, language, high mobility
 Children and youth through collaborative teaching leadership and capacity building of our
 Acceptance Emi Nietfeld

Session Timeout 00:23:53

Use of Funds: Staffing Supports

I'm Still Here: Loving Myself in a World Not Made for me Austin Channing Brown
 Building Tomorrow by providing technical assistance and sharing best-practice
 implementation strategies to build the capacity of individuals, agencies, and organizations to
 ensure the academic success of children. As such, we support state and federal administrators,
 homeless liaisons, educators, community service providers, advocates, parents and youth. In
 addition, we collaborate with partners to advocate for public policy change to ensure all children
 and youth succeed in school. Our members serve the approximately 1.5 million children and
 youth experiencing homelessness.
 Conference Dates November 11-14, 2023
 Hyatt New Orleans
 601 Loyola Avenue
 New Orleans, LA 70113, US
 Fees
 In-Person Registration \$948.00 (Pre-Conference and Conference)

Optional Program Code:

Location Code: Washington County (900)

Quantity: 1.00

Cost: \$15,000.00

Line Item Total: \$15,000.00

2023 Membership Benefits
 FEE This annual membership option allows for one annual membership for an individual.
 \$50.00 for 12 months.
 Free unlimited access to the annual NAEHCY Conference videos and slides following the
 conference.
 Free access to NAEHCY webinars.
 Member communications on various topics, including policy updates.
 Free access to NAEHCY Tool Kits and Resources/Guidance.
 Discounts on technical assistance.
 Opportunity to apply for service on a NAEHCY Committee as a committee member.
 Opportunity to apply for service on the NAEHCY Board of Directors.
 Full member voting rights. The annual membership meeting is held at the annual conference
 each year.
 In addition, you will receive a membership certificate and a login to access the tool kits, videos,
 slides, and other resources.
 Flight \$437.40 Nov. 10-15, 2023
 Hotel Nov.10-15, 2023, appx.\$900.00
 uber, lyft, or taxi appx. \$250
 Meals \$425

Total for filtered Budget Details: \$44,853.75

Revision 1-29-2024

Planning for Next Conference in November 2024 Total for all Budget Details: \$52,351.50

All information above for cost pp will be similar and cover 4 participants to attend the conference. Total for all Budget Details: \$97,205.25

\$8800 + \$6200.00 = \$15,000.00 Adjusted Allocation: \$97,205.25

funds are coming from the following line items Maintenance and Repair \$3805.00 72710 338

Insurance \$4,000.00 72710 511 Remaining: \$0.00

Return

Barnes & Noble Booksellers

Store 2129

Johnson City 3030 Franklin Terrace Johnson City, TN 37604

Quote # 1616403

Store Number: 2129
Prepared For: Washington County
 Twana McKinney
School/Company: WCDE
Store Contact: Amanda
Contact Phone: (865) 207-4897
Store Fax No.: (423) 952-5571
Preparation Date: 02/15/2024
Order Due Date: 02/09/2024

Shipping Address:
Customer Phone: (423) 753-1100
Customer Email: mckinneyt@wcde.org

Product	Title	Author	Publisher	Format	Discount Allowed	Destination	Quantity	List Price	% Off	Quoted Price	Extended Price
9781957590271	101 Things Every Boy Needs To Know: Important Life Advice for Teenage Boys!	Jamie Myers	Canyon Press LLC	TP	No Add'l Discount	Ship-to-Store	12	11.89	15.0%	10.11	121.32
9780062358301	13 Things Mentally Strong People Don't Do: Take Back Your Power, Embrace Change, Face Your Fears, and Train Your Brain for Happiness and Success	Amy Morin	HarperCollins Publishers	TP		Ship-to-Store	12	17.99	35.0%	11.69	140.28
9798683774288	50 People. 50 Stories. I AM ASIAN.	Kevin Wang	Independently Published	TP	No Add'l Discount	Ship-to-Store	12	19.99	5.0%	18.99	227.88
9780593489499	Acceptance: A Memoir	Emi Nietfeld	Penguin Publishing Group	TP		Ship-to-Store	12	18.00	35.0%	11.70	140.40
9780735230378	Adrian Simcox Does NOT Have a Horse	Marcy Campbell	Penguin Young Readers Group	TC		Ship-to-Store	12	18.99	35.0%	12.34	148.08
9781138821514	Ain't I a Woman: Black Women and Feminism	bell hooks	Taylor & Francis	TP	No Add'l Discount	Ship-to-Store	12	36.95	0.0%	36.95	443.40
9780804848497	All About China: Stories, Songs, Crafts and Games for Kids	Allison Branscombe	Tuttle Publishing	TC		Ship-to-Store	12	14.99	35.0%	9.74	116.88
9780804848503	All About Indonesia: Stories, Songs, Crafts and Games for Kids	Linda Hibbs	Tuttle Publishing	TC		Ship-to-Store	12	14.99	35.0%	9.74	116.88
9784805314401	All About Japan: Stories, Songs, Crafts and Games for Kids	Willamarie Moore	Tuttle Publishing	TC		Ship-to-Store	12	14.95	35.0%	9.72	116.64
9780804849388	All About Korea: Stories, Songs, Crafts and Games for Kids	Ann Martin Bowler	Tuttle Publishing	TC		Ship-to-Store	12	14.99	35.0%	9.74	116.88
9780804844277	All About Thailand: Stories, Songs, Crafts and Games for Kids	Elaine Russell	Tuttle Publishing	TC		Ship-to-Store	12	14.95	35.0%	9.72	116.64
9780804846936	All About Vietnam: Projects & Activities for Kids: Learn About Vietnamese Culture with Stories, Songs, Crafts and	Phuoc Thi Minh Tran	Tuttle Publishing	TC		Ship-to-Store	12	14.99	35.0%	9.74	116.88

Product	Title	Author	Publisher	Format	Discount Allowed	Destination	Quantity	List Price	% Off	Quoted Price	Extended Price
	Games										
9780804848480	All About the Philippines: Stories, Songs, Crafts and Games for Kids	Gidget Rocedes Jimenez	Tuttle Publishing	TC		Ship-to-Store	12	14.95	35.0%	9.72	116.64
9780593237083	All We Can Save: Truth, Courage, and Solutions for the Climate Crisis	Ayana Elizabeth Johnson	Random House Publishing Group	TP		Ship-to-Store	12	20.00	35.0%	13.00	156.00
9781568584607	American Way of Poverty: How the Other Half Still Lives	Sasha Abramsky	PublicAffairs	TP		Ship-to-Store	12	17.99	35.0%	11.69	140.28
9781565842632	Art on My Mind: Visual Politics	bell hooks	New Press, The	TP		Ship-to-Store	12	17.99	35.0%	11.69	140.28
9781588267016	At Home on the Street: People, Poverty, and a Hidden Culture of Homelessness	Jason Adam Wasserman	Lynne Rienner Publishers, Inc.	TP	No Add'l Discount	Ship-to-Store	12	22.50	5.0%	21.38	256.56
9780439598385	Bad Case of Stripes	David Shannon	Scholastic, Inc.	TP		Ship-to-Store	12	7.99	35.0%	5.19	62.28
9780812993547	Between the World and Me	Ta-Nehisi Coates	Random House Publishing Group	TC		Ship-to-Store	12	26.00	35.0%	16.90	202.80
9781735784205	Black Foster Youth Handbook: 50+ Lessons I learned to successfully Age-Out of Foster care and Holistically Heal	Ángela Quijada-Banks	Soulful Liberation	TP	No Add'l Discount	Ship-to-Store	12	34.99	0.0%	34.99	419.88
9781637743454	Broke in America: Seeing, Understanding, and Ending US Poverty	Joanne Samuel Goldblum	BenBella Books, Inc.	TP		Ship-to-Store	12	18.95	35.0%	12.32	147.84
9781594206658	Burning Down the House: Newt Gingrich, the Fall of a Speaker, and the Rise of the New Republican Party	Julian E. Zelizer	Penguin Publishing Group	TC		Ship-to-Store	12	30.00	35.0%	19.50	234.00
9781984814777	Can I Give You a Squish?	Emily Neilson	Penguin Young Readers Group	TC		Ship-to-Store	12	18.99	35.0%	12.34	148.08
9781442433571	Can't Get There from Here	Todd Strasser	Simon & Schuster Books For Young Readers	TP		Ship-to-Store	12	11.99	35.0%	7.79	93.48
9781534485099	Carry Me Home	Janet Fox	Simon & Schuster Books For Young Readers	TP		Ship-to-Store	12	8.99	35.0%	5.84	70.08
9781631521171	Catching Homelessness: A Nurse's Story of Falling Through the Safety Net	Josephine Ensign	She Writes Press	TP		Ship-to-Store	12	16.95	35.0%	11.02	132.24
9781439154809	Catching Out: The Secret World of Day Laborers	Dick J. Reavis	Simon & Schuster	TP		Ship-to-Store	12	15.99	35.0%	10.39	124.68
9780813576138	Catching a Case: Inequality and Fear in New York City's Child Welfare System	Tina Lee	Rutgers University Press	TP	No Add'l Discount	Ship-to-Store	12	38.95	30.0%	27.27	327.24
9780763679170	Christmas Eve Tree	Delia Huddy	Candlewick Press	TC		Ship-to-Store	12	16.99	35.0%	11.04	132.48
9781733387170	Coping Skills for Teens Workbook: 60 Helpful Ways to Deal with Stress, Anxiety and Anger	Janine Halloran	Encourage Play, LLC	TP		Ship-to-Store	12	19.95	15.0%	16.96	203.52

Product	Title	Author	Publisher	Format	Discount Allowed	Destination	Quantity	List Price	% Off	Quoted Price	Extended Price
9781534445468	Cost of Knowing	Britney Morris	Simon & Schuster Books For Young Readers	TP		Ship-to-Store	12	12.99	35.0%	8.44	101.28
9781784988135	Count Yourself Calm: Taking BIG Feelings to a BIG God	Eliza Huie	The Good Book Company	TC		Ship-to-Store	12	12.99	25.0%	9.74	116.88
9781914986024	DBT Skills Workbook for Teens: A Fun Guide to Manage Anxiety and Stress, Understand Your Emotions and Learn Effective Communication Skills	Teen Thrive	Teen-Thrive	TP	No Add'l Discount	Ship-to-Store	12	35.95	5.0%	34.15	409.80
9780062422514	Dear Boy: A Celebration of Cool, Clever, Compassionate You!	Paris Rosenthal	HarperCollins Publishers	TC		Ship-to-Store	12	17.99	35.0%	11.69	140.28
9780374313906	Dear Librarian	Lydia M. Sigwarth	Farrar, Straus and Giroux	TC		Ship-to-Store	12	19.99	35.0%	12.99	155.88
9781101939529	Dear Martin	Nic Stone	Random House Children's Books	TP		Ship-to-Store	12	10.99	35.0%	7.14	85.68
9780761913351	Delinquent Violent Youth: Theory and Interventions	Thomas P. Gullotta	SAGE Publications	TP	No Add'l Discount	Ship-to-Store	12	85.00	10.0%	76.50	918.00
9780316320696	Diamond Boy	Michael Williams	Little, Brown Books for Young Readers	TC		Ship-to-Store	12	18.00	35.0%	11.70	140.40
9781601428295	Do Hard Things: A Teenage Rebellion Against Low Expectations	Alex Harris	The Crown Publishing Group	TP		Ship-to-Store	12	18.00	35.0%	11.70	140.40
9780399590528	Educated: A Memoir	Tara Westover	Random House Publishing Group	TP		Ship-to-Store	12	18.99	35.0%	12.34	148.08
9780062820709	Education of an Idealist: A Memoir	Samantha Power	HarperCollins Publishers	TP		Ship-to-Store	12	18.99	35.0%	12.34	148.08
9781958350089	Effective Anger Management Guide for Parents	Richard Bass	RBG Publishing	TP		Ship-to-Store	12	24.95	35.0%	16.22	194.64
9780316245135	End of the Wild	Nicole Helget	Little, Brown Books for Young Readers	TP		Ship-to-Store	12	7.99	35.0%	5.19	62.28
9780553447453	Evicted: Poverty and Profit in the American City	Matthew Desmond	Crown Publishing Group	TP		Ship-to-Store	12	18.99	35.0%	12.34	148.08
9780062330635	Far from the Tree	Robin Benway	HarperCollins Publishers	TP		Ship-to-Store	12	11.99	35.0%	7.79	93.48
9781138821668	Feminist Theory: From Margin to Center	bell hooks	Taylor & Francis	TP	No Add'l Discount	Ship-to-Store	12	34.95	0.0%	34.95	419.40
9780060856267	First They Killed My Father: A Daughter of Cambodia Remembers	Loung Ung	HarperCollins Publishers	TP		Ship-to-Store	12	16.99	35.0%	11.04	132.48
9780815739289	Fixer-Upper: How to Repair America's Broken Housing Systems	Jenny Schuetz	Rowman & Littlefield Publishers, Inc.	TP		Ship-to-Store	12	29.99	15.0%	25.49	305.88
9780395664155	Fly Away Home	Eve Bunting	HarperCollins Publishers	TP		Ship-to-Store	12	9.99	35.0%	6.49	77.88
9781540901866	Foster the Family: Encouragement, Hope, and Practical Help for the Christian Foster Parent	Jamie C. Finn	Baker Publishing Group	TP		Ship-to-Store	12	17.99	35.0%	11.69	140.28

Product	Title	Author	Publisher	Format	Discount Allowed	Destination	Quantity	List Price	% Off	Quoted Price	Extended Price
9789811272943	From Insurgent To Citizen: World War, Insurgency, And Confrontation In Malaya And Singapore	Thomas Swee Leong Chow	World Scientific Publishing Company, Incorporated	TP		Ship-to-Store	12	28.00	18.0%	22.96	275.52
9781481465816	Genesis Begins Again	Alicia D. Williams	Athensum/Caitlyn Dlouhy Books	TP		Ship-to-Store	12	8.99	35.0%	5.84	70.08
9780812974560	Girlbomb: A Halfway Homeless Memoir	Janice Erlbaum	Random House Publishing Group	TP		Ship-to-Store	12	19.00	35.0%	12.35	148.20
9781648450822	Great Book of Asian American Heroes: 18 Asian American Men and Women Who Changed American History	Bill O'Neil	LAK Publishing	TP	No Add'l Discount	Ship-to-Store	12	11.90	15.0%	10.12	121.44
9780525553366	Hair Love	Matthew A. Cherry	Penguin Young Readers Group	TC		Ship-to-Store	12	17.99	35.0%	11.69	140.28
9781138670792	Handbook of Foster Youth	Elizabeth Trejos-Castillo	Taylor & Francis	TP	No Add'l Discount	Ship-to-Store	12	140.00	10.0%	126.00	1512.00
9780062498540	Hate U Give (Printz Honor Winner)	Angie Thomas	HarperCollins Publishers	TP		Ship-to-Store	12	16.99	35.0%	11.04	132.48
9781452173207	Hats of Faith	Medeia Cohan	Chronicle Books LLC	BD		Ship-to-Store	12	9.99	35.0%	6.49	77.88
9781495370427	Hinduism For Kids: Beliefs And Practices	Shalu Sharma	CreateSpace Publishing	TP	No Add'l Discount	Ship-to-Store	12	6.24	5.0%	5.93	71.16
9781442428782	Homcoming (Tillerman Cycle Series #1)	Cynthia Voigt	Atheneum Books for Young Readers	TP		Ship-to-Store	12	12.99	35.0%	8.44	101.28
9781732688209	Homeless but Human: Life in a Shelter	Rich Hebron	more than rich	TP		Ship-to-Store	12	16.99	35.0%	11.04	132.48
9780520383784	Homelessness Is a Housing Problem: How Structural Factors Explain U.S. Patterns	Gregg Colburn	University of California Press	TP		Ship-to-Store	12	29.95	15.0%	25.46	305.52
9780199989805	Housing First: Ending Homelessness, Transforming Systems, and Changing Lives	Deborah Padgett	Oxford University Press	TC	No Add'l Discount	Ship-to-Store	12	43.99	0.0%	43.99	527.88
9780525509301	How to Be an Antiracist	Ibram X. Kendi	Random House Publishing Group	TP		Ship-to-Store	12	18.99	35.0%	12.34	148.08
9780307745439	How to Survive a Plague: The Story of How Activists and Scientists Tamed AIDS	David France	Knopf Doubleday Publishing Group	TP		Ship-to-Store	12	21.00	35.0%	13.65	163.80
9780809165513	Hurt	Teddi Doleski	Paulist Press	TP		Ship-to-Store	12	7.95	35.0%	5.17	62.04
9780801039416	Hurt 2.0: Inside the World of Today's Teenagers	Chap Clark	Baker Publishing Group	TP		Ship-to-Store	12	25.00	35.0%	16.25	195.00
9780593327326	I Am Amazing!	Alissa Holder	Penguin Young Readers Group	TC		Ship-to-Store	12	17.99	35.0%	11.69	140.28
9780316322423	I Am Malala: The Girl Who Stood Up for Education and Was Shot by the Taliban	Malala Yousafzai	Little, Brown and Company	TP		Ship-to-Store	12	19.99	35.0%	12.99	155.88
9780998958088	I Can Do Hard Things: Mindful Affirmations for Kids	Gabi Garcia	Skinned Knee Publishing	TP		Ship-to-Store	12	12.95	15.0%	11.01	132.12
9781637312896	I Choose to Say No: A Rhyming Picture Book About Personal Body Safety.	Elizabeth Estrada	I Choose	TP	No Add'l Discount	Ship-to-Store	12	16.99	0.0%	16.99	203.88

Product	Title	Author	Publisher	Format	Discount Allowed	Destination	Quantity	List Price	% Off	Quoted Price	Extended Price
	Consent, Safe and Unsafe Touch, Private Parts, and Respectful Relationships										
9780345514400	I Know Why the Caged Bird Sings	Maya Angelou	Random House Publishing Group	MM		Ship-to-Store	12	8.99	35.0%	5.84	70.08
9781338746334	I Know Your Secret (A Secrets & Lies Novel)	Daphne Benedis-Grab	Scholastic, Inc.	TP		Ship-to-Store	12	8.99	35.0%	5.84	70.08
9780316493161	I Sang You Down from the Stars	Tasha Spillett-Sumner	Little, Brown Books for Young Readers	TC		Ship-to-Store	12	18.99	35.0%	12.34	148.08
9781587434242	I Was Hungry: Cultivating Common Ground to End an American Crisis	Jeremy K. Everett	Baker Publishing Group	TP		Ship-to-Store	12	20.00	35.0%	13.00	156.00
9780997624403	I would, but MY DAMN MIND won't let me!: A Guide for Teen Girls: How to Understand and Control Your Thoughts and Feelings	Jacqui Letran	BTHL, Inc	TP		Ship-to-Store	12	19.97	5.0%	18.97	227.64
9781982185824	I'm Glad My Mom Died	Jennette McCurdy	Simon & Schuster	TC		Ship-to-Store	12	27.99	35.0%	18.19	218.28
9780593240182	I'm Still Here (Adapted for Young Readers): Loving Myself in a World Not Made for Me	Austin Channing Brown	The Crown Publishing Group	TC		Ship-to-Store	12	18.00	35.0%	11.70	140.40
9781524760854	I'm Still Here: Black Dignity in a World Made for Whiteness	Austin Channing Brown	The Crown Publishing Group	TC		Ship-to-Store	12	25.00	35.0%	16.25	195.00
9780804850162	Indian Children's Favorite Stories: Fables, Myths and Fairy Tales	Rosemarie Somaiah	Tuttle Publishing	TC		Ship-to-Store	12	14.99	35.0%	9.74	116.88
9781138384507	Indigenous Children's Survivance in Public Schools	Leilani Sabzalian	Taylor & Francis	TP	No Add'l Discount	Ship-to-Store	12	54.95	10.0%	49.46	593.52
9780812986952	Invisible Child: Poverty, Survival, and Hope in an American City	Andrea Elliott	Random House Publishing Group	TP		Ship-to-Store	12	20.00	35.0%	13.00	156.00
9780593121399	Isaiah Dunn Is My Hero	Kelly J. Baptist	Random House Children's Books	TP		Ship-to-Store	12	8.99	35.0%	5.84	70.08
9780973410457	It's OK to be Different: A Children's Picture Book About Diversity and Kindness	Sharon Purtill	Dunhill Clare Publishing	TP		Ship-to-Store	12	10.99	15.0%	9.34	112.08
9781632963482	It's Okay to Wonder	Rhonda Wagner	Lucid Books	TP	No Add'l Discount	Ship-to-Store	12	14.99	0.0%	14.99	179.88
9781631981395	Jamie Is Jamie: A Book About Being Yourself and Playing Your Way	Afsaneh Moradian	Free Spirit Publishing	TC		Ship-to-Store	12	15.99	35.0%	10.39	124.68
9780763690458	Julián Is a Mermaid	Jessica Love	Candlewick Press	TC		Ship-to-Store	12	17.99	35.0%	11.69	140.28
9780760381991	Juneteenth Story: Celebrating the End of Slavery in the United States	Alliah L. Agostini	Epic Ink	TP		Ship-to-Store	12	9.99	35.0%	6.49	77.88

Product	Title	Author	Publisher	Format	Discount Allowed	Destination	Quantity	List Price	% Off	Quoted Price	Extended Price
9780525514121	Just Ask!: Be Different, Be Brave, Be You	Sonia Sotomayor	Penguin Young Readers Group	TC		Ship-to-Store	12	17.99	35.0%	11.69	140.28
9780812984965	Just Mercy: A Story of Justice and Redemption	Bryan Stevenson	Random House Publishing Group	TP		Ship-to-Store	12	18.00	35.0%	11.70	140.40
9780670015634	Just One More	Jennifer Hansen Rolli	Penguin Young Readers Group	TC		Ship-to-Store	12	18.99	35.0%	12.34	148.08
9780744070736	LGBTQ + History Book	DK	DK	TC		Ship-to-Store	12	27.99	35.0%	18.19	218.28
9780804170390	Laramie Project and The Laramie Project: Ten Years Later	Moises Kaufman	Knopf Doubleday Publishing Group	TP		Ship-to-Store	12	17.00	35.0%	11.05	132.60
9781897187197	Lily and the Paper Man	Rebecca Upjohn	Second Story Press	TC		Ship-to-Store	12	15.95	25.0%	11.96	143.52
9781936261291	Maddi's Fridge	Lois Brandt	Flashlight Press	TC		Ship-to-Store	12	17.95	35.0%	11.67	140.04
9781501748783	Man in the Dog Park: Coming Up Close to Homelessness	Cathy A. Small	Cornell University Press	TC		Ship-to-Store	12	22.95	35.0%	14.92	179.04
9781557988027	Maybe Days: A Book for Children in Foster Care	Jennifer Wilgocki	American Psychological Association	TP		Ship-to-Store	12	9.99	35.0%	6.49	77.88
9780451223036	Memory of Water	Karen White	Penguin Publishing Group	TP		Ship-to-Store	12	15.00	35.0%	9.75	117.00
9780316406215	Minna's Patchwork Coat	Lauren A. Mills	Little, Brown Books for Young Readers	TC		Ship-to-Store	12	17.00	35.0%	11.05	132.60
9781492679011	Motherhood So White: A Memoir of Race, Gender, and Parenting in America	Nefertiti Austin	Sourcebooks	TC		Ship-to-Store	12	25.99	35.0%	16.89	202.68
9781433804502	My Anxious Mind: A Teen's Guide to Managing Anxiety and Panic	Michael Anthony Tompkins	American Psychological Association	TP		Ship-to-Store	12	16.99	35.0%	11.04	132.48
9781925089264	My Body! What I Say Goes!	Jayneen Sanders	Educate2Empower Publishing	TP	No Add'l Discount	Ship-to-Store	12	10.95	15.0%	9.31	111.72
9781925089097	My Body! What I Say Goes! Indigenous Edition: Teach Children Body Safety, Safe/Unsafe Touch, Private Parts, Secrets/ Surprises, Consent, Respect (Int English2016)	Jayneen Sanders	Educate2empower Publishing	TP	No Add'l Discount	Ship-to-Store	12	10.95	0.0%	10.95	131.40
9780692134658	My Daddy the Pedophile: A Memoir	Lily Palazzi	Amazon Digital Services LLC - KDP Print US	TP		Ship-to-Store	12	19.99	15.0%	16.99	203.88
9781467760294	My Family, Your Family	Lisa Bullard	Lerner Publishing Group	TP	No Add'l Discount	Ship-to-Store	12	8.99	0.0%	8.99	107.88
9781638070627	Native American Stories for Kids: 12 Traditional Stories from Indigenous Tribes across North America	Tom Pecore Weso	Callisto Publishing	TP		Ship-to-Store	12	8.99	35.0%	5.84	70.08
9781250808318	Nickel and Dimed (20th Anniversary Edition): On (Not) Getting By in America	Barbara Ehrenreich	Picador	TP		Ship-to-Store	12	18.99	35.0%	12.34	148.08
9780316043083	Ninth Ward (Coretta Scott King Author Honor Title)	Jewell Parker Rhodes	Little, Brown Books for Young Readers	TP		Ship-to-Store	12	8.99	35.0%	5.84	70.08

Product	Title	Author	Publisher	Format	Discount Allowed	Destination	Quantity	List Price	% Off	Quoted Price	Extended Price
9781524768379	No Fixed Address	Susin Nielsen	Random House Children's Books	TP		Ship-to-Store	12	8.99	35.0%	5.84	70.08
9781568585680	No House to Call My Home: Love, Family, and Other Transgressions	Ryan Berg	PublicAffairs	TP		Ship-to-Store	12	21.99	35.0%	14.29	171.48
9781501102936	No Matter How Loud I Shout: A Year in the Life of Juvenile Court	Edward Humes	Simon & Schuster	TP		Ship-to-Store	12	18.99	35.0%	12.34	148.08
9780143133568	No One Is Too Small to Make a Difference	Greta Thunberg	Penguin Publishing Group	TP		Ship-to-Store	12	12.00	35.0%	7.80	93.60
9780230116580	No Room of Her Own: Women's Stories of Homelessness, Life, Death, and Resistance	D. Hellegers	Palgrave Macmillan US	TP		Ship-to-Store	12	54.99	15.0%	46.74	560.88
9780525560579	On the Other Side of Freedom: The Case for Hope	DeRay Mckesson	Penguin Publishing Group	TP		Ship-to-Store	12	17.00	35.0%	11.05	132.60
9781627073325	Our Daily Bread for Kids: 365 Meaningful Moments with God (A Daily Devotional with Bite-Size Devotions for Children Ages 6-10)	Crystal Bowman	Our Daily Bread Publishing	TC		Ship-to-Store	12	18.99	35.0%	12.34	148.08
9781737160281	Our Diversity Makes Us Stronger: Social Emotional Book for Kids about Diversity and Kindness (Children's Book for Boys and Girls)	Elizabeth Cole	Elizabeth Cole	TP	No Add'l Discount	Ship-to-Store	12	12.99	0.0%	12.99	155.88
9780763694418	Paper Things	Jennifer Richard Jacobson	Candlewick Press	TP		Ship-to-Store	12	8.99	35.0%	5.84	70.08
9781782858256	Place to Stay: A Shelter Story	Erin Gunti	Barefoot Books	TP		Ship-to-Store	10	9.99	25.0%	7.49	74.90
9780060744878	Pursuit of Happiness: An NAACP Image Award Winner	Chris Gardner	HarperCollins Publishers	TP		Ship-to-Store	12	15.99	35.0%	10.39	124.68
9781620973424	Pushout: The Criminalization of Black Girls in Schools	Monique Morris	New Press, The	TP		Ship-to-Store	12	18.95	35.0%	12.32	147.84
9780307345899	Rachel and Her Children: Homeless Families in America	Jonathan Kozol	Crown Publishing Group	TP		Ship-to-Store	12	16.00	35.0%	10.40	124.80
9780316247825	Red Pencil	Andrea Davis Pinkney	Little, Brown Books for Young Readers	TP		Ship-to-Store	12	8.99	35.0%	5.84	70.08
9780316423014	Refugee 87	Ele Fountain	Little, Brown Books for Young Readers	TP		Ship-to-Store	12	8.99	35.0%	5.84	70.08
9781623177102	Refusing Compulsory Sexuality: A Black Asexual Lens on Our Sex-Obsessed Culture	Sherronda J. Brown	North Atlantic Books	TP		Ship-to-Store	12	17.95	35.0%	11.67	140.04
9780593526033	Rising Troublemaker: A Fear-Fighter Manual for Teens	Luvvie Ajayi Jones	Penguin Young Readers Group	TC		Ship-to-Store	12	17.99	35.0%	11.69	140.28

Product	Title	Author	Publisher	Format	Discount Allowed	Destination	Quantity	List Price	% Off	Quoted Price	Extended Price
9781536226065	Rural Voices: 15 Authors Challenge Assumptions About Small-Town America	Nora Shalaway Carpenter	Candlewick Press	TP		Ship-to-Store	12	10.99	35.0%	7.14	85.68
9781481489386	Salam Alaikum: A Message of Peace	Harris J	Salaam Reads / Simon & Schuster Books for Young Readers	TC		Ship-to-Store	12	17.99	35.0%	11.69	140.28
9780807572368	Saturday at the Food Pantry	Diane O'Neill	Whitman, Albert & Company	TC		Ship-to-Store	12	18.99	35.0%	12.34	148.08
9780525555148	Seed of Compassion: Lessons from the Life and Teachings of His Holiness the Dalai Lama	Dalai Lama	Penguin Young Readers Group	TC		Ship-to-Store	12	18.99	35.0%	12.34	148.08
9780993869440	Sharing Circle	Theresa "Corky" Larsen-Jonasson	Medicine Wheel Publishing	TP		Ship-to-Store	10	12.95	35.0%	8.42	84.20
9780465070596	Shattered Bonds: The Color Of Child Welfare	Dorothy Roberts	Basic Books	TP	No Add'l Discount	Ship-to-Store	12	18.99	0.0%	18.99	227.88
9781580911863	Sister Outsider: Essays and Speeches (Commemorative Edition)	Audre Lorde	Clarkson Potter/ Ten Speed	TP		Ship-to-Store	12	17.99	35.0%	11.69	140.28
9780316412933	Skin Again	bell hooks	Little, Brown Books for Young Readers	BD		Ship-to-Store	12	7.99	35.0%	5.19	62.28
9780316043533	Sorta Like a Rock Star	Matthew Quick	Little, Brown Books for Young Readers	TP		Ship-to-Store	12	19.99	35.0%	12.99	155.88
9780275957018	Staying After School: At-Risk Students in a Compensatory Education Program	Bram A. Hamovitch	Bloomsbury Academic	TC	No Add'l Discount	Ship-to-Store	12	75.00	0.0%	75.00	900.00
9780807577073	Still a Family: A Story about Homelessness	Brenda Reeves Sturgis	Whitman, Albert & Company	TC		Ship-to-Store	12	17.99	35.0%	11.69	140.28
9781626258655	Stuff That Sucks: A Teen's Guide to Accepting What You Can't Change and Committing to What You Can	Ben Sedley	New Harbinger Publications	TP		Ship-to-Store	12	19.95	35.0%	12.97	155.64
9780525509585	Sum of Us: What Racism Costs Everyone and How We Can Prosper Together	Heather McGhee	Random House Publishing Group	TP		Ship-to-Store	12	20.00	35.0%	13.00	156.00
9780143131038	Tales of Two Americas: Stories of Inequality in a Divided Nation	John Freeman	Penguin Publishing Group	TP		Ship-to-Store	12	18.00	35.0%	11.70	140.40
9780415908085	Teaching to Transgress: Education as the Practice of Freedom	bell hooks	Taylor & Francis	TP		Ship-to-Store	12	48.95	35.0%	31.82	381.84
9781958350119	Teens' Workbook to Self Regulate	Richard Bass	RBG Publishing	TP		Ship-to-Store	12	22.95	35.0%	14.92	179.04
9780140241372	Tell Them Who I Am: The Lives of Homeless Women	Elliot Liebow	Penguin Publishing Group	TP		Ship-to-Store	12	18.00	35.0%	11.70	140.40

Product	Title	Author	Publisher	Format	Discount Allowed	Destination	Quantity	List Price	% Off	Quoted Price	Extended Price
9781685110246	Thank You, Mommy: Heartfelt Tribute of Gratitude, Appreciation, and Celebration for Selfless Mothers Everywhere	Kendrick Monestime	BLUSH Children Books	TP	No Add'l Discount	Ship-to-Store	12	12.97	5.0%	12.32	147.84
9780399589973	This Is All I Got: A New Mother's Search for Home	Lauren Sandler	Random House Publishing Group	TP		Ship-to-Store	12	18.00	35.0%	11.70	140.40
9781648760587	This is Why We Pray: A Story About Islam, Salah, and Dua	Ameenah Muhammad-Diggins	Callisto Publishing	TP		Ship-to-Store	12	9.99	35.0%	6.49	77.88
9781416948070	Three Little Words: A Memoir	Ashley Rhodes-Courter	Atheneum Books for Young Readers	TP		Ship-to-Store	12	12.99	35.0%	8.44	101.28
9780744039092	Timelines from Black History: Leaders, Legends, Legacies	DK	DK	TC		Ship-to-Store	12	19.99	35.0%	12.99	155.88
9780744054545	Timelines from Indian History: From ancient civilizations to a modern democracy	DK	DK	TC		Ship-to-Store	12	24.99	35.0%	16.24	194.88
9780544103443	To the End of June: The Intimate Life of American Foster Care	Cris Beam	HarperCollins Publishers	TP		Ship-to-Store	12	16.99	35.0%	11.04	132.48
9781777488208	To the man I loved too much: and the ones who didn't love me enough	Gabrielle G	Gabrielle Guillon	TP		Ship-to-Store	12	11.10	25.0%	8.33	99.96
9780688152857	Uncle Willie and the Soup Kitchen	DyAnne DiSalvo-Ryan	HarperCollins Publishers	TP		Ship-to-Store	12	7.99	35.0%	5.19	62.28
9781646220212	Ungrateful Refugee: What Immigrants Never Tell You	Dina Nayeri	Catapult	TP		Ship-to-Store	12	17.95	35.0%	11.67	140.04
9780525576716	Uninhabitable Earth: Life After Warming	David Wallace-Wells	Crown Publishing Group	TP		Ship-to-Store	12	18.00	35.0%	11.70	140.40
9780316056205	Voices from the Fields: Children of Migrant Farmworkers Tell Their Stories	S. Beth Atkin	Little, Brown Books for Young Readers	TP		Ship-to-Store	12	19.99	35.0%	12.99	155.88
9780190605551	War on Kids: How American Juvenile Justice Lost Its Way	Cara H. Drinan	Oxford University Press	TC		Ship-to-Store	12	29.99	35.0%	19.49	233.88
9780316523653	We Are Displaced: My Journey and Stories from Refugee Girls Around the World	Malala Yousafzai	Little, Brown Books for Young Readers	TP		Ship-to-Store	12	11.99	35.0%	7.79	93.48
9780399581816	We Are Everywhere: Protest, Power, and Pride in the History of Queer Liberation	Matthew Riemer	Clarkson Potter/Ten Speed	TC		Ship-to-Store	12	40.00	35.0%	26.00	312.00
9781631985003	We Listen to Our Bodies	Lydia Bowers	Free Spirit Publishing	TC		Ship-to-Store	12	15.99	35.0%	10.39	124.68
9781848193307	What Does Consent Really Mean?	Pete & Thalia Wallis	Jessica Kingsley Publishers	TC		Ship-to-Store	12	23.95	35.0%	15.57	186.84
9780553537741	What I Carry	Jennifer Longo	Random House Children's Books	TP		Ship-to-Store	12	11.99	35.0%	7.79	93.48

Product	Title	Author	Publisher	Format	Discount Allowed	Destination	Quantity	List Price	% Off	Quoted Price	Extended Price
9781631984228	When a Friend Dies: A Book for Teens About Grieving & Healing	Marilyn E. Gootman	Free Spirit Publishing	TP		Ship-to-Store	12	12.99	35.0%	8.44	101.28
9798532393004	Where Hands Go	Krystaelynn Sanders Diggs	Krystaelynn Sanders Diggs	TP	No Add'l Discount	Ship-to-Store	12	10.99	10.0%	9.89	118.68
9780415929134	Where We Stand: Class Matters	bell hooks	Taylor & Francis	TP		Ship-to-Store	12	48.95	35.0%	31.82	381.84
9780143136439	White Women: Everything You Already Know About Your Own Racism and How to Do Better	Regina Jackson	Penguin Publishing Group	TP		Ship-to-Store	12	16.00	35.0%	10.40	124.80
9780465060689	Why Are All the Black Kids Sitting Together in the Cafeteria?: And Other Conversations about Race	Beverly Daniel Tatum	Basic Books	TP		Ship-to-Store	12	21.99	35.0%	14.29	171.48
9780143036784	Without a Net: Middle Class and Homeless (with Kids) in America	Michelle Kennedy	Penguin Publishing Group	TP		Ship-to-Store	12	14.00	35.0%	9.10	109.20
9780763693053	Yard Sale	Eve Bunting	Candlewick Press	TP		Ship-to-Store	12	7.99	35.0%	5.19	62.28
9780226309132	Youth on Trial: A Developmental Perspective on Juvenile Justice	Thomas Grisso	University of Chicago Press	TP	No Add'l Discount	Ship-to-Store	12	32.00	0.0%	32.00	384.00

By placing this order, I acknowledge and understand that all items are non-returnable.

Subtotal: \$29348.62
Shipping: \$0.00
Sales Tax: \$0.00
Total: \$29348.62

Please direct any questions to Amanda at (865) 207-4897 or CRM2129@bn.com.

Price valid through 03/16/2024. Delivery date depends upon date of order. Additional fees may apply.

Quantities subject to availability at time of order.

Please make checks payable to "Barnes & Noble" and present your Tax Exempt certificate at payment.

If charging to an Institutional Account. Please present your Institutional Account Card and Tax Exempt certificate at payment. OR provide a Purchase Order indicating your Account Number and Tax Exempt information.

Proposal
For
Washington County School Board
Addressing uncontrolled stormwater discharges at
Ridgeview Elementary School

Recommendations to address drainage:

- 1) Fully design and construct proposed functioning retention basin to replace the existing structures and basin that is currently not functioning properly.
- 2) Install proper discharge control structures in the newly designed retention pond to control outflow rate at current storm water TDEC standards.
- 3) Design and install functioning diversion ditches along property boundary line to capture the current storm water that is being discharged in an uncontrolled manner. These ditches will help direct current uncontrolled storm water to the updated and functioning retention basin.
- 4) Redesign drainage/grading plan to direct all drainage possible to the new properly functioning retention basin.
- 5) The proposed grading will create some grub, brush and trees that will need to be removed and disposed. Any burning will take place along the property line below the proposed retention basin. Any burning would take place outside of school hours and coordinated with Jarrod Adams.
- 6) Stabilization of all disturbed areas for proposed work.

Timeline for conducting all work:

- 1) Engineering design work for proposed work is currently underway.
- 2) The estimated time of construction would be over a 6-week time frame.
- 3) Proposed work to be completed by August of 2024 (Assuming no delays in approval) - we target completing the majority of work over the scheduled summer break.
- 4) Proposed work to be scheduled and coordinated with Jarrod Adams.

Proposal:

- 1) Landstar will cause all the work described above to be properly done and in a timely manner at its own expense.
- 2) Landstar will burn adjoining property brush at the joining property line while completing proposed work.
- 3) Landstar will receive credit for a charitable donation to the school board reflecting "fair market value" for completed work that is performed from the agreed proposal.



THIS DRAWING IS THE PROPERTY OF BENCHMARK DESIGN, PLC. ANY USE, REUSE, REPRODUCTION, DISPLAY OR SALE OF THIS DRAWING WITHOUT THE EXPRESS WRITTEN CONSENT OF THE ENGINEER IS STRICTLY PROHIBITED.

E:\2023 Projects\23113 KEEBLER REVISION Drawings\23113 BASE - Soil Quantities.dwg, 2/19/2024 10:26:16 AM, 1'

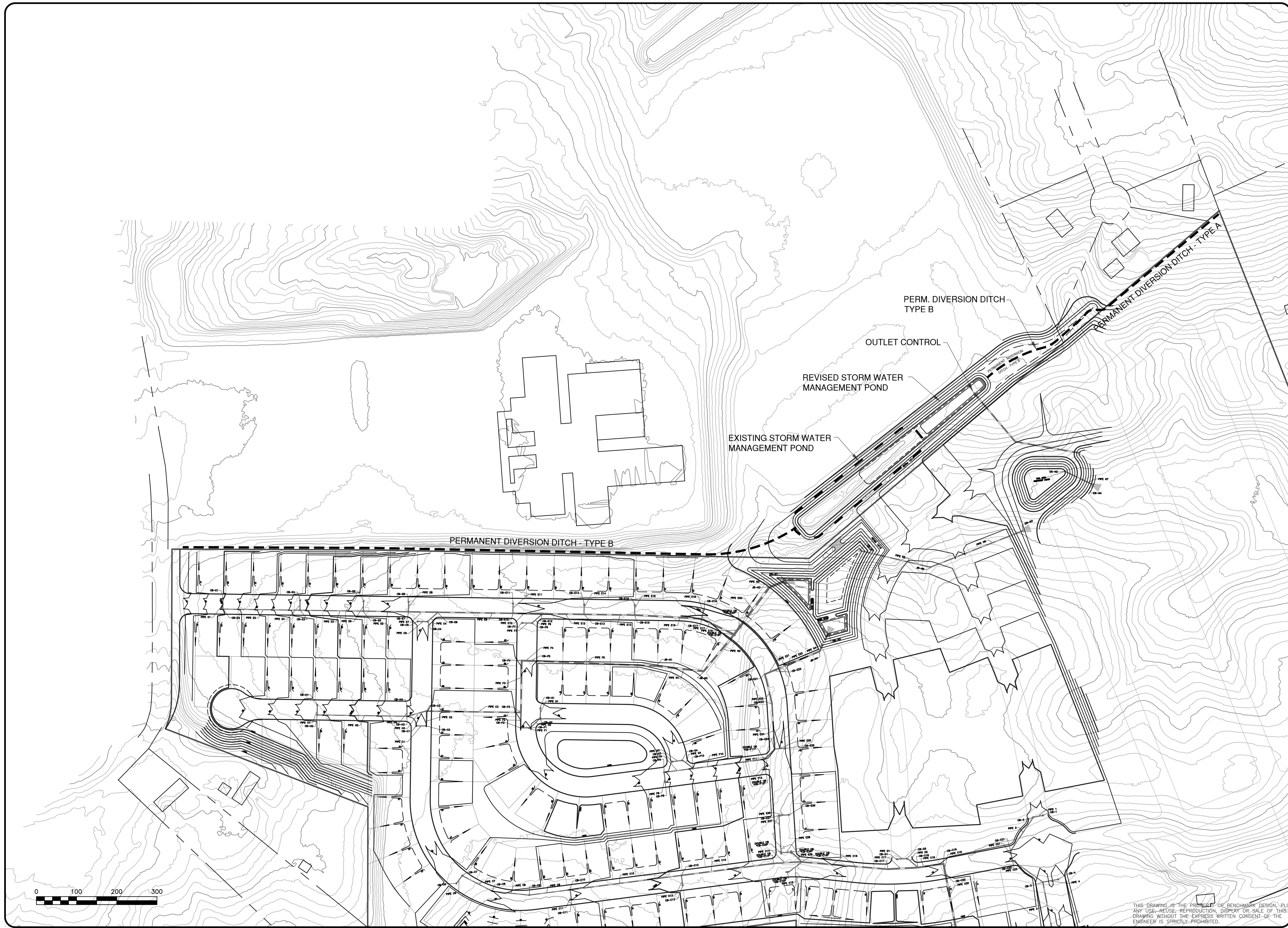

THIS DRAWING IS THE PROPERTY OF BENCHMARK DESIGN, PLC. ANY USE, REUSE, REPRODUCTION, DISPLAY OR SALE OF THIS DRAWING WITHOUT THE EXPRESS WRITTEN CONSENT OF THE ENGINEER IS STRICTLY PROHIBITED.

E:\2023 Projects\23113 KEEBLER REVISION\Drawings\23113 BASE - OFFSITE DRAINAGE.dwg, 2/22/2024 8:46:53 AM, 1'

DOCUMENT 00 41 00 - BID FORM

TO: Lewis Group Architects, Inc.
6512 Deane Hill Drive
Knoxville, TN 37919

FROM: Skilled Services
2900 Hoitt Ave
Knoxville, TN 37917

FOR: Washington County Schools
Security Upgrades
Sulphur Springs Elementary School
LGA# 22052
405 W. College Street
Jonesborough, TN 37659

Pursuant to and in compliance with the Invitation to Bid, the Instructions to Bidders, and other documents relating thereto, the undersigned hereby proposes to furnish all labor and materials and perform all work complete for the construction of the project required by and in strict conformance with the Contract Documents consisting of the Drawings, the Project Manual, and

Addendum No. <u>1</u> dated <u>10/26/23</u>	Addendum No. <u>4</u> dated <u>1/26/24</u>
Addendum No. <u>2</u> dated <u>1/9/24</u>	Addendum No. <u> </u> dated <u> </u>
Addendum No. <u>3</u> dated <u>1/16/24</u>	Addendum No. <u> </u> dated <u> </u>

In submitting this bid the Bidders acknowledge that they have received, read, and understand the bid documents, have visited the site and become familiar with conditions under which work will be performed, have correlated observations with requirements of Bid Documents, and make this bid in accordance therewith.

In submitting the Bid the Bidder agrees to:

1. Honor this bid for 60 days from date of bid opening.
2. Enter into and execute a contract if presented on the basis of this bid and furnish certificate(s) of insurance, bonds and other documents related to the contract as required by the Bidding Documents.
3. Accomplish work in accordance with the Contract Documents.

LEWIS GROUP ARCHITECTS
LGA# 22052

Washington County Schools - Security Upgrades
10/02/2023
Addendum 01 – 10/16/2023

LEWIS GROUP ARCHITECTS
LGA# 22052

Washington County Schools - Security Upgrades
10/02/2023
Sulphur Springs Elementary School – 01/09/2024

4. Perform additional work by Change Order under the terms of the contract using the actual cost of the work plus ten percent (10%) for overhead and five percent (5%) for profit.
5. Achieve Substantial Completion of the Work within 120 (by contractor) calendar days from and including the date stipulated in the Notice to Proceed.
6. Attach fully executed affidavits (found in the Project Manual) with the Bid Form as follows:
 - a. 00 41 13 Drug-Free Workplace Affidavit. Have a drug free workplace program as required by this document.
 - b. 00 45 13 Affidavit of Compliance with Non-Collusion of Prime Bidder.
 - c. 00 45 59 Tennessee Criminal History Check Affidavit.
7. Contractor shall comply with Public Chapter 587 of 2007, as codified in Tennessee Code Annotated Section 49-5-413, which requires all contractors to facilitate a criminal history records check conducted by the Tennessee Bureau of Investigation and the Federal Bureau of Investigation for each employee prior to permitting the employee to have contact with students or enter school grounds when students are present.

Complete the Work of this project for the Lump Sum of:

BASE BID :

two hundred forty nine thousand, five hundred and zero /100ths
 Dollars
 (Amount shown in both words and figures) \$ 249,500⁰⁰

Alternate 1:

twelve thousand, two hundred and zero /100ths
 Dollars
 (Amount shown in both words and figures) \$ 12,200⁰⁰
 Additional days
 (if required) n/a

NAME OF FIRM Skilled Services

SIGNED BY [Signature]

NAME: ROBERT SMITH TITLE President

BIDDER'S ADDRESS 2800 Hoitt Ave
STREET

Knorrville CITY TN STATE 37917 ZIP CODE

TELEPHONE 865.637.7687

CONTRACTOR'S LICENSE NO: 34266 Dollar Limit: Unlimited

EXPIRATION DATE: 11 / 30 / 2024
MM / DD / YYYY

END OF DOCUMENT

DOCUMENT 00 41 13 - DRUG-FREE WORKPLACE AFFIDAVIT

STATE OF TN

COUNTY OF Knox

The undersigned, principal officer of Skilled Services, the Contractor, an employer of five (5) or more employees contracting with Washington County Schools, to provide construction services, hereby states under oath as follows:

1. The undersigned is a principal officer of the Contractor and is duly authorized to execute this Affidavit on behalf of the Company.
2. The Contractor submits this Affidavit pursuant to Tennessee Code Annotated (TCA) § 50-9-113, which requires each employer with five or more employees receiving pay who contracts with the state to provide construction services to submit an affidavit stating that such employer has a drug-free workplace program that complies with TCA Title 50, Chapter 9.
3. The Company is in compliance with TCA § 50-9-113.

Further affidavit saith not.

[Signature]
Principal Officer

STATE OF TN

COUNTY OF Knox

Before me personally appeared Rob Smith, with whom I am personally acquainted (or proved to me on the basis of satisfactory evidence), and who acknowledged that such person executed the foregoing affidavit for the purposes therein contained.

Witness my hand and seal at office this 1st day of February, 2024.

[Signature]
Notary Public

My commission expires: 4.10.2027



END OF AFFIDAVIT

AFFIDAVIT OF COMPLIANCE

WITH

NON-COLLUSION OF PRIME BIDDER

STATE OF TENNESSEE

COUNTY OF WASHINGTON

Rob Smith, being first duly sworn, deposes and says that:

1. He/She is President of Skilled Services, the Bidder that has submitted the attached Bid;

2. He/She is fully informed respecting the preparation and contents of the attached Bid and of all pertinent circumstances respecting such Bid;

3. Such Bid is genuine and is not a collusive or sham Bid;

4. Neither the said Bidder nor any of its officers, partners, owners, agents, representatives, employees or parties in interest, including this affiant, has in any way colluded, conspired, connived, or agreed, directly or indirectly with any other Bidder, firm or person to submit a collusive or sham Bid in connection with the Contract for which the attached Bid has been submitted or to refrain from bidding in connection with such Contract, or has in any manner, directly or indirectly, sought by agreement or collusion or communication or conference with any other bidder, firm or person to fix the price or prices in the attached Bid or of any other bidder, or to secure through any other bidder, or to fix any overhead, profit or cost element of the bid price or the bid price of any other bidder, or to secure through any collusion, conspiracy, connivance or unlawful agreement any advantage against Washington County, TN or any person interested in the proposed contract; and

5. The price or prices quoted in the attached Bid are fair and proper and are not tainted by a collusion, conspiracy, connivance, or unlawful agreement on the part of the Bidder or any of its agents, representatives, owners, employees, or parties in interest, including this affiant.

(signed) [Signature]
President
(title)

Subscribed and sworn to before me this 1st day of February, 2023

[Signature]
(signature)

My commission expires 4.10.2027

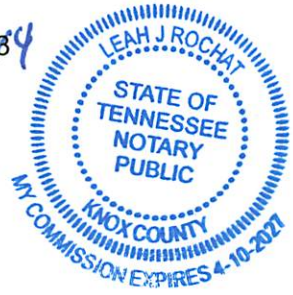

DOCUMENT 00 41 13.03 AFFIDAVIT OF COMPLIANCE WITH TENNESSEE CRIMINAL HISTORY RECORDS CHECK

TENNESSEE CODE ANNOTATED, SECTION 49-5-413

(To be submitted with bid by contractor)

I, Rob Smith, president or other principal

Officer of Skilled Services, swear or affirm that the
Name of Company

Company is in compliance with Public Chapter 587 of 2007, codified at Tennessee Code Annotated 49-5-413, in effect at the time of this bid submission at least to the extent required of governmental entities. I further swear or affirm that the company is in compliance with Tennessee Code Annotated, § 49-5-413.



President or Principal Officer

For: Skilled Services
Name of Company

STATE OF TENNESSEE }
COUNTY OF }

Subscribed and sworn before me by Rob Smith,

President or Principal Officer of Skilled Services,

On this 1st day of February, 2024.

Leah J. Rochat
Notary Public

My Commission expires: 4.10.2027

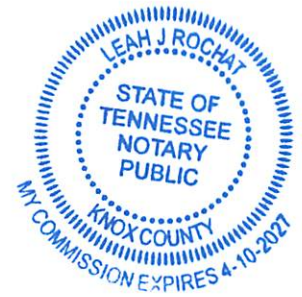

END OF DOCUMENT

DOCUMENT 00 45 59 - CRIMINAL HISTORY CHECK

Contractor shall comply with Public Chapter 587 of Public Acts, 2007, as codified in Tennessee Code Annotated Section 49-5-413, which requires all contractors to facilitate a criminal history records check conducted by the Tennessee Bureau of Investigation and the Federal Bureau of Investigation for each employee prior to permitting the employee to have contact with students or enter school grounds when students are present.

AN ACT to amend Tennessee Code Annotated, Section 49-5-413, relative to contracting with certain persons who may have contact with certain children.

BE IT ENACTED BY THE GENERAL ASSEMBLY OF THE STATE OF
TENNESSEE:

SECTION 1. Tennessee Code Annotated, Section 49-5-413, is amended by adding the following new subsection:

(d) (1) Any person, corporation or other entity who enters into or renews a contract with a local board of education or childcare program as defined in Section 49-1-1102 on or after the effective date of this act shall be required to comply with the provisions of this subsection if the contract requires:

(A) The person or an employee of the person, corporation or other entity to have direct contact with school children or to children in a childcare program; or

(B) The person or employee access to the grounds of a school or childcare center when children are present.

(2) It is the duty of the person, corporation or other entity who employs a person described in subdivision (1) to require such applicant to supply a fingerprint sample and submit to a criminal history records check to be conducted by the Tennessee Bureau of Investigation and the Federal Bureau of Investigation prior to permitting the person to have contact with such children or enter school grounds.

(3) (A) No employer, or employee of such employer to whom this subsection applies shall come in direct contact with school children or to children in a childcare program or enter the grounds of a school or childcare center when children are present until the criminal history records check has been conducted on such person.

(B) No employer, or employee of such employer, to whom this subsection applies shall come in direct contact with school children or to children in a childcare program or enter the grounds of a school or childcare center when children are present if the criminal history records check indicates that the employer or employee has been convicted of an offense that, if committed on or after July 1, 2007, is classified as a sexual offense in Section 40-39-202(17) or violent sexual offender in Section 40-39-202(25). (B) (i) If an employee is convicted of an offense that, if committed on or after July 1, 2007, is a sexual offense as defined in Section 40-39-202(17) or a violent sexual offense as defined in Section 40-39-202(25), after the employer has conducted a criminal history records check on such employee, the employee shall notify the employer of such conviction within seven (7) days from the date of conviction.

(ii) An employee commits a Class A misdemeanor, punishable by fine only, who knowingly fails to disclose to the employer within the required seven (7) days that the employee has been convicted of an offense specified in subdivision (C) (i).

(4) The provisions of this subsection shall only apply if the employer or employee of such employer comes in direct contact with school children, children in a childcare program or enter the grounds of a school or childcare center when children are present during the ordinary course of performing a function required or permitted by the terms of the contract. Any action involving direct contact or entry by an employee which is outside such ordinary course of performing a function required or permitted by the terms of the contract shall not in any way be deemed to be authorized or approved by the employer and such employer shall not in any way be deemed to be liable for such contact or entry, vicariously or otherwise. However, nothing in this subsection shall authorize such contact or entry by an employer or employee of such employer if contact or entry is prohibited by any other provision of law; provided that with respect to such contact or entry, the person, corporation, or other entity who employs a person described in subdivision (1) shall not in any way be deemed to be liable, vicariously, or otherwise, for any such actions taken by the employee unless such employer has actual knowledge that such other provision of law prohibits contact or entry by an employee.

SECTION 2. This act shall take effect September 1, 2007, the public welfare requiring it and shall apply to all applicable contracts entered into or renewed on or after the effective date of this act.

END OF DOCUMENT

A handwritten signature in blue ink, consisting of a stylized, cursive letter 'R' followed by a horizontal line extending to the right.

Document A310™ – 2010

Conforms with The American Institute of Architects AIA Document 310

Bid Bond

CONTRACTOR:

(Name, legal status and address)

Skilled Services Quality Construction, LLC
2800 Hoitt Ave.
Knoxville, TN 37917

OWNER:

(Name, legal status and address)

Washington County Schools
405 West College Street
Jonesborough, TN 37659

SURETY:

(Name, legal status and principal place of business)

Westfield Insurance Company
P.O. Box 5001
Westfield Center, OH 44251-5001
Mailing Address for Notices
P.O. Box 5001
Westfield Center, OH 44251-5001

This document has important legal consequences. Consultation with an attorney is encouraged with respect to its completion or modification.

Any singular reference to Contractor, Surety, Owner or other party shall be considered plural where applicable.

BOND AMOUNT: 5% Five Percent of Amount Bid

PROJECT:

(Name, location or address, and Project number, if any)

WCS - SULPHUR SPRINGS SECURITY VESTIBULES

The Contractor and Surety are bound to the Owner in the amount set forth above, for the payment of which the Contractor and Surety bind themselves, their heirs, executors, administrators, successors and assigns, jointly and severally, as provided herein. The conditions of this Bond are such that if the Owner accepts the bid of the Contractor within the time specified in the bid documents, or within such time period as may be agreed to by the Owner and Contractor, and the Contractor either (1) enters into a contract with the Owner in accordance with the terms of such bid, and gives such bond or bonds as may be specified in the bidding or Contract Documents, with a surety admitted in the jurisdiction of the Project and otherwise acceptable to the Owner, for the faithful performance of such Contract and for the prompt payment of labor and material furnished in the prosecution thereof; or (2) pays to the Owner the difference, not to exceed the amount of this Bond, between the amount specified in said bid and such larger amount for which the Owner may in good faith contract with another party to perform the work covered by said bid, then this obligation shall be null and void, otherwise to remain in full force and effect. The Surety hereby waives any notice of an agreement between the Owner and Contractor to extend the time in which the Owner may accept the bid. Waiver of notice by the Surety shall not apply to any extension exceeding sixty (60) days in the aggregate beyond the time for acceptance of bids specified in the bid documents, and the Owner and Contractor shall obtain the Surety's consent for an extension beyond sixty (60) days.

If this Bond is issued in connection with a subcontractor's bid to a Contractor, the term Contractor in this Bond shall be deemed to be Subcontractor and the term Owner shall be deemed to be Contractor.

When this Bond has been furnished to comply with a statutory or other legal requirement in the location of the Project, any provision in this Bond conflicting with said statutory or legal requirement shall be deemed deleted herefrom and provisions conforming to such statutory or other legal requirement shall be deemed incorporated herein. When so furnished, the intent is that this Bond shall be construed as a statutory bond and not as a common law bond.

Signed and sealed this 1st day of February, 2024.



(Witness)



(Witness) Sue Hill

Skilled Services Quality Construction, LLC
(Principal) _____ (Seal)

By: 

(Title)

Westfield Insurance Company
(Surety) _____ (Seal)

By: 

(Title) Kendra Adams, Attorney-in-Fact

General
Power
of Attorney

CERTIFIED COPY

POWER NO. 4111931 05

Westfield Insurance Co.
Westfield National Insurance Co.
Ohio Farmers Insurance Co.
Westfield Center, Ohio

Know All Men by These Presents, That WESTFIELD INSURANCE COMPANY, WESTFIELD NATIONAL INSURANCE COMPANY and OHIO FARMERS INSURANCE COMPANY, corporations, hereinafter referred to individually as a "Company" and collectively as "Companies," duly organized and existing under the laws of the State of Ohio, and having its principal office in Westfield Center, Medina County, Ohio, do by these presents make, constitute and appoint
ALEXANDER C. SHAFER, JASON E. TALLENT, AARON JENSEN, CHRISTINA ADDINGTON, CHRISTIE SWINNEY, SUE HILL, KENDRA ADAMS, JOINTLY OR SEVERALLY

of KNOXVILLE and State of TN its true and lawful Attorney(s)-in-Fact, with full power and authority hereby conferred in its name, place and stead, to execute, acknowledge and deliver any and all bonds, undertakings, and recognizances; provided, however, that the penal sum of any one such instrument executed hereunder shall not exceed FIFTEEN MILLION DOLLARS AND NO CENTS (\$15,000,000)---

LIMITATION: THIS POWER OF ATTORNEY CANNOT BE USED TO EXECUTE NOTE GUARANTEE, MORTGAGE DEFICIENCY, MORTGAGE GUARANTEE, OR BANK DEPOSITORY BONDS.

and to bind any of the Companies thereby as fully and to the same extent as if such bonds were signed by the President, sealed with the corporate seal of the applicable Company and duly attested by its Secretary, hereby ratifying and confirming all that the said Attorney(s)-in-Fact may do in the premises. Said appointment is made under and by authority of the following resolution adopted by the Board of Directors of each of the WESTFIELD INSURANCE COMPANY, WESTFIELD NATIONAL INSURANCE COMPANY and OHIO FARMERS INSURANCE COMPANY:

"Be it Resolved, that the President, any Senior Executive, any Secretary or any Fidelity & Surety Operations Executive or other Executive shall be and is hereby vested with full power and authority to appoint any one or more suitable persons as Attorney(s)-in-Fact to represent and act for and on behalf of the Company subject to the following provisions:

The Attorney-in-Fact may be given full power and authority for and in the name of and on behalf of the Company, to execute, acknowledge and deliver, any and all bonds, recognizances, contracts, agreements of indemnity and other conditional or obligatory undertakings and any and all notices and documents canceling or terminating the Company's liability thereunder, and any such instruments so executed by any such Attorney-in-Fact shall be as binding upon the Company as if signed by the President and sealed and attested by the Corporate Secretary."

"Be it Further Resolved, that the signature of any such designated person and the seal of the Company heretofore or hereafter affixed to any power of attorney or any certificate relating thereto by facsimile, and any power of attorney or certificate bearing facsimile signatures or facsimile seal shall be valid and binding upon the Company with respect to any bond or undertaking to which it is attached." (Each adopted at a meeting held on February 8, 2000).

In Witness Whereof, WESTFIELD INSURANCE COMPANY, WESTFIELD NATIONAL INSURANCE COMPANY and OHIO FARMERS INSURANCE COMPANY have caused these presents to be signed by their National Surety Leader and Senior Executive and their corporate seals to be hereto affixed this 14th day of JULY A.D., 2023 .

Corporate
Seals
Affixed



WESTFIELD INSURANCE COMPANY
WESTFIELD NATIONAL INSURANCE COMPANY
OHIO FARMERS INSURANCE COMPANY

By: Gary W. Stumper, National Surety Leader and Senior Executive

State of Ohio
County of Medina ss.:

On this 14th day of JULY A.D., 2023 , before me personally came Gary W. Stumper to me known, who, being by me duly sworn, did depose and say, that he resides in Medina, OH; that he is National Surety Leader and Senior Executive of WESTFIELD INSURANCE COMPANY, WESTFIELD NATIONAL INSURANCE COMPANY and OHIO FARMERS INSURANCE COMPANY, the companies described in and which executed the above instrument; that he knows the seals of said Companies; that the seals affixed to said instrument are such corporate seals; that they were so affixed by order of the Boards of Directors of said Companies; and that he signed his name thereto by like order.

Notarial
Seal
Affixed



David A. Kotnik, Attorney at Law, Notary Public
My Commission Does Not Expire (Sec. 147.03 Ohio Revised Code)

State of Ohio
County of Medina ss.:

I, Frank A. Carrino, Secretary of WESTFIELD INSURANCE COMPANY, WESTFIELD NATIONAL INSURANCE COMPANY and OHIO FARMERS INSURANCE COMPANY, do hereby certify that the above and foregoing is a true and correct copy of a Power of Attorney, executed by said Companies, which is still in full force and effect; and furthermore, the resolutions of the Boards of Directors, set out in the Power of Attorney are in full force and effect.

In Witness Whereof, I have hereunto set my hand and affixed the seals of said Companies at Westfield Center, Ohio, this 1st day of February A.D., 2024 .

Frank A. Carrino, Secretary

DOCUMENT 00 41 00 - BID FORM

TO: Lewis Group Architects, Inc.
6512 Deane Hill Drive
Knoxville, TN 37919

FROM: Hoilman Construction Company, Inc.
513 Twin Oaks Drive
Johnson City, TN 37601

FOR: Washington County Schools
Security Upgrades
Sulphur Springs Elementary School
LGA# 22052
405 W. College Street
Jonesborough, TN 37659

Pursuant to and in compliance with the Invitation to Bid, the Instructions to Bidders, and other documents relating thereto, the undersigned hereby proposes to furnish all labor and materials and perform all work complete for the construction of the project required by and in strict conformance with the Contract Documents consisting of the Drawings, the Project Manual, and

Addendum No. 01 dated 10/16/2023 Addendum No. 04 dated 1/26/2024
Addendum No. 02 dated 1/9/2024 Addendum No. dated
Addendum No. 03 dated 1/16/2024 Addendum No. dated

In submitting this bid the Bidders acknowledge that they have received, read, and understand the bid documents, have visited the site and become familiar with conditions under which work will be performed, have correlated observations with requirements of Bid Documents, and make this bid in accordance therewith.

In submitting the Bid the Bidder agrees to:

1. Honor this bid for 60 days from date of bid opening.
2. Enter into and execute a contract if presented on the basis of this bid and furnish certificate(s) of insurance, bonds and other documents related to the contract as required by the Bidding Documents.
3. Accomplish work in accordance with the Contract Documents.

LEWIS GROUP ARCHITECTS
LGA# 22052

Washington County Schools - Security Upgrades
10/02/2023
Addendum 01 – 10/16/2023

LEWIS GROUP ARCHITECTS
LGA# 22052

Washington County Schools - Security Upgrades
10/02/2023
Sulphur Springs Elementary School – 01/09/2024

4. Perform additional work by Change Order under the terms of the contract using the actual cost of the work plus ten percent (10%) for overhead and five percent (5%) for profit.
5. Achieve Substantial Completion of the Work within 150 (by contractor) calendar days from and including the date stipulated in the Notice to Proceed.
6. Attach fully executed affidavits (found in the Project Manual) with the Bid Form as follows:
 - a. 00 41 13 Drug-Free Workplace Affidavit. Have a drug free workplace program as required by this document.
 - b. 00 45 13 Affidavit of Compliance with Non-Collusion of Prime Bidder.
 - c. 00 45 59 Tennessee Criminal History Check Affidavit.
7. Contractor shall comply with Public Chapter 587 of 2007, as codified in Tennessee Code Annotated Section 49-5-413, which requires all contractors to facilitate a criminal history records check conducted by the Tennessee Bureau of Investigation and the Federal Bureau of Investigation for each employee prior to permitting the employee to have contact with students or enter school grounds when students are present.

Complete the Work of this project for the Lump Sum of:

BASE BID :

Two hundred sixty-three thousand seven hundred no /100ths
Dollars ~~thirty-five~~
(Amount shown in both words and figures) \$ 263,735.00

Alternate 1: ADD:

One thousand five hundred twenty-six ----- and no /100ths
Dollars
(Amount shown in both words and figures) ADD: \$ 1,526.00
Additional days
(if required) None Required

NAME OF FIRM Hoilman Construction Company, Inc.

SIGNED BY 

NAME: Doug Hoilman President
TITLE

BIDDER'S ADDRESS 513 Twin Oaks Drive
STREET
Johnson City, TN 37601

CITY STATE ZIP CODE

TELEPHONE (423) 926-1297 or 926-0596

CONTRACTOR'S LICENSE NO: 26587 Dollar Limit: Unlimited

EXPIRATION DATE: 07 / 31 / 2025
MM / DD / YYYY

END OF DOCUMENT

DOCUMENT 00 41 13 - DRUG-FREE WORKPLACE AFFIDAVIT

STATE OF TENNESSEE

COUNTY OF WASHINGTON

The undersigned, principal officer of Hoilman Construction Company, Inc., the Contractor, an employer of five (5) or more employees contracting with Washington County Schools, to provide construction services, hereby states under oath as follows:

1. The undersigned is a principal officer of the Contractor and is duly authorized to execute this Affidavit on behalf of the Company.
2. The Contractor submits this Affidavit pursuant to Tennessee Code Annotated (TCA) § 50-9-113, which requires each employer with five or more employees receiving pay who contracts with the state to provide construction services to submit an affidavit stating that such employer has a drug-free workplace program that complies with TCA Title 50, Chapter 9.
3. The Company is in compliance with TCA § 50-9-113.

Further affidavit saith not.



Principal Officer
Doug Hoilman, President

STATE OF Tennessee

COUNTY OF Washington

Before me personally appeared Doug Hoilman, with whom I am personally acquainted (or proved to me on the basis of satisfactory evidence), and who acknowledged that such person executed the foregoing affidavit for the purposes therein contained.

Witness my hand and seal at office this 1st day of February, 2024.



Notary Public

My commission expires: 12/20/2027

END OF AFFIDAVIT



AFFIDAVIT OF COMPLIANCE

WITH

NON-COLLUSION OF PRIME BIDDER

STATE OF TENNESEE

COUNTY OF WASHINGTON

Doug Hoilman, being first duly sworn, deposes and says that:

1. He/~~She~~ is President of Hoilman Construction Company, Inc.; the Bidder that has submitted the attached Bid;

2. He/~~She~~ is fully informed respecting the preparation and contents of the attached Bid and of all pertinent circumstances respecting such Bid;

3. Such Bid is genuine and is not a collusive or sham Bid;

4. Neither the said Bidder nor any of its officers, partners, owners, agents, representatives, employees or parties in interest, including this affiant, has in any way colluded, conspired, connived, or agreed, directly or indirectly with any other Bidder, firm or person to submit a collusive or sham Bid in connection with the Contract for which the attached Bid has been submitted or to refrain from bidding in connection with such Contract, or has in any manner, directly or indirectly, sought by agreement or collusion or communication or conference with any other bidder, firm or person to fix the price or prices in the attached Bid or of any other bidder, or to secure through any other bidder, or to fix any overhead, profit or cost element of the bid price or the bid price of any other bidder, or to secure through any collusion, conspiracy, connivance or unlawful agreement any advantage against Washington County, TN or any person interested in the proposed contract; and

5. The price or prices quoted in the attached Bid are fair and proper and are not tainted by a collusion, conspiracy, connivance, or unlawful agreement on the part of the Bidder or any of its agents, representatives, owners, employees, or parties in interest, including this affiant.

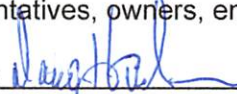
(signed) 
Doug Hoilman, President

(title)

Subscribed and sworn to before me this 1st day of February, 2024, ~~2023~~

(signature)

My commission expires 12/20/2027

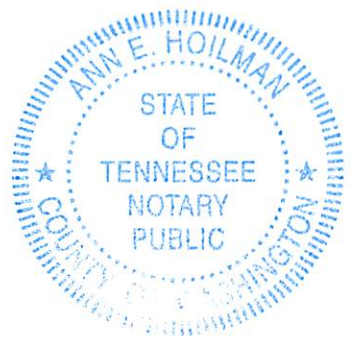

DOCUMENT 00 41 13.03 AFFIDAVIT OF COMPLIANCE WITH TENNESSEE CRIMINAL HISTORY RECORDS CHECK

TENNESSEE CODE ANNOTATED, SECTION 49-5-413

(To be submitted with bid by contractor)

I, Doug Hoilman, president or other principal

Officer of Hoilman Construction Company, Inc., swear or affirm that the
Name of Company

Company is in compliance with Public Chapter 587 of 2007, codified at Tennessee Code Annotated 49-5-413, in effect at the time of this bid submission at least to the extent required of governmental entities. I further swear or affirm that the company is in compliance with Tennessee Code Annotated, § 49-5-413.



President or Principal Officer
Doug Hoilman, President
For: Hoilman Construction Company, Inc.
Name of Company

STATE OF TENNESSEE}
COUNTY OF Washington

Subscribed and sworn before me by Doug Hoilman,

President or Principal Officer of Hoilman Construction Company, Inc.,

On this 1st day of February 2024.



Notary Public

My Commission expires: 12/20/2027

END OF DOCUMENT

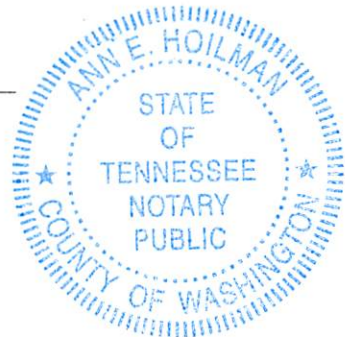



AIA Document A310™ – 2010

Bid Bond

CONTRACTOR:

Name, legal status and address

**Hoilman Construction Company, Inc.
513 Twin Oaks Dr.
Johnson City, TN 37601**

SURETY:

(Name, legal status and principal place of business)

**Travelers Casualty and Surety Company of America
One Tower Square
Hartford, CT 06183**

This document has important legal consequences. Consultation with an attorney is encouraged with respect to its completion or modification.

OWNER:

(Name, legal status and address)

**Washington County Department Of Education
405 West College Street
Jonesborough, TN 37659**

Any singular reference to Contractor, Surety, Owner or other party shall be considered plural where applicable.

BOND AMOUNT: Five Percent of the Amount Bid (5%)

PROJECT:

(Name, location or address, and Project number, if any)

LGA#22052 Security Upgrades for Sulphur Springs Elementary School

The Contractor and Surety are bound to the Owner in the amount set forth above, for the payment of which the Contractor and Surety bind themselves, their heirs, executors, administrators, successors and assigns, jointly and severally, as provided herein. The conditions of this Bond are such that if the Owner accepts the bid of the Contractor within the time specified in the bid documents, or within such time period as may be agreed to by the Owner and Contractor, and the Contractor either (1) enters into a contract with the Owner in accordance with the terms of such bid, and gives such bond or bonds as may be specified in the bidding or Contract Documents, with a surety admitted in the jurisdiction of the Project and otherwise acceptable to the Owner, for the faithful performance of such Contract and for the prompt payment of labor and material furnished in the prosecution thereof; or (2) pays to the Owner the difference, not to exceed the amount of this Bond, between the amount specified in said bid and such larger amount for which the Owner may in good faith contract with another party to perform the work covered by said bid, then this obligation shall be null and void, otherwise to remain in full force and effect. The Surety hereby waives any notice of an agreement between the Owner and Contractor to extend the time in which the Owner may accept the bid. Waiver of notice by the Surety shall not apply to any extension exceeding sixty (60) days in the aggregate beyond the time for acceptance of bids specified in the bid documents, and the Owner and Contractor shall obtain the Surety's consent for an extension beyond sixty (60) days.

If this Bond is issued in connection with a subcontractor's bid to a Contractor, the term Contractor in this Bond shall be deemed to be Subcontractor and the term Owner shall be deemed to be Contractor.

When this Bond has been furnished to comply with a statutory or other legal requirement in the location of the Project, any provision in this Bond conflicting with said statutory or legal requirement shall be deemed deleted herefrom and provisions conforming to such statutory or other legal requirement shall be deemed incorporated herein. When so furnished, the intent is that this Bond shall be construed as a statutory bond and not as a common law bond.

Signed and sealed this 1st day of February, 2024.

(Witness)

(Witness)

Hoilman Construction Company, Inc.

(Principal)

(Seal)

(Title)

Travelers Casualty and Surety Company of America
(Surety)

(Seal)

(Title) **Lavonne Sherrod, Attorney-in-Fact**

CAUTION: You should sign an original AIA Contract Document, on which this text appears in RED. An original assures that changes will not be obscured

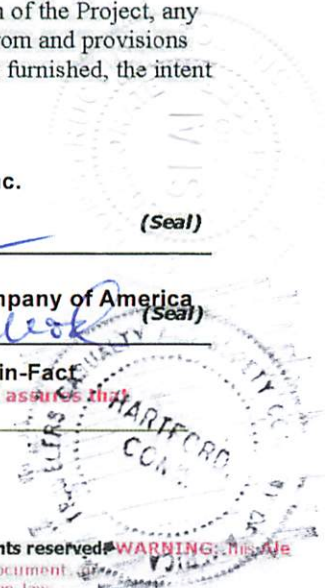



**Travelers Casualty and Surety Company of America
Travelers Casualty and Surety Company
St. Paul Fire and Marine Insurance Company**

POWER OF ATTORNEY

KNOW ALL MEN BY THESE PRESENTS: That Travelers Casualty and Surety Company of America, Travelers Casualty and Surety Company, and St. Paul Fire and Marine Insurance Company are corporations duly organized under the laws of the State of Connecticut (herein collectively called the "Companies"), and that the Companies do hereby make, constitute and appoint **Lavonne Sherrod** of **KNOXVILLE**, Tennessee, their true and lawful Attorney(s)-in-Fact to sign, execute, seal and acknowledge any and all bonds, recognizances, conditional undertakings and other writings obligatory in the nature thereof on behalf of the Companies in their business of guaranteeing the fidelity of persons, guaranteeing the performance of contracts and executing or guaranteeing bonds and undertakings required or permitted in any actions or proceedings allowed by law.

IN WITNESS WHEREOF, the Companies have caused this instrument to be signed, and their corporate seals to be hereto affixed, this **21st** day of **April**, 2021.



State of Connecticut

City of Hartford ss.

By:
Robert L. Raney, Senior Vice President

On this the **21st** day of **April**, 2021, before me personally appeared **Robert L. Raney**, who acknowledged himself to be the Senior Vice President of each of the Companies, and that he, as such, being authorized so to do, executed the foregoing instrument for the purposes therein contained by signing on behalf of said Companies by himself as a duly authorized officer.

IN WITNESS WHEREOF, I hereunto set my hand and official seal.

My Commission expires the **30th** day of **June**, 2026



Anna P. Nowik, Notary Public

This Power of Attorney is granted under and by the authority of the following resolutions adopted by the Boards of Directors of each of the Companies, which resolutions are now in full force and effect, reading as follows:

RESOLVED, that the Chairman, the President, any Vice Chairman, any Executive Vice President, any Senior Vice President, any Vice President, any Second Vice President, the Treasurer, any Assistant Treasurer, the Corporate Secretary or any Assistant Secretary may appoint Attorneys-in-Fact and Agents to act for and on behalf of the Company and may give such appointee such authority as his or her certificate of authority may prescribe to sign with the Company's name and seal with the Company's seal bonds, recognizances, contracts of indemnity, and other writings obligatory in the nature of a bond, recognizance, or conditional undertaking, and any of said officers or the Board of Directors at any time may remove any such appointee and revoke the power given him or her; and it is

FURTHER RESOLVED, that the Chairman, the President, any Vice Chairman, any Executive Vice President, any Senior Vice President or any Vice President may delegate all or any part of the foregoing authority to one or more officers or employees of this Company, provided that each such delegation is in writing and a copy thereof is filed in the office of the Secretary; and it is

FURTHER RESOLVED, that any bond, recognizance, contract of indemnity, or writing obligatory in the nature of a bond, recognizance, or conditional undertaking shall be valid and binding upon the Company when (a) signed by the President, any Vice Chairman, any Executive Vice President, any Senior Vice President or any Vice President, any Second Vice President, the Treasurer, any Assistant Treasurer, the Corporate Secretary or any Assistant Secretary and duly attested and sealed with the Company's seal by a Secretary or Assistant Secretary; or (b) duly executed (under seal, if required) by one or more Attorneys-in-Fact and Agents pursuant to the power prescribed in his or her certificate or their certificates of authority or by one or more Company officers pursuant to a written delegation of authority; and it is

FURTHER RESOLVED, that the signature of each of the following officers: President, any Executive Vice President, any Senior Vice President, any Vice President, any Assistant Vice President, any Secretary, any Assistant Secretary, and the seal of the Company may be affixed by facsimile to any Power of Attorney or to any certificate relating thereto appointing Resident Vice Presidents, Resident Assistant Secretaries or Attorneys-in-Fact for purposes only of executing and attesting bonds and undertakings and other writings obligatory in the nature thereof, and any such Power of Attorney or certificate bearing such facsimile signature or facsimile seal shall be valid and binding upon the Company and any such power so executed and certified by such facsimile signature and facsimile seal shall be valid and binding on the Company in the future with respect to any bond or understanding to which it is attached.

I, **Kevin E. Hughes**, the undersigned, Assistant Secretary of each of the Companies, do hereby certify that the above and foregoing is a true and correct copy of the Power of Attorney executed by said Companies, which remains in full force and effect.

Dated this 1st day of February, 2024



Kevin E. Hughes, Assistant Secretary

**To verify the authenticity of this Power of Attorney, please call us at 1-800-421-3880.
Please refer to the above-named Attorney(s)-in-Fact and the details of the bond to which this Power of Attorney is attached.**

Outdated Wall art



Outdated wall art



Outdated wall art



Outdated wall art



Updated wall art

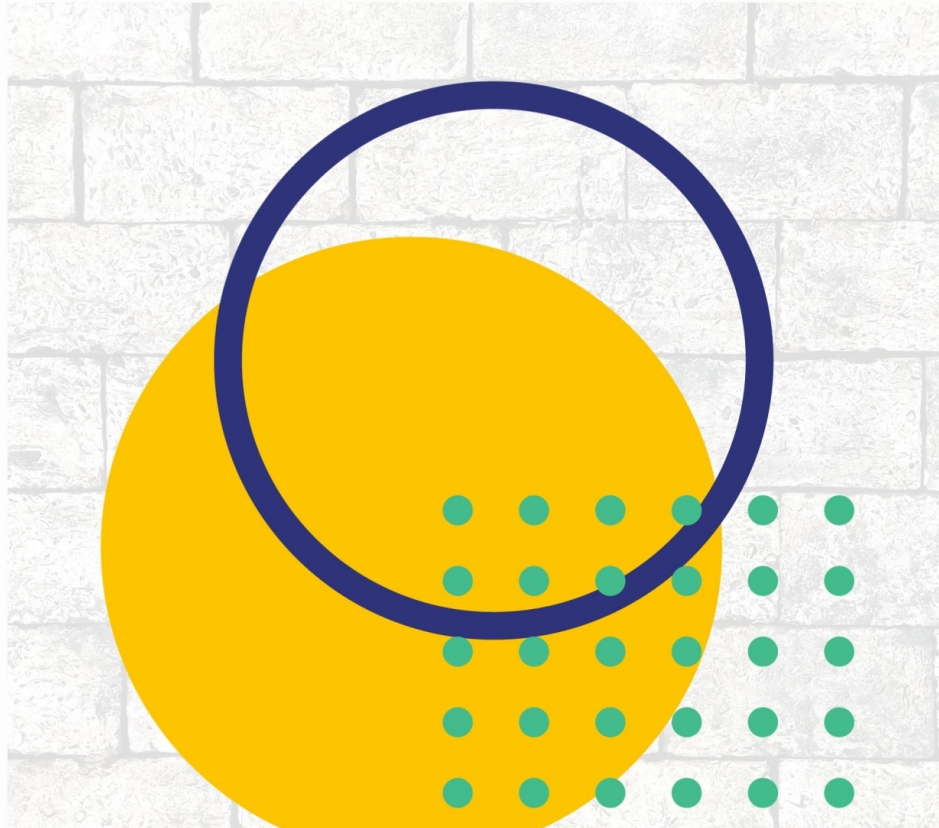

Updated wa

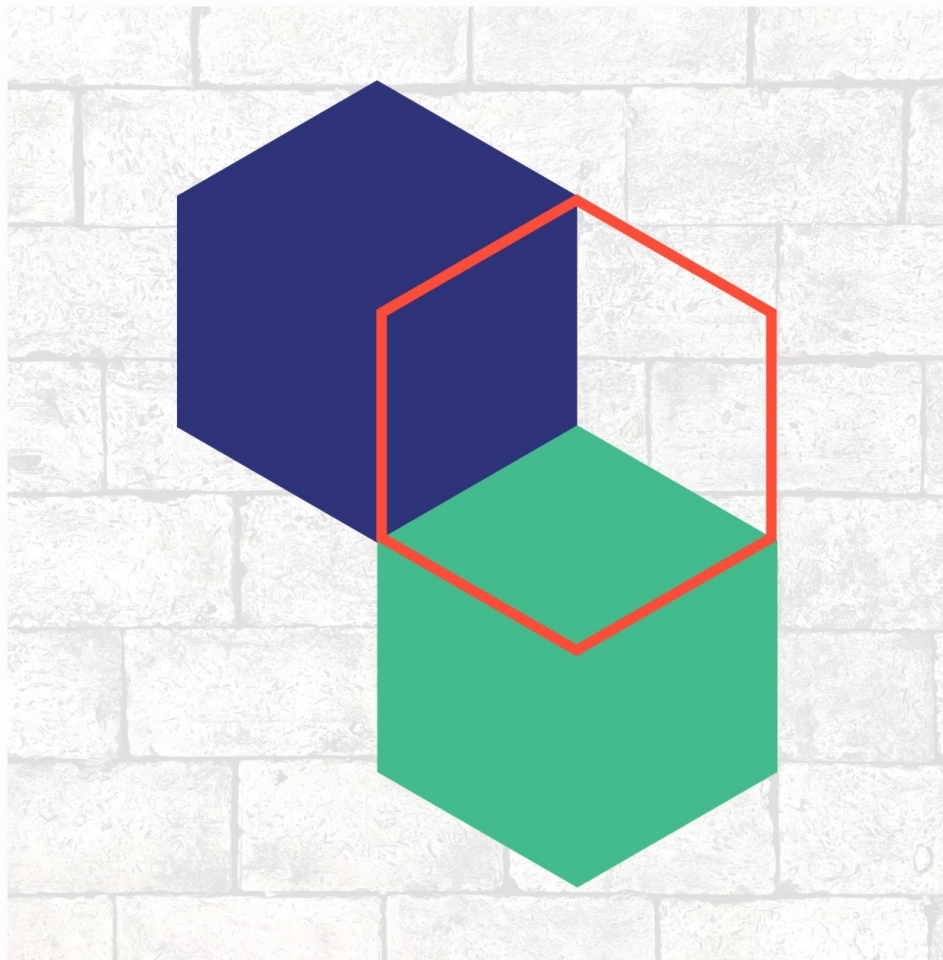

Updated wall art



Updated wall art



Updated wall art

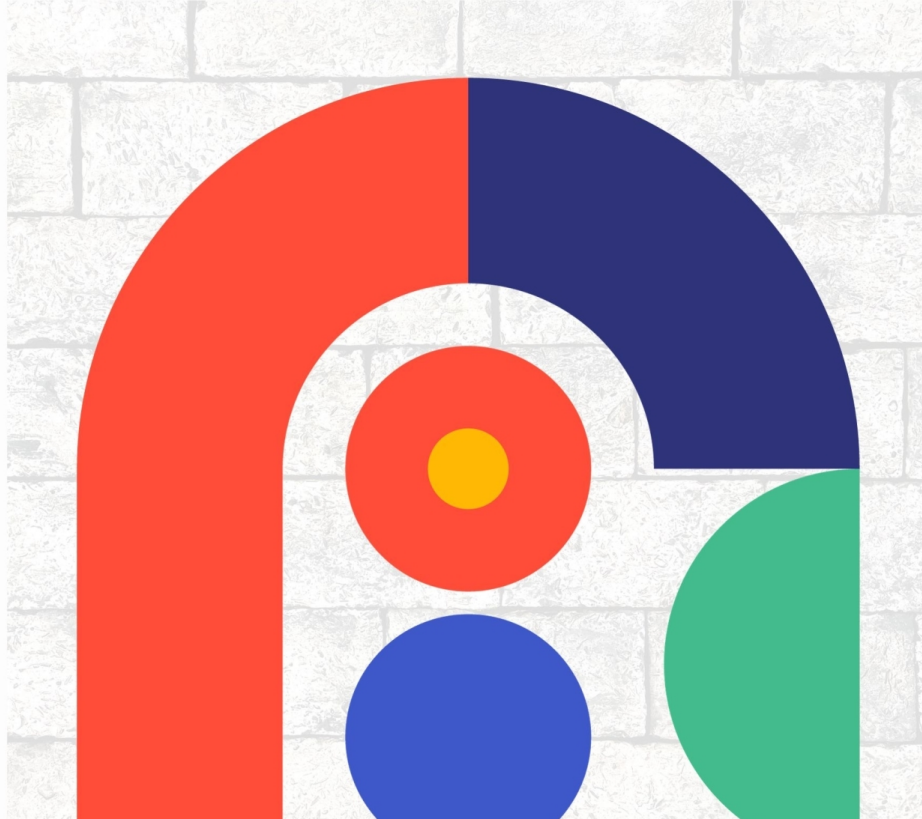

Updated wall art

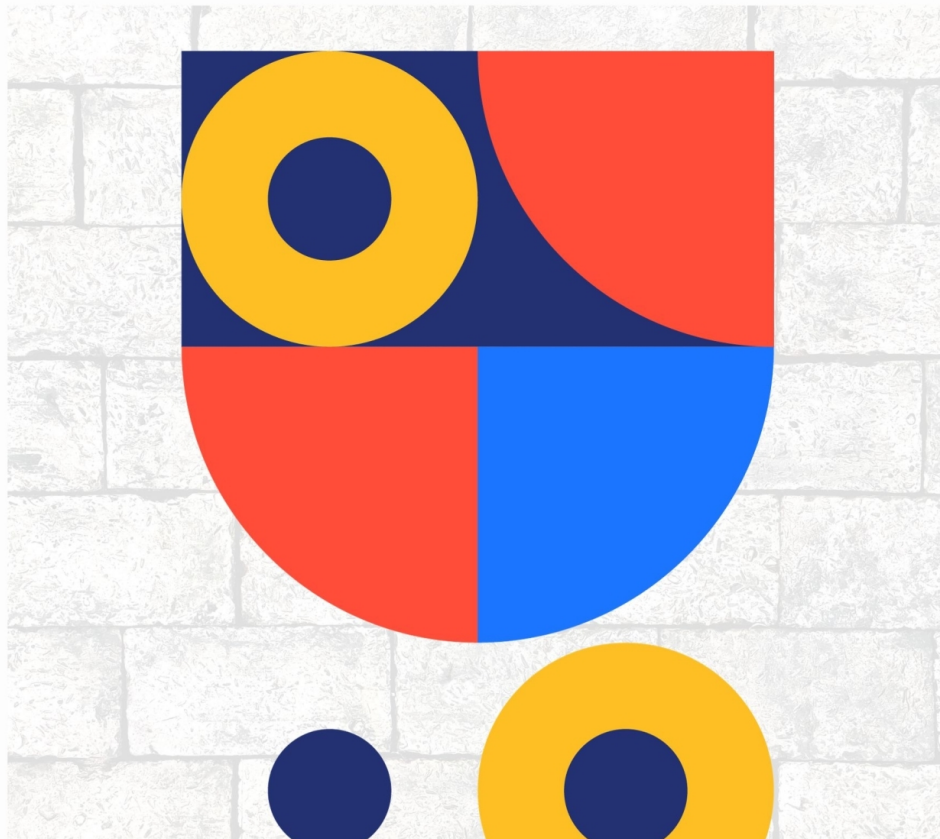

Updated wall art

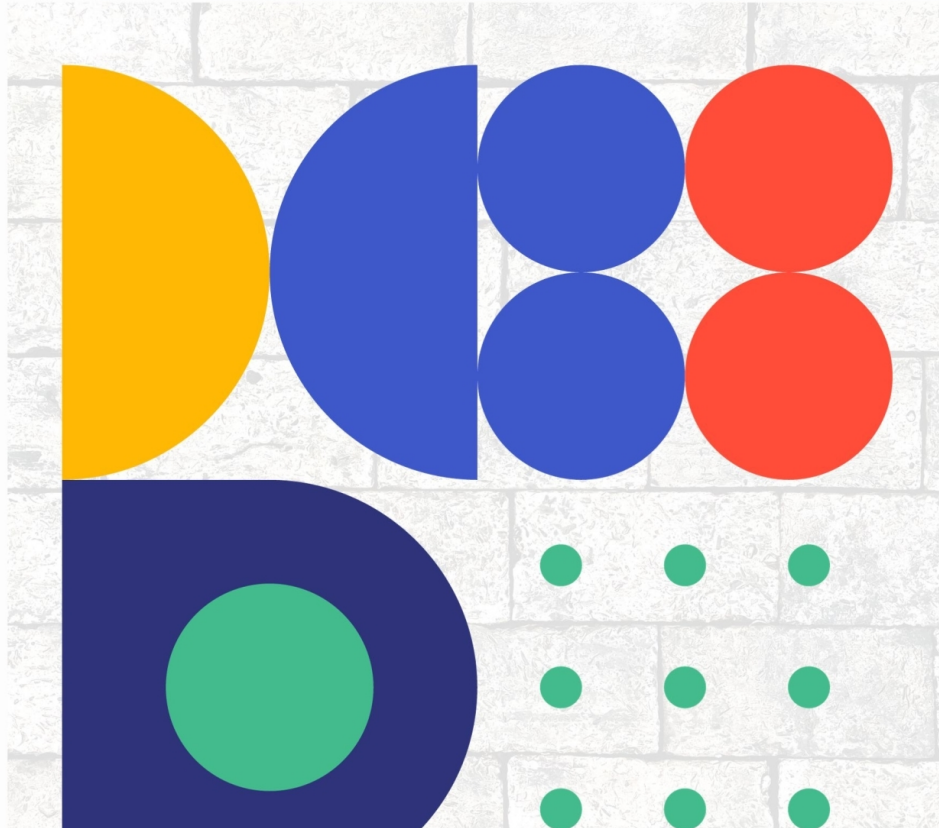

Fall Branch Auditorium

PRICE INQUIRY FORM Washington County Schools

Vendor	Description of item for price comparison	Price Quoted
Firm ES Dockery Address 254 Christian Church Rd. Gray-TN Person Contacted Jeremy Date Feb 1, 2024	LVT- FB Auditorium Remove Carpet - Install LVT & Base.	\$26,675.00
Firm Southeast Direct Flooring Address 206 Headtown Rd Jonesborough, TN Person Contacted Drew Date 2-16-24	LVT- FB Auditorium Remove Carpet - Install LVT & Base.	\$14,875.50
Firm Abbey Dockery Floorcovering Address 354 W. Market St. JC, TN. 37604 Person Contacted Steve Shoun Date 2-13-24	LVT- FB Auditorium Remove Carpet - Install LVT & Base. 20 mil LVT	\$14,150.00

Michelle Stallard

Name of person obtaining inquiry



PROPOSAL

- Blinds
- Carpet
- Resilient Flooring
- Acoustical Ceilings
- Ceramic Tile

254 Christian Church Road • Gray, Tennessee • 37615
 Voice 423-854-9191 • Fax 423-854-9022 • www.esdockery.com

January 31, 2024

<u>Washington Co Schools</u>	Project <u>Fall Branch Auditorium and Classroom</u>
<u>Mrs. Michelle Stallard</u>	Location <u>Fall Branch, TN</u>
_____	Architect _____
_____	Address _____

We propose to furnish and install, in accordance with drawings and specifications, and conditions below, and as specifically designated herein:

This proposal is based on the following conditions:

LVP Tile and Rubber Base in the Auditorium:	\$ 26,675.00
LVP Tile and Rubber Base in the Classroom:	\$ 8,8265.00

- Includes removal and disposal of existing carpeting
- Includes Luon wood subflooring in the classroom
- Includes substrate preparation limited to the repair of small isolated imperfections and a skim coat of Ardex SDF Featherfinish.

*The above price does not include any of the following:

- Any work of any type at any location not shown above
- Substrate Preparation other than that listed above
- Moisture / PH Testing or Mitigation – should either be required
- Initial Maintenance (wax and polish)
- Initial protection (poly sheeting, building paper, etc...)

NOTE: We cannot guarantee the that installers performing the above work will have had COVID 19 Immunization shots.

***() Addenda Received**

***Add 1.25% for Payment and Performance Bond**

This proposal is subject to acceptance within 30 days from date and is void thereafter at the option of the undersigned.

Accepted by _____

By _____
 Date _____

Accepted by _____

By 

Jeremy Dockery– Director of Operations
 jeremy@esdockery.com

Southeast Direct Flooring
 206 Headtown Rd
 Jonesborough, TN 37659
 (423)676-5510
 seflooringdirect@gmail.com



*Event room
 @ Fall Branch*

Estimate

ADDRESS
 Washington CSS

ESTIMATE # 1282
DATE 02/16/2024

ACTIVITY	QTY	RATE	AMOUNT
Sales event room @ fallbranch Shaw branded Luxury vinyl plank terrain 2 30 mil commercial handling and shipping is included in price \$2.99 per sqft	2,250	2.99	6,727.50
Sales shaw ca179 lokworx adhesive 100 sqft coverage per 4 gallon pale \$140 per pale	6	140.00	840.00
Sales installation lvp	2,250	2.25	5,062.50
Sales tearout disposal floor prep	2,250	0.75	1,687.50
Sales cove base 120 ft per roll	2	150.00	300.00
Sales installation cove base molding \$1.5 per linear foot	148	1.50	222.00
Sales glue cartridge cove base	3	12.00	36.00

Please review and inform me of approval through email:
 seflooringdirect@gmail.com
 phone: 423-676-5510
 payment of 50% is required before materials are ordered.
 Thanks! Drew

TOTAL **\$14,875.50**

Accepted By

Accepted Date

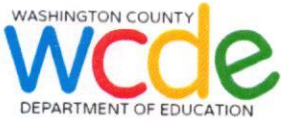

Michelle Stallard <stallardm@wcde.org>

Fw: Luxury Vinyl Plank Flooring for DBHS & Fall Branch Elementary

1 message

STEVE SHOUN <steve.shoun.floors@outlook.com>
To: Michelle Stallard <stallardm@wcde.org>

Tue, Feb 20, 2024 at 10:20 AM

From: STEVE SHOUN
Sent: Tuesday, February 13, 2024 12:14 PM
To: StallardM@WCDE.org <StallardM@WCDE.org>
Subject: Luxury Vinyl Plank Flooring for DBHS & Fall Branch Elementary

Michelle,

The following price includes a 20 mil wear surface Luxury Vinyl Plank floorcovering, removing the existing carpet and disposal, also included is 4" vinyl Base and installation of the flooring and base.

DANIEL BOONE HIGH SCHOOL:

College & Carrer Room = \$2,000.00

2 Conference rooms in Guidance Dept. = \$3,560.00

FALL BRANCH ELEMENTARY SCHOOL:

Auditorium Room = \$14,150.00

Art Room & Closet = \$5,950.00

Library = \$10,150.00

TOTAL COST = \$38,810.00

Thank You for allowing the opportunity to submit this quote to you.

Steve Shoun

Dockery Floorcovering
3546 W. Market Street
Johnson City, TN 37604

423-794-9860 mobile/voicemail

423-926-6134 office 423-926-6180 fax

Bid Tabulation

Stage Curtains

Washington County Department of Education

Bid Opening: 2:00 PM EST, Tuesday, February 20, 2024

Bidding Firm	Time Frame March 8, 2024 - June 30, 2024	Contact	Total Project Bid
Premiere Stage Supply, LLC	<input checked="" type="checkbox"/>	Greg Schick	\$51,387.00
			RV \$9,050.00
			DB \$18,118.00
			DC \$24,219.00
Kendall Stage Curtains Co.	<input checked="" type="checkbox"/>	Brenda Helmick	\$60,230.00
			RV \$11,990.00
			DB \$23,245.00
			DC \$24,219.00



TIPS/TAPS QUOTE

CONTRACT #200301

HALE MANUFACTURING
11206 COSBY MANOR ROAD
UTICA, NY 13502
Phone: (800) 873-4253
Fax: (315) 894-5046

QUOTE NO: 24024748 REV1
DATE: February 15, 2024

TO: WASHINGTON COUNTY SCHOOLS
ATTN: JIM JORDAN, TENNESSEE OFFICE SUPPLY

PHONE: (423) 677-9257
FAX:

SERIES	SPECIES AVAILABLE	OPTIONS	JOB NAME	SHIP TO	LEAD TIME
SARATOGA	RED OAK, MAPLE	FINISH, WORK SURFACES AS WOOD OR LAMINATE, DOOR & DRAWER PULLS	LAMAR ELEMENTARY SCHOOL	ZONE 3 (TN)	10-12 WEEKS

REF	QTY	ITEM #	DESCRIPTION	LIST EA. Delivered	LIST EXT. Delivered
DESK 1 & 2	2	CD7229L	FULL TOP DESK, 29"H x 72"W x 28"D, TWO GROMMETS IN WORK SURFACE, J-CHANNEL CABLE MANAGEMENT	\$4,560.00	\$9,120.00
DESK 1 & 2	2	CDBBF	BBF PEDESTAL, 25"H x 17"W x 23"D, TWO BOX DRAWERS, ONE FILE DRAWER, ALL WITH LOCKS	\$2,621.00	\$5,242.00
CORNERS	2	CD39-90OC	OPEN 90 DEGREE CORNER UNIT, 39"H x 28"W x 28"D, TWO ADJUSTABLE WOOD SHELVES	\$3,364.00	\$6,728.00
BOOK DROP	1	CD3639LBR	BOOK RETURN MODULE, 39"H x 36"W x 28"D	\$4,514.00	\$4,514.00
BOOK DROP	1	CD3230BC	DEPRESSIBLE BOOK CART, 31"H x 24"W x 25"D	\$4,969.00	\$4,969.00
STORAGE CABINET	1	CUB3639H/W	CUPBOARD UNIT, 39"H x 36"W x 28"D, TWO HINGED WOOD DOORS, TWO ADJUSTABLE WOOD SHELVES	\$5,843.00	\$5,843.00

Total List, Delivered:	\$36,416.00
LESS TIPS/TAPS Contract Discount, 44% (Delivered):	\$16,023.04
Sub-Total Net, Delivered:	\$20,392.96
PLUS Dealer Installation:	\$2,039.30
TOTAL NET DELIVERED TO MEMBER:	\$22,432.26

NOTES:

- ALL PRICES ARE VALID FOR THIRTY (30) DAYS FROM THE QUOTATION DATE.
- PRICED ON TIPS/TAPS CONTRACT #200301.
- TIPS MEMBERS MUST EMAIL ALL PURCHASE ORDERS TO tipspo@tips-usa.com. THE TIPS OFFICE WILL VALIDATE THE ORDERS AND FORWARD THEM ONTO HALE FOR PROCESSING.
- AVAILABLE IN RED OAK OR MAPLE WOOD SPECIES WITH STANDARD CORRESPONDING HALE FINISHES OR PAINT COLORS.
- WORK SURFACES AVAILABLE AS WOOD OR LAMINATE. WE HAVE MATCHING WOOD GRAIN LAMINATES TO OUR STANDARD FINISHES, OR YOU MAY SPECIFY YOUR OWN LAMINATE COLOR.
- SPECIFY DOOR & DRAWER PULLS WHEN ORDERING.
- FREIGHT IS DOCK TO DOCK DELIVERY TO ZONE 3 (TN).
- DRAWING APPROVAL MAY BE REQUIRED PRIOR TO PRODUCTION.
- LAYOUT AND FIELD MEASUREMENTS MAY BE REQUIRED PRIOR TO PRODUCTION.
- LEAD TIME IS APPROXIMATELY 10-12 WKS AFTER A "CLEAN" ORDER IS RECEIVED. A CLEAN ORDER IS DEFINED AS ALL DETAILS REQUIRED TO MANUFACTURE YOUR ORDER ARE FINALIZED. (EX: FIELD MEASUREMENTS, DRAWING APPROVAL, FINISH, TOP EDGE PROFILE, DOOR PULL, ETC). PURCHASE ORDERS ARE NOT RELEASED INTO PRODUCTION UNTIL ALL INFORMATION IS PROVIDED TO US. TO AVOID A DELAY IN YOUR ORDER BEING PROCESSED, PLEASE BE SURE TO ORDER CORRECTLY AND SUPPLY ALL INFORMATION REQUIRED.
- QUOTED USING INFORMATION PROVIDED BY THE CUSTOMER. ANY CHANGES WILL REQUIRE A REVISED QUOTATION.

Quotation prepared by: **TYLOR SCHMID**

THANK YOU FOR YOUR BUSINESS!

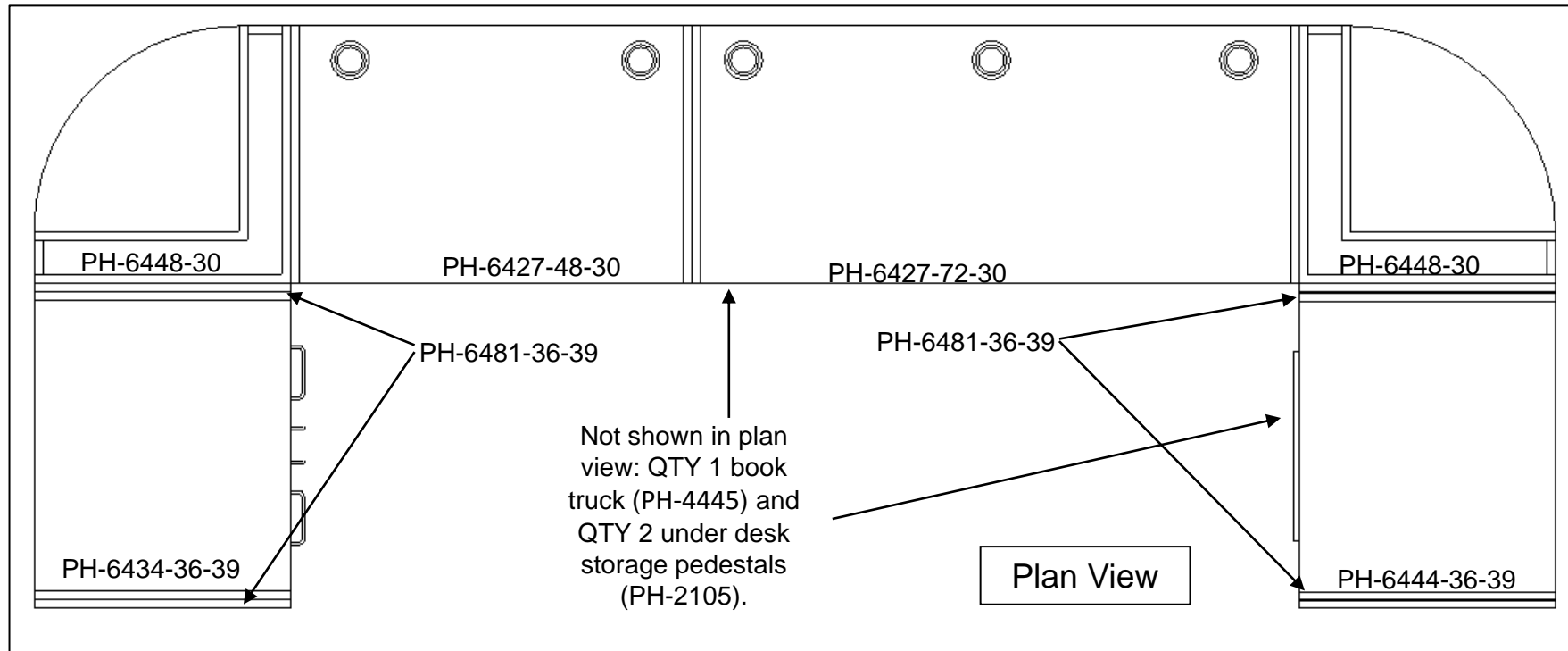
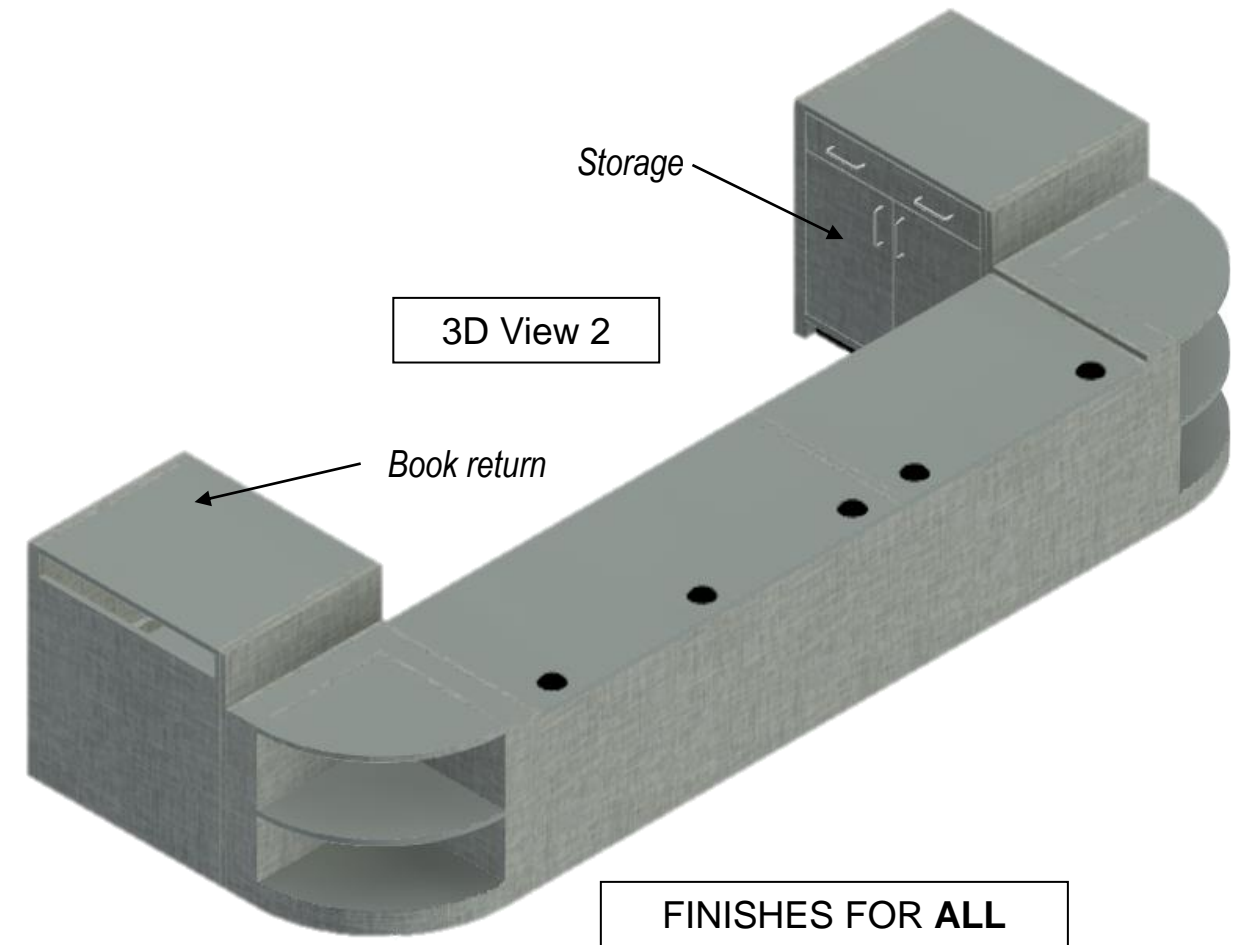
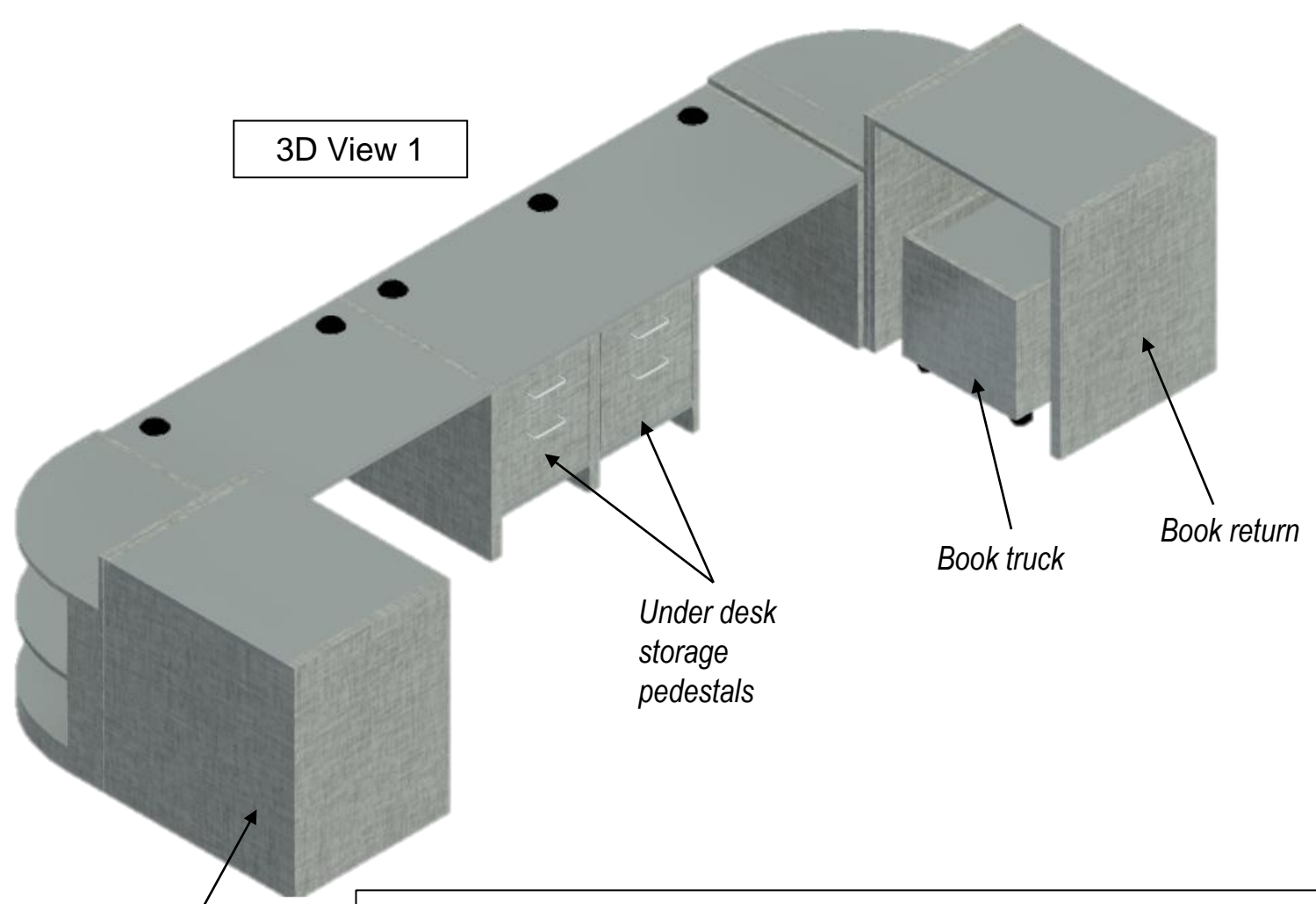

FINISHES FOR ALL FURNITURE:
 Laminate top: North Sea
 Laminate Sides/Back/Doors: Handspun Slate
 Laminate Shelves (Corners): North Sea



LAMINATE #1
 WA Handspun Slate
 5035-38



LAMINATE #2
 WA North Sea
 D90-60

NOTE: Circulation desk is not ADA compliant. School is responsible to indicate if additional ADA spots are required.





725 West Walnut Street
 Johnson City, TN 37604
 PH: 423-282-5400
 www.inspirebusinessinteriors.com

Date Printed: 11/21/2023
 Valid for 30 Days
 Sales Name: Tracy Johnson
 Sales Phone:

SOLD TO:

Washington County Schools
 405 W. College St.
 Jonesborough, TN 37659

SHIP TO:

Washington County Schools
 405 W. College St.
 Jonesborough, TN 37659

Sales Number:

PROPOSAL

Lamar Elementary School- Circulation Desk Per Sourcewell #94372

LINE	IMAGE	QTY	PRODUCT	UNIT SELL	EXT SELL
------	-------	-----	---------	-----------	----------

1		2	CUSTOM-PH-6448-30-L	\$1,875.30	\$3,750.60
			Desk-Corner- Open 90-30"H x 30" D- Laminate HPL		
			.F, .T		
				LAMINATE SIDES- WILSONART HANDSPUN SLA	
				LAMINATE TOPS- WILSONART NORTH SEA	

LINE	IMAGE	QTY	PRODUCT	UNIT SELL	EXT SELL
------	-------	-----	---------	-----------	----------

2		1	PH-6434-36-39-L	\$4,161.50	\$4,161.50
			DESK- SINGLE DRAWER/ DOOR STORAGE- 39"H X 36"W X 30"D- LAMINATE HPL		
			.WA, .WA		
				LAMINATE SIDES- WILSONART HANDSPUN SLA	
				LAMINATE TOP- WILSONART NORTH SEA	

LINE	IMAGE	QTY	PRODUCT	UNIT SELL	EXT SELL
------	-------	-----	---------	-----------	----------

3		1	PH-6444-36-39-L	\$2,130.10	\$2,130.10
			Desk-Book Return- 39"H x 36" W x 30"D- Laminate HPL		
			,		
				LAMINATE SIDES- WILSONART HANDSPUN SLA	
				LAMINATE TOPS- WILSONART NORTH SEA	

LINE	IMAGE	QTY	PRODUCT	UNIT SELL	EXT SELL
4		1	PH-6427-48-39-L	\$2,139.20	\$2,139.20
			Desk-30"H x 48"Wx 30"D- Laminate HPL		
			,		
				LAMINATE SIDES- WILSONART HANDSPUN SLA	LAMINATE TOPS- WILSONART NORTH SEA

LINE	IMAGE	QTY	PRODUCT	UNIT SELL	EXT SELL
5		1	PH-6427-72-30-L	\$3,045.00	\$3,045.00
			Desk- 29" Hx 72" W x 30"D- Laminate HPL		
			,		
				LAMINATE SIDES- WILSONART HANDSPUN SLA	LAMIANTE TOPS-WILSONART NORTH SEA

LINE	IMAGE	QTY	PRODUCT	UNIT SELL	EXT SELL
6		2	PH-6481-36-39-L	\$445.90	\$891.80
			Applied End- 39" H x 30"D-Laminate HPL		
			,		
				LAMINATE SIDES- WILSONART HANDSPUN SLA	LAMINATE TOPS- WILSONART NORTH SEA

LINE	IMAGE	QTY	PRODUCT	UNIT SELL	EXT SELL
7		2	PH-2105-L	\$1,488.90	\$2,977.80
			File Drawer Pedestal- 28"H x 16"W x 20"D Laminate HPL		
			,		
				LAMINATE SIDES- WILSONART HANDSPUN SLA	LAMINATE TOPS- WILSONART NORTH SEA

LINE	IMAGE	QTY	PRODUCT	UNIT SELL	EXT SELL
8		1	PH-4445-L	\$3,572.80	\$3,572.80
			Depressible Book Truck-27"H x 27"W x 22"D Laminate HPL		
			,		
				LAMINATE SIDES- WILSONART HANDSPUN SLA	LAMINATE TOPS- WILSONART NORTH SEA

LINE	IMAGE	QTY	PRODUCT	UNIT SELL	EXT SELL
9		1	FREIGHT	\$0.00	\$0.00
			Shipment to 37604		

LINE	IMAGE	QTY	PRODUCT	UNIT SELL	EXT SELL
10		1	DELIVERY & INSTALLATION	\$2,200.00	\$2,200.00
			Delivery to LES		

Notes:

Signature: _____ Date: _____ PO #: _____

Approved By: _____ Title: _____

TERMS & CONDITIONS

Notes:

Pricing does not include sales tax. Freight, if any, will be added at the time of invoice. A signature is needed to proceed with order. Payment terms: 50% deposit upon order. Net 20 upon final invoice.

Terms:

Client agrees that the list of items herein has been reviewed and accurately sets forth the items to be purchased. The client acknowledges and agrees that the items to be purchased are made to order and may not be returned and that the purchase of the items is final. The client agrees to pay the purchase price according to net 20 days payment terms.

Any unpaid balance shall accrue interest of 1 1/2% per month. Buyer agrees to pay the balance, as extended, together with all cost of collection, including reasonable attorney's fees and court costs if collection by law or by an attorney at law is necessary.



PRESTON

WOODWORKING

720 Rolling Hills Drive, Johnson City, TN 37604 Phone (423) 928-9331 Fax (423) 928-3958

Date: February 6, 2024
To: Inspire Business Interiors
Attn: Isabelle Tisor
From: Greg Smith
Re: Gray Elementary School
Includes: Quote

Classrooms – 4 Total
Plastic Laminate Cabinets and Countertops
(Layout based on provided drawing and pictures)
Installation

\$ 12,176

Note:

- Please call with any questions.
- Shop drawings to be provided with approved quote.
- Demolition of existing casework is not included in quote.
- Sinks to be provided by others.



725 West Walnut Street
 Johnson City, TN 37604
 PH: 423-282-5400
 www.inspirebusinessinteriors.com

Date Printed: 2/2/2024
 Valid through January 20 2024
 Sales Name: Tracy Johnson
 Sales Phone:

SOLD TO:

Washington County Schools
 405 W. College St.
 Jonesborough, TN 37659

SHIP TO:

Washington County Schools
 405 W. College St.
 Jonesborough, TN 37659

Sales Number:

PROPOSAL

Washington Co. Schools- Gray Elementary Cubby Storage OMNIA R191804

LINE	IMAGE	QTY	PRODUCT	UNIT SELL	EXT SELL
1		12	HESC3H3WS 3-HIGH 3-WIDE CUBBY Select Caster, Door Selection, End Panel, Door/Case Paint Grade Options, Select Grade 1 Paint, Select Frame Paint Color, End Panel Paint Grade Options, Select Grade 1 Paint, Laminate Grade Options, Select Grade 1 Laminate Finish	\$1,211.40	\$14,536.80
			Standard Without Door Solid P1 Paint Opts Loft Match Case P1 Paint Opts Black Grd L1 Standard Laminate Field Elm		
2		1	DELIVERY & INSTALLATION Install @ Gray Elementary	\$529.41	\$529.41

Notes:

Signature: _____ Date: _____ PO #: _____

Approved By: _____ Title: _____

TERMS & CONDITIONS

Notes:

Pricing does not include sales tax. Freight, if any, will be added at the time of invoice. A signature is needed to proceed with order. Payment terms: 50% deposit upon order. Net 20 upon final invoice.

Terms:

Client agrees that the list of items herein has been reviewed and accurately sets forth the items to be purchased. The client acknowledges and agrees that the items to be purchased are made to order and may not be returned and that the purchase of the items is final. The client agrees to pay the purchase price according to net 20 days payment terms. Any unpaid balance shall accrue interest of 1 1/2% per month. Buyer agrees to pay the balance, as extended, together with all cost of collection, including reasonable attorney's fees and court costs if collection by law or by an attorney at law is necessary.

THIS CONTRACT made and entered into on this the 10th day of August, 1989, by and between the STATE UNIVERSITY AND COMMUNITY COLLEGE SYSTEM OF TENNESSEE by the TENNESSEE BOARD OF REGENTS and EAST TENNESSEE STATE UNIVERSITY, hereinafter known and referred to as the "University System"; and WASHINGTON COUNTY BOARD OF EDUCATION, hereinafter referred to as "County Board";

W I T N E S S E T H:

WHEREAS, since 1981, a campus school has been operated on the campus of ETSU, pursuant to an agreement entered into by the State University and Community College System of Tennessee, East Tennessee State University, and the Washington County Board of Education; and

WHEREAS, certain provisions of said contract have come into question and certain factual circumstances have arisen in the operation of said University School to require complete review of the relationship between the parties in the operation of said University School; and

WHEREAS, the future successful operation of the University School depends on a cooperative relationship between the Washington County Board of Education and the State University and Community College System of Tennessee, East Tennessee State University, the parties recognize and acknowledge those mutual responsibilities and pledge the future operation of the school pursuant to the terms and statutes and the terms and provisions of this contract; and

WHEREAS, by reason of the foregoing, the parties have determined that it is in the general best interests of all parties hereto and the personnel and students at said University School, that the entire matter of operation of said school be reviewed and that the former contract be cancelled and a new contract be entered into between the parties.

NOW, THEREFORE, for and in consideration of the mutual covenants and agreements hereinafter set forth and described, and the benefits that are to be derived by each of the parties hereto, all of which are deemed to be sufficient for the purposes of furnishing consideration for this contract, and pursuant to the laws and statutes of the State of Tennessee, the parties hereto have mutually agreed and bound themselves as follows:

1. The term of this contract shall begin on the 1st day of

PREPARED BY:

HICKS, ARNOLD, HAYNES

& SANDERS

ATTORNEYS AT LAW

JOHNSON CITY 37601

ONESBOROUGH, TENN. 37859

July, 1989, and shall continue indefinitely until cancelled according to the terms and provisions hereof. Either party may cancel this contract by giving two (2) year's written notice in advance of the annual renewal date of July 1.

Notice of cancellation for the respective parties shall be at the following addresses:

- (1) Office of the President
East Tennessee State University
Johnson City, Tennessee 37604
- (2) Superintendent of Washington County Schools
Central Office
405 College Street
Jonesborough, Tennessee 37659

2. The previous contract between the parties, dated and signed for the University System on February 25, 1980, for ETSU on February 15, 1980, and for the County Board on February 15, 1980 (hereinafter called the 1980 Contract) is hereby cancelled and rendered null and void and for nothing further held.

3. That pursuant to the provisions of T.C.A. Section 48-8-105(b) T.C.A., the control of said University School shall be wholly under the direction of the State University and Community System of Tennessee through the president of ETSU, including but not limited to the following specific responsibilities:

a. The furnishing of all buildings, equipment, heating, lights, water, custodial service, maintenance and repair as well as all furnishing of all personnel necessary for the operation of said school.

b. The responsibility for salaries, assignment, supervision, retention, promotion, tenure, discharge and control of all of the professional, administrative, secretarial, and support personnel of the University School shall be wholly under the direction of the State University and Community College System.

c. The responsibility for policy, curricula, and admission of students will be vested in the University System and that it will provide for the teaching of children of public school age in the said University School pursuant to the terms of Section 49-8-105(b). The County Board will cooperate in verifying all state and federal curricula requirements and any reports, applications for funds, services or certifications or actions which are required

PREPARED BY:

HICKS, ARNOLD, HAYNES

& SANDERS

ATTORNEYS AT LAW

JOHNSON CITY 37601

JONESBOROUGH, TENN. 37659

of the Washington County Board by state or federal law or policy will continue to be done by the school board. The University System will furnish the County Board all data necessary for such verification at no expense to the County Board.

4. That the University System shall be entitled to and shall receive all state and federal funds received by the county as a result of this contract for the operation of said school including per capita and pro rata share of allocations and equalization funds, state capital outlay funds, textbook funds, and enumerated other funds limited to an ADA proportional share of sales tax, property tax, interest and penalty on delinquent tax, business tax and marriage license fees, that may be allocated for the operation of all public schools in Washington County, Tennessee, but the proceeds of local bond issues and local capital outlay notes are specifically exempted from this contract.

5. The County Board will comply with all state and federal statutes relative to the receipt of special grants and fund which are conditioned upon the retention of management or control by the County Board, and in such eventuality, only to the extent as required by law, it being the intent of this contract that the total management, operation and control of said University School shall be in the University System and that the County Board shall retain no responsibility unless required by law so to do, except that the County Board will provide limited bus service, food service, and other similar specific services that have been provided in the past relationship between the parties.

Regardless of anything else herein to the contrary, the County Board acknowledges legal responsibility as the local educational agency under 20 U.S.C.A. Section 1401, et. seq. (Education for All Handicapped Childrens' Act), T.C.A. 49-10-101 etc., and this contract does not in any way alter or change those responsibilities.

6. That each party hereto will be responsible for its own actions insofar as liability to any third party is concerned, and it is further agreed that neither party will be responsible for the actions of the other in any phase of the said University School.

7. The University System acknowledges its legal responsibility for all personnel actions taken by the University to employees hired under the terms of the herein contract. That legal responsibility for personnel actions and any

PREPARED BY:

HICKS, ARNOLD, HAYNES
& SANDERS

ATTORNEYS AT LAW

JOHNSON CITY 37601

ONESBOROUGH, TENN. 37639

actions by an employee is defined and limited by the terms of T.C.A. 9-8-301 et. seq. and the individual tenure-track, administrative and secretarial contracts entered into with the employee and the University. The University agrees to include the following language in any new contracts signed subsequent to the effective date of the contract: "I hereby voluntarily and knowingly waive any tenure or tenure rights, if any, previously acquired in the Washington County School System". It is the basic premise of this contract with regard to liability in the operation of said University School that each party hereto will be responsible for its own actions and neither should be held responsible for the actions of the other.

8. This contract contains the complete agreement between the parties and nothing herein shall be construed to include any obligation, custom or practice not specifically included herein, and any amendments or modifications hereof shall be in writing and agreed upon by the parties and signed by the respective parties and attached hereto.

IN WITNESS WHEREOF, the parties hereto have hereunto set their hands by their duly authorized representatives in duplicate, either of which copy may be treated as an original for all purposes, this the day and year first above written.

STATE UNIVERSITY AND COMMUNITY
COLLEGE SYSTEM OF TENNESSEE

BY:

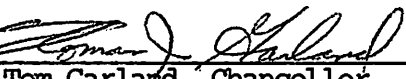

Dr. Ronald Beller, President
East Tennessee State University

BY:

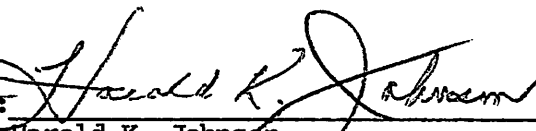

Tom Garland, Chancellor
Tennessee Board of Regents

WASHINGTON COUNTY BOARD OF EDUCATION

BY:

Harold K. Johnson
Chairman of the Board

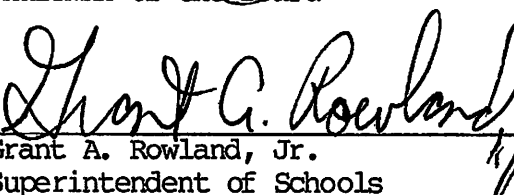
BY:

Grant A. Rowland, Jr.
Superintendent of Schools

PREPARED BY:

HICKS, ARNOLD, HAYNES

& SANDERS

ATTORNEYS AT LAW

JOHNSON CITY 37601

ONESBOROUGH, TENN. 37659

STATE OF TENNESSEE
COUNTY OF WASHINGTON

After being duly sworn, personally appeared before me, a Notary Public in and for the State and County aforesaid, Dr. Ronald Beller, with whom I am personally acquainted (or proved to me on the basis of satisfactory evidence) and who, upon oath, acknowledged himself to be the President of East Tennessee State University, the within named bargainor, and that he as such President, being authorized so to do, executed the foregoing instrument for the purposes therein contained by signing the name of STATE UNIVERSITY AND COMMUNITY COLLEGE SYSTEM OF TENNESSEE by himself as President of East Tennessee State University.

WITNESS MY HAND AND OFFICIAL SEAL at office in the State and County aforesaid, this the 16th day of August, 1989.

Janice Randolph
NOTARY PUBLIC

My Commission expires: July 2, 1992

STATE OF TENNESSEE
COUNTY OF DAVIDSON

After being duly sworn, personally appeared before me, a Notary Public in and for the State and County aforesaid, Tom Garland, with whom I am personally acquainted (or proved to me on the basis of satisfactory evidence) and who, upon oath, acknowledged himself to be the Chancellor of the Tennessee Board of Regents, the within named bargainor, and that he as such Chancellor, being authorized so to do, executed the foregoing instrument for the purposes therein contained by signing the name of STATE UNIVERSITY AND COMMUNITY COLLEGE SYSTEM OF TENNESSEE by himself as Chancellor of the Tennessee Board of Regents.

WITNESS MY HAND AND OFFICIAL SEAL at office in the State and County aforesaid, this the 17th day of August, 1989.

Anita Jones
NOTARY PUBLIC

My Commission expires: July 18, 1992

STATE OF TENNESSEE
COUNTY OF WASHINGTON

After being duly sworn, personally appeared before me, a Notary Public in and for the State and County aforesaid, Harold K. Johnson, with whom I am personally acquainted (or proved to me on the basis of satisfactory evidence) and who, upon oath, acknowledged himself to be the Chairman of WASHINGTON COUNTY BOARD OF EDUCATION, the within named bargainor, and that he as such Chairman, being authorized so to do, executed the foregoing instrument for the purposes therein contained by signing the name of Washington County Board of Education by himself as Chairman.

WITNESS MY HAND AND OFFICIAL SEAL at office in the State and County aforesaid, this the 10th day of August, 1989.

Beverly D. Thomas
NOTARY PUBLIC

My Commission expires: July 28, 1991

PREPARED BY:

HICKS, ARNOLD, HAYNES

& SANDERS

ATTORNEYS AT LAW

JOHNSON CITY 37601

ONESBOROUGH, TENN. 37659

STATE OF TENNESSEE
COUNTY OF WASHINGTON

After being duly sworn, personally appeared before me, a Notary Public in and for the State and County aforesaid, Grant A. Rowland, with whom I am personally acquainted (or proved to me on the basis of satisfactory evidence) and who, upon oath, acknowledged himself to be the Superintendent of Schools of WASHINGTON COUNTY BOARD OF EDUCATION, the within named bargainer, and that he as such Superintendent of Schools, being authorized so to do, executed the foregoing instrument for the purposes therein contained by signing the name of Washington County Board of Education by himself as Superintendent of Schools.

WITNESS MY HAND AND OFFICIAL SEAL at office in the State and County aforesaid, this the 10th day of August, 1989.

Beverly K. Thomas
NOTARY PUBLIC

My Commission expires: July 28, 1991

PREPARED BY:

HICKS, ARNOLD, HAYNES

& SANDERS

ATTORNEYS AT LAW

JOHNSON CITY 37601

ONESBOROUGH, TENN. 37639

MASTER AGREEMENT

between

EAST TENNESSEE STATE UNIVERSITY

and

_____ **BOARD OF EDUCATION**

East Tennessee State University (“ETSU”), a State of Tennessee public institution of higher education, and the _____ Board of Education (the “Board”) (collectively “Parties”) enter this Agreement, effective the _____ day of _____, 2024, relative to the funding and operation of a training school for practice teachers on ETSU’s campus (the “School”).

Recitals

Whereas, ETSU, under the direction of its Board of Trustees (“Trustees”), maintains a training school pursuant to Tenn. Code Ann. § 49-8-105, as amended effective May 11, 2023 (the “Act”), for the purpose of providing practice teaching experience for teachers in training; and

Whereas, ETSU teaches the students enrolled in the School the same course of study as prescribed by the state board of education for the public school system in grades kindergarten through twelfth grade (K—12) or the grades appropriate for the school; and,

Whereas, the Act authorizes ETSU, acting through its Trustees, to contract with a local board of education to provide for the teaching of public-school age children in the training school, whereby the training school shall receive all state and federal funds received by the local board of education because of this contract for the operation of the training school, including TISA allocations and any other funds that may be allocated for the operation of public schools of this state; and,

Whereas, the School is eligible to receive grants and other funds in the same manner as the public schools in this state; and,

Whereas, the School is wholly under the control of the president of ETSU; and,

Whereas, ETSU desires to contract with the _____ Schools Board of Education to provide the teaching of public-school-age children in the training school, whereby the training school shall receive all state and federal funds received by the local board of education because of this contract for the operation of the training school, including TISA allocations and any other funds that may be allocated for the operation of public schools of this state; and,

Whereas, the Board recognizes the benefit of contracting with ETSU to maintain a training school for the purpose of providing practice teaching experience for teachers in training; and,

Whereas, the Parties desire to codify the terms and conditions of their relationship; and whereas, the Parties intend for this Agreement to govern their relationship and thereby terminate all prior agreements between the Parties;

NOW, THEREFORE, in consideration of the mutual covenants and promises contained herein and for other good and valuable consideration, the receipt and sufficiency of which the Parties acknowledge, the Parties agree as follows:

A. Recitals Incorporated

The Parties incorporate the Recitals herein by reference and make them a part of this Agreement.

B. Legal Structure and Authority

1. ETSU operates the School under the authority of and pursuant to Tenn. Code Ann. § 49-8-105, as amended effective May 11, 2023, which authorizes ETSU to maintain a training school for grades pre-K—12 for the purpose of providing practice teaching experience for teachers in training.

2. ETSU has an Education Preparation Program with a mission of preparing highly educated teaching professionals from early childhood, elementary through secondary education and across all areas including special education, physical education, and the next generation of educational leaders and student services professionals. The School furthers the mission of ETSU by providing a research and training ground for educator candidates and other school professionals.

3. ETSU operates the School, under the direction of its Trustees and as required by law the School is under the direct control of the president of ETSU.

4. ETSU, under the direction of its Trustees, enters this contract pursuant to Tenn. Code Ann. § 49-8-105(b), as amended effective May 11, 2023, to operate a training school for students in grades K—12.

5. While Tennessee law authorizes ETSU and Board to contract for the operation of pre-K, ETSU does not currently offer pre-K at the School and this agreement does not require it to add pre-K. If the Parties decide to add pre-K to the School operations, the Parties may amend this agreement to that effect.

C. Financial

1. The Board shall allocate state and local county education funds to ETSU in an amount equal to the per-student state and local funds allocations the Board receives. Funding sources shall include: TISA funding (base, weighted, direct, and outcomes-based), equalization funds, state capital outlay funds, and enumerated other funds limited to an ADA proportional share of sales tax, property tax, interest and penalty on delinquent tax, business tax, and marriage license tax.

2. To the extent the Board receives state and/or federal funds, including grant funds, based upon the School's students, the Board shall allocate those funds, except as referenced herein, to ETSU based on the method utilized to calculate the state or federal funding allocations to the Board. These methods include, but are not limited to, allocations determined based on the direct certified student population in a school, and TISA outcomes funding based on school's performance percentage.

3. The Board shall include the School in any capital or special funding requests from local, state, or federal funding sources.

4. During the first fiscal year of the term of this Agreement and each subsequent fiscal year during the term of this Agreement, the Board shall pay the allocation to ETSU from the allocations the Board receives from per pupil state and local education funds in ten (10) installments, each installment being due and payable on or before the 20th day of the month during said fiscal year as the Board receives allocations from state and local education funds. The Board shall not pay installments of state funds in May and July but shall pay installments of local funds. The first installment is due and payable on or before August 20 of each academic year. The Parties acknowledge and understand that Board will make payments to ETSU from funds the Board receives from state and local education funds.

5. The Board and ETSU shall comply with the provisions of state and federal laws that govern the allocation, receipt, and reporting of per student state, local, and federal funds the Board receives and all allocations under federal law or regulation, including, but not limited to, Title I, Title II, and Every Student Succeeds Act (ESSA) funds. As needed, the Board may act as fiscal agent for grant funds that the grantor has specifically identified for ETSU or which Board obtained because of ETSU, in compliance with this Agreement, state, and federal laws, and in compliance with such regulations as provided by the Tennessee Department of Education.

6. ETSU shall be responsible for reimbursing the Board for all fines, including, but not limited to, all fees and lost revenue, known or unknown at the time of the violation, that the Board incurs because of ETSU's actions. For all such violations, the Board reserves the right to not renew this agreement, revoke the agreement, or withhold funds from ETSU.

7. The Parties understand that they are responsible for their respective Other Post-Employment Benefits. The Parties will amend this Section of the Agreement according to any changes in the law.

8. ETSU shall own all property, improvements, furnishings, and equipment purchased with public funds, subject to complete satisfaction of any lawful liens or encumbrances. ETSU shall submit all required compliance documents for federal programs to the Board's Office of Federal Programs and Grants by the designated deadlines. Further, ETSU shall make all expenditures with federal funds in compliance with federal laws and regulations governing use of the funds.

9. ETSU shall be responsible for using allocated funding exclusively for operation, administration, employment, and other expenses of the School.

D. Admission and Enrollment

1. **Non-discrimination.** The School shall make student recruitment and enrollment decisions in a non-discriminatory manner and without regard to race, ethnicity, religion, national origin, English language proficiency, academic or athletic ability, sexual orientation or the need for special education and related services. The School will enroll students consistently with all applicable state and federal laws.

2. **Admissions and enrollment process.** The Board shall have no responsibility for the School's admission and enrollment process, except for allowing the School the option to access PowerSchool or other student management system for purposes of student scheduling, reporting, and data management.

3. **Tuition.** Nothing in this Agreement shall restrict School's ability to charge tuition to non-county resident students, if at any time, School determines it is in School's best interest to do so.

E. Curriculum and Instruction

1. **Statutory and Regulatory Compliance.** ETSU operates the School under the direction of its Trustees, which put the School wholly under the control of the ETSU president; therefore, ETSU shall have independent authority regarding the design and implementation of its educational program, but shall operate its academic programs in accordance with state and federal law as well as according to the standards prescribed by the Tennessee State Board of Education for the Tennessee public school system.

2. **Academic Calendar.** The School shall develop its instructional calendar in its sole discretion in accordance with state and federal laws.

3. **Assessment.** The School will perform assessments in accordance with state and federal mandates and in alignment with the School's curriculum. The School may perform any supplemental assessments beyond state and federal mandates in its discretion. The Board may use the School's assessment data for submission to the state Department of Education and in compliance with any other state or federally mandated data requirements for reporting educational progress. The Board may use the School's assessment data for any other purpose only in accordance with any data sharing agreements or otherwise with ETSU's prior written approval.

F. Student Administration

1. **Policies.** ETSU operates the School under the direction of its Trustees, which put the School wholly under the control of the ETSU president; therefore, ETSU has independent authority to adopt policies in its discretion and in accordance with state and federal law. The School may, in the exercise of its sole discretion, adopt and adhere to the Board's policies as set forth in the _____ Schools' student and parent handbooks and policy manuals, including utilization of the processes and procedures set forth therein.

2. **Student Discipline and Due Process.** The School shall administer its discipline policy in accordance with its policies and applicable state and federal law. The School shall ensure that it protects its students' due process rights, including through provision of appropriate hearings. The School shall promptly notify the Board of students it expels. Board shall provide the School's expelled students access to the Board's alternative school programs in the same manner as it provides access to any student within the LEA. If the expelled student came to the School from a public school system outside the Board's authority, the School and the Board may refer the expelled students to their home school. The School shall reimburse to the Board state and federal funds allocated to the School for students enrolled in the School who are subsequently expelled, referred to, and attend a Board alternative school. The School and the Board shall calculate the reimbursement amount based on the number of days the student(s) attended the Board's alternative school. Expelled students shall not be eligible to return to the School.

3. **Title IX and Child Abuse Reporting.** The School shall comply with Title IX of the Education Amendments Act of 1972 and state of Tennessee child abuse reporting requirements.

ETSU and/or the School, as determined in ETSU's sole discretion, shall fully perform investigations, and required actions of any reported Title IX and/or child abuse matters. ETSU and/or the School shall retain full responsibility for the personnel management and/or discipline of the School's employees and students as it relates to such allegations.

G. Food Services

The Board shall provide cafeteria services, including staffing and kitchen and food service equipment needed to provide such services, for the School in the same manner as it provides food services for other schools within the local education agency ("LEA"), including appropriate inspection and repair. Equipment already installed and in use is sole property of School. Board will provide meals in accordance with federal and state laws. The Board shall retain any of the School's state and federal funds, received pursuant to Tennessee Code Annotated, Section 49-8-105, and use those funds for the food services referenced herein.

H. Transportation

1. Board shall be responsible for providing transportation services to students requiring such services as provided in the students' IEPs or Section 504 plans but shall not be responsible for providing any other transportation services for the School's students except that the Board will provide limited bus services that have been provided in the past relationship between the parties.

I. Information Technology and Support

1. The Board will allow the School to access technical/helpdesk support provided by Board vendors for current or future programs provided for state/federal funding sources (such as student management system, universal screener, state required testing materials, systems, and software, etc.)

2. Except as stated above, ETSU shall be responsible, financially, and otherwise, for IT services for the School.

J. Exceptional Education

1. The Board shall be legally responsible as the LEA for special education services for students who are eligible under the Individuals with Disabilities Education Act Section 504 of the Rehabilitation Act of 1973 (Section 504) and Tenn. Code Ann. § 49-10-101 *et seq.* Board is responsible for ensuring that the School complies with federal and state special education laws and regulations, and that School provides special education and related services in the same manner as provided in the Board's schools. Additionally, the Board will oversee the School's procedural compliance with the previously mentioned federal and state laws and regulations concerning accommodations for and education of students with disabilities.

2. Individuals or agencies qualified to provide exceptional education services shall provide all exceptional education services at the School. Board shall be responsible for hiring, training, and employment of site staff necessary to provide exceptional education services to students, including without limitation, gifted education teachers, resource teachers, special education teachers, speech therapists, nurses/health assistants, occupational and physical therapists, and one-on-one educational assistants or assigned educational assistants. Staffing of the instructional resource positions will be based on the total IEP service hours of the students served, in the same manner as with other Board

schools. Regarding Board staffing placed at the School, ETSU and/or the School shall have all rights of selection, rejection, or removal that LEA principals exercise over staff assigned to their schools.

3. The Board shall retain all state and federal funding received by the Board for the provision of services in this Section J in exchange for the provision of the exceptional educational services referenced in this Section. If the Board does not provide those services, the Board will pass those funds through to the School to hire appropriate staff.

K. Procurement

The Board will provide the School with access to instructional materials, as available, including textbooks, musical instruments, curricular materials, and online learning platforms (*e.g.*, Canvas, AIMSweb, *etc.*). The Board will allow access to other supplies, materials, and goods/services at its discretion. ETSU shall bear the full responsibility and cost for procurement of any supplies, materials, IT equipment, and other goods/services this Agreement does not require the Board to provide or facilitate for the School. For purposes of this subparagraph, “facilitate” may include, but is not limited to, permitting ETSU to “piggyback” on an existing contract for goods and services the Board procured.

L. Personnel

1. **ETSU Employees.** Except as stated otherwise, ETSU will employ the School’s administrative, instructional, and support staff, subject to exceptions designated herein. ETSU shall be responsible for salaries, assignment, supervision, performance management and evaluation, retention, promotion, discharge, and control of such employees, and shall be solely responsible for salaries and associated benefits. The Board will employ the School’s special education and cafeteria staff.

2. **Exception from teacher tenure provisions.** Board acknowledges that instructional staff employed by ETSU shall not be subject to Teachers’ Tenure Act, Tenn. Code Ann. § 49-5-501 *et seq.*, and shall not accrue or be eligible for tenure under said statute while ETSU employs them.

3. The School’s employees who are qualified under state law to participate in the Tennessee Consolidated Retirement System (“TCRS”) will become and/or remain part of TCRS or any successor governmental retirement system. Employees who separate from employment with the School to accept a teaching position at a school in the Board’s system shall receive service credit as allowed by law for the purpose of establishing salary and retirement service credit under the TCRS system. The School will be responsible for providing any retirement benefits for the School employees who do not qualify for TCRS.

M. Board’s Use of University School Data

1. The School shall allow the Board to use the School’s data and test results for inclusion in district wide reporting. The School shall supply in a timely manner all reports, data, test results, and other information required by state and federal law necessary for the Board to comply with applicable submissions.

2. The Board shall only use data received through these reporting requirements in accordance with the purposes defined in the Family Educational Rights and Privacy Act, and any agreements prepared for data sharing purposes. The Board shall not use the data for any other purpose.

N. Research and Proprietary Works.

1. The Board acknowledges that ETSU owns and shall own all existing, and hereafter created, copyrights and other intellectual property rights with respect to all works of authorship, inventions and work product, including instructional materials, training materials, curriculum and lesson plans, and any other materials, teaching methodologies, school management methodologies, and all improvements, modifications, and derivative works thereof that are created, invented, or developed by ETSU's or the School's employees, agents, or contractors.

2. Any data use and sharing agreements between ETSU and the Board shall govern this Agreement. The Parties incorporate herein by reference any such agreements, whether existing now or in the future.

O. Records and Audits.

1. ETSU and the School shall make, keep, and accrue full and complete books, documents, accounting records, and other evidence that specifically relate to this Agreement in accordance with generally accepted accounting principles. ETSU shall retain such records, and shall make them available to the Board upon reasonable request during the term of this Agreement and for a minimum period of 5 years thereafter. If either Party institutes any litigation, claim, or audit before the expiration of the required retention period, ETSU shall retain the records until the Parties resolve the litigation, claim, or audit finding. ETSU shall furnish copies of the records to the Board upon request at the Board's expense, as calculated in accordance with the cost provisions of the Tennessee Public Records Act, Tenn. Code Ann. § 10-7-503(a)(7)(C).

2. Upon reasonable notice, ETSU shall permit the Board, any other governmental entity, any agency participating in the funding of this Agreement, or any of their duly authorized representatives, to enter the School's offices during regular business hours or otherwise as agreed to interview employees and to inspect and/or copy the records and books of accounts together with any documents pertaining hereto that the School may keep, maintain, or possess. The Board shall pay any cost associated with production or inspection of the records and books of accounts as calculated in accordance with the cost provisions of the Tennessee Public Records Act, Tenn. Code Ann. § 10-7-503(a)(7)(C).

3. Pursuant to state laws, rules, and regulations, ETSU shall keep financial records of the School's operations, including revenues and expenditures. ETSU shall provide to the Board a detailed accounting, including the amounts and sources of funds, upon reasonable request.

P. Term and Termination

1. This Agreement shall be effective for a period of five years from the date of execution.

2. Either party may terminate this Agreement for convenience by giving at least two (2) full school years notice to the other party in advance of the renewal date of _____. If it is determined that ETSU cannot continue operation of the School, ETSU may at its option terminate

this Agreement immediately. Further, if the State of Tennessee or the local government does not budget or appropriate sufficient funds for operation of the School either party may terminate this Agreement.

3. Upon expiration or termination of this Agreement for any reason, the Parties agree to cooperate in good faith and use their best efforts to complete a prompt and orderly separation, it being the intention of both Parties that the School shall remain open and operating in its normal course in the event of such expiration or termination of this Agreement, in accordance with the following rights and obligations of the Parties:

- a. The Parties shall facilitate the transfer of data, written and electronic, not currently in the other's possession, and necessary to fulfil any state or federal requirements including, but not limited to, student records, financial reports, and other academic data.
- b. Board will provide the School with reasonable educational and operational transition assistance for a period of 60 days after the termination of this Agreement. Likewise, ETSU will provide the Board with reasonable education and operational transition assistance for a period of 60 days after the termination of this Agreement.

Q. General Terms

1. **Governing Law.** The laws of the State of Tennessee shall govern the validity, construction, and effect of this Agreement and any extensions and/or modifications thereof by. Tennessee law shall govern regardless of any language in any attachment or other document that the Board may provide.

2. **Claims.** Neither party shall be responsible for personal injury or property damage or other loss except that resulting from its own negligence or the negligence of its employees or others for whom the party is legally responsible. The Tennessee Claims Commission or the state or federal courts in Tennessee shall be the venue for all claims, disputes, or disagreements arising under this Agreement. The Board acknowledges and agrees that any rights, claims, or remedies against ETSU, the School, the State of Tennessee, or their employees arising under this Agreement shall be subject to and limited to those rights and remedies available under Tenn. Code Ann. §§ 9-8-101—408.

3. **No Conflict of Interest.** The Parties represent that they have not paid and will not pay any fee directly or indirectly to any officer or employee of the other party as wages, compensation, or gifts in exchange for acting an officer, agent, employee, subcontractor, or consultant to that party in connection with this Agreement.

4. **Illegal Immigrants.** Per Tennessee law, neither party will knowingly utilize the services of illegal immigrants in the employment performance of this Agreement and will not knowingly utilize the services of any subcontractor, if permitted under this Agreement, who will knowingly utilize the services of illegal immigrants in the performance of this Agreement.

5. **Non-Discrimination.** The Parties shall not exclude any person from participating in or benefiting from this agreement on the grounds of disability, age, race, color, religion, sex, national origin, veteran status, or any other classification protected by Federal and/or Tennessee State constitutional and/or statutory law.

6. **Section Headings.** The headings in this Agreement are for the convenience of the Parties only and shall have no effect on the construction or interpretation of this Agreement and are not part of this Agreement.

7. **Entire Agreement.** This Agreement sets forth the entire agreement between the Parties with respect to the subject matter hereof and shall govern the respective duties and obligations of the Parties. This Agreement supersedes all prior understandings and agreements, expressed or implied, written or oral, between the Parties.

8. **Modifications and Amendments.** The Parties may modify this Agreement only by executing a written modification or amendment.

9. **Assignment.** The Parties shall not assign, subcontract, transfer (whether by assignment or novation) the work, services, or any interest in this Agreement without the prior written consent of the other Party.

10. **No Partnership/Joint Venture.** The Parties do not intend to create a partnership or joint venture through this Agreement. Neither the Parties nor any court of law shall interpret or construe this Agreement as creating a partnership or joint venture between the Parties. Nor shall the Parties or any court of law interpret or construe this Agreement as creating a principal-agent relationship between the Parties. Neither of the Parties shall hold itself out in a manner contrary to the terms of this paragraph.

11. **Severability.** If any court of competent authority declares any provision of this Agreement invalid, the court shall sever the invalid provision and the severance shall not affect the validity of the remaining provisions of this Agreement.

12. **Negotiated Agreement.** The Parties negotiated and jointly drafted the terms of this Agreement.

13. **Approvals.** By signing this Agreement, both Parties acknowledge that they have received the appropriate approvals from their governing agency.

14. **Laboratory/Teaching School.** The Parties intend for ETSU to maintain the School as a laboratory/teaching school in accordance with Tenn. Code Ann. § 49-8-105, as amended effective May 11, 2023, and as the General Assembly may amend the Act from time to time. The Parties and the courts shall interpret and construe this Agreement to effectuate that purpose. This Agreement shall be automatically amended to conform with any subsequent amendments to the Act, unless the Parties agree otherwise in writing in accordance with section Q, paragraph 8. Any provision of this Agreement that contravenes the Act shall be deemed invalid.

IN WITNESS WHEREOF, the Parties have hereunder set their hand.

EAST TENNESSEE STATE UNIVERSITY

Brian Noland
President

_____ SCHOOLS
BOARD OF EDUCATION

[NAME]
Superintendent