



**Edinburg Consolidated Independent School
District**

Regular

Tuesday, November 30, 2010 6:00 PM

Agenda of Regular Meeting

The Board of Trustees Edinburg Consolidated Independent School District

A Regular Meeting of the Board of Trustees of Edinburg Consolidated Independent School District will be held November 30, 2010, beginning at 6:00 PM in the Board Room, 411 North 8th Street; Edinburg, Texas 78541.

It is the policy of Edinburg CISD not to discriminate in its educational programs based on sex, age, religion, race, color, national origin, or handicap. *Es la poliza del distrito escolar de Edinburg de no discriminar en sus programas educativos por razon de sexo, edad, religion, raza, color, origen nacional o por incapacidad.*

The subjects to be discussed or considered or upon which any formal action may be taken are as listed below. Items do not have to be taken in the order shown on this meeting notice.

Unless removed from the consent agenda, items identified within the consent agenda will be acted on at one time.

1. CALL MEETING TO ORDER, CONDUCT ROLL CALL, ESTABLISH QUORUM
Presenter: President David Torres
Time: 6:00 PM
2. PRAYER, PLEDGE OF ALLEGIANCE, AND TEXAS PLEDGE
Presenter: Mr. Ciro Trevino
3. CERTIFICATION OF PUBLIC NOTICE
Notice was posted in the Edinburg CISD Administration Building at 411 North 8th Street in Edinburg, Texas on November 23, 2010 at 6:00 p.m. signed Dr. René Gutiérrez, Superintendent of Schools.
Presenter: President Torres
4. AWARDS & RECOGNITION
Presenter: Superintendent Rene Gutierrez
 - A. Career & Technical Education Robotic Teams of South Middle, Edinburg High, and Brewster Schools Compete in 2010 Coastal Bend BEST Robotics Competition
 - B. National Hispanic Merit Scholar Recipients from Economedes High School
5. PUBLIC COMMENTS
Public participation is limited to the designated open forum portion of the meeting. At all times during board meetings, the audience shall not enter into

discussion or debate on matters being considered by the Board, unless recognized by the Board President. No presentation shall exceed five minutes.

Presenter: Superintendent Gutierrez

6. SUPERINTENDENT'S REPORT

Presenter: Superintendent Gutierrez

- A. Presentation of 2010 Cash Dividend to Edinburg CISD by Property Casualty Alliance of Texas
- B. Enrollment as of November 19, 2010
- C. Teacher Vacancies

7. CONSENT AGENDA

The following item(s) are of a routine or administrative nature. All items are to be acted on by one vote without being discussed separately, unless requested by a board member in which case the item(s) will be considered individually after the items not requiring discussion have been acted on.

Presenter: President Torres

- A. (011B- 1) Minutes for Special Called Board Meetings of November 3, 2010 and November 10, 2010, and Regular Board Meeting of November 10, 2010 6
- B. (011B- 2) BuyBoard 11-51 Two Tilting Skillet/Braising Pans for B. L. Garza Middle School COST \$22,972.78 SOURCE Child Nutrition Funds 16
- C. (011B- 3) Contract with Gretchen Bernabie to Provide Training for Writing Teachers District Wide for 2010-2011 School Year COST \$12,500.00 SOURCE Federal Funds 18

8. ACTION AGENDA

Presenter: President Torres

- A. (011B- 4) GoDirect 11-58 Servers and Storage Area Network for Technology Department COST \$66,805.21 SOURCE Local Funds 23
- B. (011B- 5) Updated Courseware and Services from Plato Learning for Edinburg, Edinburg North, and Economedes High Schools, and Edinburg Alternative Education Academy COST \$172,285.00 SOURCE State Compensatory Funds 28
- C. (011B- 6) Interlocal Agreement Between City of McAllen and Edinburg CISD for *Safe Routes to School* Project COST \$30,000.00 SOURCE Local Funds 44
- D. (011B- 7) Interlocal Agreement Between Hidalgo County and Edinburg CISD for *Safe Routes to School* Project 51
- E. (011B- 8) Interlocal Agreement Between City of Edinburg and Edinburg CISD for *Safe Routes to School* Project COST \$420,000.00 SOURCE Local Funds 58
- F. (011B- 9) Agreement Between Texas A & M University System Health Science Center Research Foundation and Edinburg CISD for Park Improvements at Villarreal and Monte Cristo Elementary Schools 65

- | | | |
|-------------------------------------------------------------------------------------------------------------------------------------------------------------------|-------------------------------------------|-----|
| G. (011B-10) 2010-2011 Capital Improvement Projects
SOURCE Local Funds | COST \$1,000,000.00 | 73 |
| H. (011B-11) Macaria Gorena Elementary School Utility Easement | | 88 |
| I. (011B-12) Group E Robert Vela High School for Milnet Architectural
Services Contract Amendment
2008 Bond Funds | COST \$212,125.00 SOURCE Construction | 93 |
| J. (011B-13) Change Order 2 for Group C Fine Arts Facilities
2008 Bond Funds | REDUCTION \$16,144.00 SOURCE Construction | 99 |
| K. (011B-14) Construction Contingency Authorization 4 for Group C Fine Arts
Facilities | COST \$9,477.00 SOURCE Construction | 102 |
| L. (011B-15) BID 11-16 Air Conditioner Filter Media | COST \$34,000.00 | 105 |
| M. (011B-16) BID 11-26 Replacement of Air Handler Units at Edinburg North
High School | COST \$61,630.00 SOURCE Local Funds | 119 |
| N. (011B-17) BID 11-63 Building Automation Controls Upgrade at South
Middle School from Texas Multiple Award Schedule | COST \$77,127.64
SOURCE Local Funds | 125 |
| O. (011B-18) RFP 10-207 Security Camera Systems for Brewster School
Additions, and Edinburg, Economedes, and Edinburg North High School Fine
Arts Buildings | COST \$173,731.96 SOURCE Construction | 148 |
| P. (011B-19) Employment, Resignations, and Retirements | | |

9. CLOSED SESSION

Discussion under the authority of Section 551, Texas Government Code: If, during the course of the meeting covered by this Notice, the Board should determine that a Closed Session of the Board should be held or is required in relation to any item included in this Notice, then such closed session as authorized by Section 551.001 et. seq. of the Texas Government Code (the Open Meetings Act) will be held by the Board after the commencement in Open Session of the meeting covered by this Notice. Such closed session may concern any or all of the subjects and be conducted for any and all purposes permitted by Section 551.071 through and including Section 551.084 of the Texas Open Meetings Act, including, but not limited to, private consultation with the Board's attorney on any or all subjects or matters authorized by law.

Presenter: President Torres

- A. Section 551.071--Consultation with Attorney on Any Permitted Subject Including, But Not Limited to:
1. Discussion with School Attorney of Item(s) Exempted under Attorney-Client Privilege
 2. Update on Pending Litigation
- B. Section 551.072--Deliberation Regarding Real Property

1. Discussion on Acquisition of Possible Land Donation for Future Development
2. Discussion on Proposed Contracts for Land Purchases
- C. Section 551.074--Personnel Matters
 1. Discussion of Employment, Resignations, and Retirements
 2. Update of Pending Personnel Investigations
- D. Section 551.071--Consultation with Attorney & Section 551.074--Personnel Matters
- E. Section 551.082--Discipline of a Public School Child
10. ACTION ON ITEMS DISCUSSED IN CLOSED SESSION
Presenter: President Torres
 - A. Section 551.071--Consultation with Attorney
 - B. Section 551.072--Deliberation Regarding Real Property
 - C. Section 551.074--Personnel Matters
11. ADJOURNMENT
Presenter: President Torres

APPROVAL OF BOARD MINUTES

Superintendent's Recommendation

Board of Trustees approval of the minutes for the following board meeting(s):

Special Called Board Meeting on November 3, 2010
Special Called Board Meeting on November 10, 2010
Regular Board Meeting on November 10, 2010

Rationale

Article 6252-17A, §3b, V.A.T.S. requires in part that the Board shall prepare and retain minutes of each of its open meetings. The minutes are public record and shall be available for public inspection and copying upon request to the Superintendent or his designee.

Paperwork Impact

No additional paperwork will be generated.

Budgetary Information

The budget will not be impacted.

Resource Personnel

Dr. René Gutiérrez

Board Policy Reference and Compliance

This item is in compliance and in accordance with Board Policy BE and BE (Local).

Prepared by



Mary Alice S. Martin, Board Secretary

Recommended by

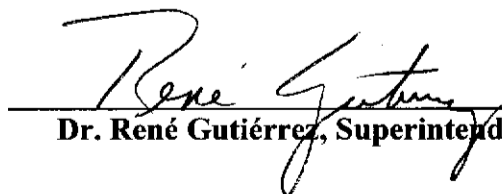

Dr. René Gutiérrez, Superintendent of Schools

EXHIBIT A, PAGES 1-9

EDINBURG CONSOLIDATED INDEPENDENT SCHOOL DISTRICT
Edinburg, Texas

STATE OF TEXAS §

COUNTY OF HIDALGO §

November 3, 2010

On the 3rd day of November 2010, the **Board of Trustees** for the Edinburg Consolidated Independent School District met in **special session** with the following members present:

Omar Palacios, President
Ciro Treviño, Secretary

Carmen González, Member
David Torres, Member

Absent from the meeting were Vice President Robert Peña Jr. and Members Jaime R. Chavana and Gregory "Greg" García.

President Palacios, who established **quorum**, called the meeting to order at 5:30 p.m. He then asked for certification that **Public Notice** had been posted in Edinburg CISD Administration Building at 411 North 8th Street in Edinburg on November 5, 2010 at 5:30 p.m. signed Dr. René Gutiérrez, Superintendent of Schools.

President Palacios recessed the meeting at 5:31 p.m. to **Conduct Agenda Item 3 Walk Through of Fine Arts Facility at Edinburg North High School.**

President Palacios reconvened the meeting at 5:50 p.m.

Mr. Ciro Treviño moved and Mrs. Carmen González seconded the motion to **Approve Agenda Item 4 Substantial Completion for Fine Arts Facility at Edinburg North High School Effective November 3, 2010**, as recommended by Superintendent René Gutiérrez. The motion carried.

Mr. David Torres moved and Mrs. Carmen González seconded the motion to **adjourn**. The motion carried.

President Palacios adjourned the meeting at 5:54 p.m.

OMAR PALACIOS
President of the Board of Trustees

ATTESTED BY

CIRO TREVINO
Secretary to the Board of Trustees

EXHIBIT A

EDINBURG CONSOLIDATED INDEPENDENT SCHOOL DISTRICT
Edinburg, Texas

STATE OF TEXAS §

COUNTY OF HIDALGO §

November 10, 2010

On the 10th day of November 2010, the Board of Trustees for the Edinburg Consolidated Independent School District met in **special session** with the following members present:

Omar Palacios, President
Robert Peña Jr., Vice-President
Ciro Treviño, Secretary

Jaime R. Chavana, Member
Carmen González, Member
David Torres, Member

Absent from the meeting were Members Gregory "Greg" García.

Present at the request of the superintendent was Jacques E. Treviño, board attorney.

NOTE: If more detailed information regarding the presentations, discussion, and action taken during the meeting is desired, the audio and video taped recordings are available through the superintendent's office.

President Palacios, who established **quorum**, called the meeting to order at 5:38 p.m. He then asked for certification that **Public Notice** had been posted in the Edinburg CISD Administration Building at 411 North 8th Street in Edinburg, Texas on November 5, 2010 at 6:00 p.m. signed Dr. René Gutiérrez, Superintendent of Schools.

Assistant Superintendent Mario Salinas conducted **Agenda Item III Canvassing of Votes for Trustee Election Held on November 2, 2010** by reading aloud the Total Votes Cast (Provisional, Absentee, Early, and Election Day Ballots) by Precincts for Each Candidate as follows: **Place 1 Juan Palacios Jr Total Votes 5,626; Place 2 Jaime R. Chavana Total Votes 5,572; Total Votes Cast for Place 3 David Torres 5,136 and 3,071 for Regino "Reggie" Salinas; and for Place 5 Gregory "Greg" Garcia 3,967 and Martin Castillo 4,172** (Exhibit is included with minutes.).

Mrs. Carmen González moved and Mr. Ciro Treviño seconded the motion to **Approve Agenda Item IV Order Declaring Results of Trustee Election of November 2, 2010**. The motion carried.

Superintendent Gutiérrez conducted **Agenda Item V Presentation of Certificates of Election to Juan Palacios Jr. for Place 1, Jaime R. Chavana for Place 2, David Torres for Place 3, and Martin Castillo for Place 5**.

For **Agenda Item VI Oath of Office Administered to Newly-Elected Board Members**, Judge Homero Garza administered the Oath of Office to David Torres for Place 3. For Place 2, Judge Juan Partida administered the Oath of Office to Jaime R. Chavana. Judge Ricardo Rodriguez administered the Oath of Office to Martin Castillo for Place 5. For Place 1, Mayor Richard H. Garcia administered to Oath of Office to Juan Palacios Jr.

As a token of appreciation for their dedication to the Edinburg CISD students and staff, Superintendent Gutierrez presented plaques (**Agenda Item VII**) to outgoing Board President Omar Palacios and Board Member Gregory "Greg" García acknowledging their 4 and 10 years of service, respectively.

EXHIBIT A-2

EDINBURG CISD SPECIAL-CALLED BOARD MEETING

November 10, 2010

Page 2

President Palacios expressed his thanks to fellow board members and administration for making his tenure a memorable and successful one. In spite of difficult financial times, the ECISD community has seen improvements to district facilities and test scores, and fortunately, have not had to lay off any staff members. However, he did come to the realization that he would be unable to dedicate the time needed to carry out the duties and responsibilities as a board member, therefore, decided not to run again. Mr. Palacios expressed his gratitude to the individuals that supported him during his campaign and tenure as an ECISD board member. He expressed his thanks and love to his wife and family for their support and sacrifices they made so that he could fulfill his commitment to Edinburg CISD.

Under **Agenda Item VIII Reorganization of Board of Trustees**, Vice President Peña called for nomination(s) for **Board President**.

Dr. Martin Castillo moved and Mr. Juan Palacios Jr. seconded the motion for **Agenda Item VIII Reorganization of Board of Trustees by Nominating David Torres as President**. The motion carried.

President Torres called for nomination(s) for Board Vice President.

Dr. Martin Castillo moved and Mr. Juan Palacios Jr. seconded the motion to **Nominate Carmen González as Board Vice-President**. The motion carried.

President Torres then called for nomination(s) for Board Secretary.

Dr. Martin Castillo moved and Mrs. Carmen González seconded the motion to **Nominate Ciro Treviño as Board Secretary**. The motion carried.

Mrs. Carmen González moved and Mr. Robert Peña Jr. seconded the motion to **adjourn**. The motion carried.

President Torres adjourned the meeting at 6:04 p.m.

DAVID TORRES
President of the Board of Trustees

ATTESTED BY

CIRO TREVINO
Secretary to the Board of Trustees

EXHIBIT A-3

ECISD Trustee Elections November 2010 Election Day Totals By Precinct/Grand Totals

November 2, 2010	Juan Palacios, Jr.	Jaime R. Chavana	David Torres	Regino "Reggie" Salinas	Gregory "Greg" Garcia	Dr. Martin "Doc" Castillo, Jr.
GRAND TOTAL	5,526	5,572	5,136	3,071	3,957	4,172
South MS	13	209	164	90	139	115
Jefferson Elem	14	275	233	135	176	188
JFK Elem, Elsa	15	7	7	6	2	8
Hargill Elem	18	20	42	17	20	34
St. Anne Church, San Manuel	19	34	32	15	25	22
McCook Bldg	24	22	18	10	13	15
ENHS	30	76	70	26	49	48
Memorial MS	31	60	53	23	36	44
San Carlos Elem	43	63	113	53	78	81
Canterbury Elem	52	189	159	86	121	123
Barrientes MS	53	259	213	147	186	165
Cavazos Elem	54	69	50	35	46	37
Camp Loma de Vida	68	110	88	75	83	63
Camp Loma de Vida	69	90	68	43	52	58
Gonzalez Elem, McAllen	73	0	0	0	0	0
Salinas Elem, Mission	75	0	0	0	0	0
McCook Bldg	76	3	3	2	4	2
Salinas Elem, Mission	89	0	0	0	0	0
San Carlos Elem	104	38	53	28	37	43
BL Garza MS	105	214	164	85	108	138
Canterbury Elem	106	309	230	148	204	168
South MS	107	156	127	76	107	98
Lincoln Elem	108	118	123	58	82	108
Edbg Fire Station	109	119	100	55	74	76
Barrientes MS	110	47	33	33	36	34
Elsa City Hall	119	7	5	2	5	2
Cavazos Elem	129	14	11	6	8	5
Election Day Totals	2,483	2,508	2,159	1,254	1,691	1,675
Early Vote Totals	3,094	3,014	2,934	1,781	2,231	2,464
Absentee Totals	13	14	16	7	15	10
Provisional Totals Early Voting	26	26	18	24	22	17
Provisional Totals Election Day	10	10	9	5	8	6

EDINBURG CONSOLIDATED INDEPENDENT SCHOOL DISTRICT
Edinburg, Texas

STATE OF TEXAS §

COUNTY OF HIDALGO §

November 10, 2010

On the 10th day of November 2010, the **Board of Trustees** for the Edinburg Consolidated Independent School District met in **regular session** with the following members present:

David Torres, President	Martin Castillo, D.C., Member
Carmen González, Vice President	Jaime R. Chavana, Member
Ciro Treviño, Secretary	Juan Palacios Jr., Member
	Robert Peña Jr., Member

Present at the request of the superintendent was Jacques E. Treviño, board attorney.

NOTE: If more detailed information regarding presentations, discussion, and action taken during the meeting is desired, the audio and video taped recordings are available through the superintendent's office.

President Torres, who established **quorum**, called the meeting to order at 6:20 p.m. Mrs. Carmen González offered the **prayer and led the Pledge of Allegiance and Texas Pledge**.

President Torres asked for certification that **Public Notice** had been posted in the Edinburg CISD Administration Building at 411 North 8th Street in Edinburg, Texas on November 5, 2010 at 6:00 p.m. signed Dr. René Gutiérrez, Superintendent of Schools.

Under Awards & Recognition:

- A. National Hispanic Merit Scholar Recipients from Edinburg North High School
- B. All Region Orchestra Members from South, Barrientes, Memorial and Harwell Middle Schools, and Edinburg, Edinburg North, and Economedes High Schools
- C. Division I Earned at the UIL Pigskin Competition by Marching Bands of Edinburg, Edinburg North, and Economedes High Schools
- D. Career & Technical Education FordPAS Students from South Middle School Achieve National Recognition
- E. Presentation of TEA *Exemplary and Recognized* Accountability Ratings and *Adequate Yearly Progress* Performance Awards

Under **Public Comments**, **Luis Tovar** stated that of the 700 American Federation of Teacher members surveyed from Edinburg CISD those that responded stated that a top priority is to have accessibility to the "health insurance" plan and that co-pays be reduced. The consensus is that many district employees are now hesitant to go to the doctor due to the higher co-pays; therefore, they feel that they pay for health insurance not health care. With the increase in suicides related to bullying at school, **Janette Reyes** asked for consideration to revising the current district policy regarding "bullying". She added that revision of the policy so that it is in line with the steps delineated in the letter from United States Department of Education Office of Civil Rights would protect the victim instead of the perpetrator as seems to be the case in the current district policy.

EXHIBIT A-5

Under Superintendent's Report:

- A. Update on Rezoning of Middle and High Schools
- B. Update on 2008 Bond Construction Projects by Broaddus & Associates
- C. USDE/Office of Migrant Education Onsite Monitoring Visit
- D. Texas English Language Proficiency Assessment System
- E. Enrollment as of November 5, 2010: +1,146 (as compared to 11/3/09)
- F. Teacher Vacancies: 10 (5 elementary/5 secondary)

CONSENT AGENDA ITEMS:

Mr. Robert Peña Jr. moved and Mrs. Carmen González seconded the motion to **Approve Agenda Items: 011A-1 Minutes for Regular Board Meeting of October 26, 2010; 011A-2 Bid 10-25 Towing Services District Wide, First and Final Contract Renewal with M & M Towing and Recovery Inc in the Amount of \$25,000.00; 011A-3 Bid 11-01 Janitorial Supplies, Cleaners and Related Items to Several Vendors for a Total \$29,069.65; 011A-4 Bid 11-04 Janitorial Supplies, Brooms, Mops and Related Items to Several Vendors for a Total of \$19,881.20; 011A-5 Bid 11-15 Poster Printer Supplies to Imagery Graphic Systems in the Amount of \$25,000.00; 011A-6 Bid 11-17 Lumber and Related Supplies to Lowe's Edinburg and South Texas Moulding for a Total of \$73,000.00; and 011A-7 GoDirect 11-44 Fortinet Software Contract Renewal for Technology Department to MicroShare Inc in the Amount of \$37,693.50**, as recommended by Superintendent René Gutiérrez. The motion carried.

ACTION AGENDA ITEMS

Mr. Jaime R. Chavana moved and Mrs. Carmen González seconded the motion to **Approve Agenda Item 011A-8 Amend Interlocal 11-18 District Wide Technology Equipment to CDW Government and Dell for a Total of \$965,080.00**, as recommended by Superintendent René Gutiérrez. The motion carried.

Mr. Jaime R. Chavana moved and Mrs. Carmen González seconded the motion to **Approve Agenda Item 011A-9 Interlocal 11-46 Replacement of Xerox Copiers through State of Texas Comptroller's Office and Texas Cooperative Purchasing Network to Xerox Corporation in the Amount of \$348,683.40**, as recommended by Superintendent René Gutiérrez. The motion carried.

Mr. Robert Peña Jr. moved and Mrs. Carmen González seconded the motion to **Approve Agenda Item 011A-10 RFP 10-193 Data Reporting System to Eduphoria in the Amount of \$88,400.00**, as recommended by Superintendent René Gutiérrez. The motion carried.

Mr. Jaime R. Chavana moved and Mr. Ciro Treviño seconded the motion to **Approve Agenda Item 011A-11 Maria Esther Morales as an Additional Administrator for 2010-2011 "Professional Development Appraisal System" Appraisers**, as recommended by Superintendent René Gutiérrez. The motion carried.

Mrs. Carmen González moved and Dr. Martin Castillo seconded the motion to **Approve Agenda Item 011A-12 Contract with Renaissance Learning Inc for Star Reading and Accelerated Reader Enterprise Program in the Amount of \$143,417.39**, as recommended by Superintendent René Gutiérrez. The motion carried.

EXHIBIT A-6

Mrs. Carmen González moved and Mr. Juan Palacios Jr. seconded the motion to **Approve Agenda Item 011A-13 Contract/Consultant Agreement with J Taylor Education for Staff Development in the Amount of \$23,505.00**, as recommended by Superintendent René Gutiérrez. The motion carried.

Mrs. Carmen González moved and Mr. David Torres seconded the motion to **Approve Agenda Item 011A-14 2010-2011 Commitment for Special Services Projects with Region One Education Service Center in the Amount of 435,406.23**, as recommended by Superintendent René Gutiérrez. The motion carried.

Mrs. Carmen González moved and Mr. Ciro Treviño seconded the motion to **Approve Agenda Item 011A-15 Resolution 2011-03 Setting the 2010 Tax Levy at 1.2398/\$100**, as recommended by Superintendent René Gutiérrez. The motion passed 5 to 1 with Robert Peña Jr. voting against.

Mrs. Carmen González moved and Dr. Martin Castillo seconded the motion to **Approve Agenda Item 011A-16 RFP 10-18 Self-Funded Medical Stop Loss Coverage and Administration Services, First Year Renewal with Blue Cross/Blue Shield of Texas in the Amount of \$2,556,894.00**, as recommended by Superintendent René Gutiérrez. The motion carried.

Mrs. Carmen González moved and Mr. Robert Peña Jr. seconded the motion to **Approve Agenda Item 011A-17 Changes to Health Insurance Plan Document as Required to Comply with the *Affordable Care Act***, as recommended by Superintendent René Gutiérrez. The motion carried.

Mr. Ciro Treviño moved and Mrs. Carmen González seconded the motion to **Approve Agenda Item 011A-18 Creative Education Institute Inc for Training and Software Licenses Using Essential Learning Systems and Mathematical Learning Systems in the Amount of \$141,300.00**, as recommended by Superintendent René Gutiérrez. The motion carried.

Mr. Jaime R. Chavana moved and Mr. Robert Peña Jr. seconded the motion to **Approve Agenda Item 011A-19 Bus Driver Special Education Job Description to Complement the Newly Amended Regular Bus Driver Job Description to Comply with Local Policies, TEA Requirements, and State Mandates**, as recommended by Superintendent René Gutiérrez. The motion carried.

Mr. Jaime R. Chavana moved and Mrs. Carmen González seconded the motion to **Approve Agenda Item 011A-20 Contracted Service Agreement with Margaret Kilgo of Kilgo Consulting Inc to Provide Training for English Language Arts School Teachers for the 2010-2011 School Year in the Amount of \$59,600.00**, as recommended by Superintendent René Gutiérrez. The motion carried.

Mr. Ciro Treviño moved and Mrs. Carmen González seconded the motion to enter **Closed Session**. The motion carried.

President Torres recessed the meeting at 8:20 p.m. enabling the Board to enter Closed Session. The motion carried.

Mr. Ciro Treviño moved and Mr. Robert Peña Jr. seconded the motion to return to **Open Session**. The motion carried.

After returning to Open Session at 9:40 p.m., President Torres announced that no action had been taken on items discussed in Closed Session.

EXHIBIT A-7

Mrs. Carmen González moved and Mr. Juan Palacios Jr. and Mr. Robert Peña Jr. seconded the motion to **Approve Section 551.074 9C.1a Employment of Cynthia Ann Flores as Educational Diagnostician in the Special Education Department**, as recommended by Superintendent René Gutiérrez. The motion carried.

Mr. Ciro Treviño moved and Mrs. Carmen González seconded the motion to **Approve Section 551.074 9C.2 (Agenda Item 011A-21) Employment, Resignations, and Retirements as Discussed in Closed Session**, as recommended by Superintendent René Gutiérrez. The motion carried.

Employment for 2010-2011

Consuelo Ramirez* BS/UT, Pan American 0-0 years experience

*Pending criminal background check

Resignations and Retirements

Rigoberto Abrego	Asst Supt for Finance & Operations
Juan Cuellar	Choir/South MS
LeAnna Gutierrez	Special Ed/Harwell MS
Juan Mendez	Special Ed/LBJ
Fernando Rosa	District Math Specialist/Adm Bldg
Dalia Escobar	1 st Grade, Bilingual/Guerra
Angelica M. Peralta	Speech Language Pathologist/Special Ed Office

Employment of Paraprofessionals (University Hours) and Classified Employees

Marissa Luna*	High School Diploma	0-0 years experience
Juan G. Mendoza*	UT, Pan American (56)	2-2 years experience
Roxana Rodriguez*/**	UT, Pan American/STC (58)	5-0 years experience
Carolina Saenz*	UT, Pan American (BS)	3-3 years experience
Elizabeth Matamoros-Hernandez*/#	Bus Monitor/Transportation	0-0 years experience
Jesus A. Araujo Arnada*/#	CN Custodian/Cavazos	0-0 years experience
Baltazar Beltran*/#	CN Custodian/Harwell MS	Pending
Mario Salinas*/#	CN Custodian/Guerra	0-0 years experience

*Pending criminal background check **Pending Fast Pass
#Pending district medical and employment requirements

Promotions (None)

Resignations and Retirements

Michael Barrera	Migrant Recruiter (NGS)/JFK
Priscilla Trigo	Aide/Esparza
Adela Villanueva	PEIMS Clerk/Harwell MS
Monica M. Garcia	Secretary/Police Department
Felicita Carrillo (Retiring)	Food Prep/Villarreal
Oscar Cantu (Retiring)	CN Custodian/LBJ

Employment of Interns/Tutors/Student Workers

Ramon Gutierrez*	America Reads/Lee
Rebecca Nava*	America Reads/Austin
Jason A. Castillo*	America Reads/Betts
Elizabeth Lara*	Gear Up/EHS
David Gutierrez III*	Financial Aide/EHS
Michelle N. Gutierrez*	Financial Aide/EHS
Armando Medina Jr*	Tutor/Memorial MS
Dante D. Pena*	Tutor/Vision Academy
Oscar M. Garcia*	Tutor/Vision Academy
Jorge Villarreal Barrera*	Tech Intern/Technology
Danny Lara*	Tutor/JEHS

*Pending district medical and employment requirements

Resignations

Daniel Trevino	Tutor/JEHS
----------------	------------

Employment of Special Education Shadows

Cynthia Maldonado	Crawford
-------------------	----------

Resignations

Julio Vasquez	ENHS
Iris Martinez	ENHS

Mr. Ciro Treviño moved and Mrs. Carmen González seconded the motion to **adjourn**. The motion carried.

President Torres adjourned the meeting at 9:42 p.m.

DAVID TORRES
President of the Board of Trustees

ATTESTED BY

CIRO TREVINO
Secretary to the Board of Trustees

EXHIBIT A-9

APPROVAL OF BUYBOARD 11-51, FOR THE PURCHASE OF TWO TILTING SKILLET/BRAISING PANS FOR B.L. GARZA MIDDLE SCHOOL

Superintendent's Recommendation

That the Board of Trustees approve the recommendation for Tilting Skillet/Braising pans through the Buyboard awarded contracts.

Rationale

The BuyBoard sought competitive sealed bids and have awarded a contract to Kitchen Resources, L.P. This contract complies with all bidding requirements as required by federal, state, and local laws. The two (2) tilting skillet/braising pans will be to replace old equipment not in working condition.

Budgetary Information

TOTAL AWARD RECOMMENDATION: \$22,972.78

Account	Description	Appropriations	Encumbrance	Expenditure	Balance
101-35-6639-00-043-199000	FURNITURE/EQUIPMENT	29,000.00	0.00	0.00	29,000.00
TOTALS		29,000.00	0.00	0.00	29,000.00

Resource Personnel

Dr. René Gutiérrez
Mario H. Salinas

Sylvia D. Garcia
Mary De Luna

Amaro Tijerina

Board Policy Reference

This is in accordance with the Board Policy CH, Purchasing Law Bidding Requirements.

Prepared by:

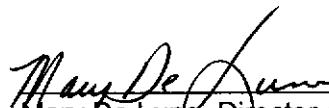
Mary De Luna, Director of Child Nutrition

Approved by:

Mario H. Salinas, Asst. Supt. for District Administration

Within Budgetary Allocations:

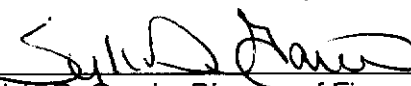
Sylvia D. Garcia, Director of Finance

Approved by:

Sylvia D. Garcia, Director of Finance

Recommended by:

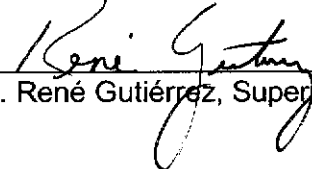
Dr. René Gutiérrez, Superintendent of Schools



Quote

11/3/2010

Project:
Edinburg ISD Braising pans

From:
Kitchen Resources, L.P.
Cathy Drummond
2102 Fair Park Blvd.
Harlingen, TX 78550
Phone: (956) 423-2491

BUYBOARD CONTRACT#355-10
QUOTE INCLUDES PRICE FOR INSTALLTION WHICH IS FOR THE DELIVERY AND SET IN PLACE, WITH DISCONNECT OF OLD EQUIPMENT.

Item	Qty	Description	Sell Each	Sell Total
1	2	ea TILTING SKILLET/BRAISING PAN, GAS Vulcan Hart Model No. VG30 Braising Pan, Gas, 30-gallon capacity, 36" wide open base, manual tilt, 9" deep s/s pan with gallon markings, pouring lip & removable strainer, spring assist cover with drip edge, pan holder, thermostatic control, includes L faucet bracket, electric ignition, 12" s/s legs with adjustable flanged feet, 90,000 BTU	10,322.23	20,644.46
	2	ea 1 year limited parts & labor warranty, standard		
	2	ea Gas type to be specified		
	2	ea 120v/60/1, 300w for controls, standard		
	2	ea Motor driven pan lift	633.80	1,267.60
	2	ea SGL12R 12NZZ SINGLE Pantry Deck Mount Faucet, w/12" riser & 12" swivel spout	166.92	333.84
		Installation	150.00	300.00
		Extended Total for Item No. 1:	\$22,545.90	
2	2	ea SAFETY SYSTEM MOVEABLE GAS CONNECTOR Dormont Manufacturing Model No. 1675KIT2S48 Safety System Moveable Gas Connector Kit, 3/4" inside dia., 48" long, covered with stainless steel braid, coated with blue antimicrobial PVC, 1 SnapFast™ QD, 2 SwivelMAX™, 1 full port valve, coiled restraining cable with hardware, limited lifetime warranty	213.44	426.88
		Extended Total for Item No. 2:	\$426.88	

Merchandise	22,972.78
Total	22,972.78

Thanks for the Opportunity to Quote!!!!

Edinburg ISD Braising pans

Kitchen Resources, L.P.

EXHIBIT _____

APPROVAL OF THE CONTRACT WITH GRETCHEN BERNABIE TO PROVIDE TRAINING FOR WRITING TEACHERS DISTRICT WIDE FOR THE 2010-2011 SCHOOL YEAR

Superintendent's Recommendation:

That the Board of Trustees approves the contract with Gretchen Bernabie to provide training for writing teachers district wide for the 2010-2011 school year.

Rationale:

Gretchen Bernabie's trainings are specifically designed to familiarize teachers with research-based strategies that are designed to help even the most reluctant writers blossom into self-confident writers with their own voices. She will show teachers practical lessons that incorporate the best of what we know about kids, applied theory, and high scoring papers. Teachers will gain a better understanding of writing tests, a deeper working knowledge of the rubric, and a variety of engaging lessons that their students will actually like and are satisfying to teach.

Gretchen Bernabie is a sole source of this training and no other company or firm in the United States of America sells or distributes the products being purchased. Additionally, there is no like item(s) or products available for purchase that would serve the same purpose or function and there is only one price for the name items or products because of exclusive distribution or marketing rights.

This contract was negotiated by Elizabeth S. Perez, Secondary Language Arts Specialist.

Connections to the District Plan: of Student Achievement: Academic Goal 1: Academic Excellence -ECISD shall provide a diversified and innovative curriculum that focuses on comprehension, critical and creative thinking, application and problem solving for all students to achieve commended performance, Objective I. ECISD will offer all students a challenging high quality curriculum and will provide an effective delivery system to ensure *that all students will achieve and meet the District's Performance Objective Standards on the math, reading, writing and/or English language arts, science and social studies sections of the spring 2011 TAKS administration.

Paperwork Impact:

No additional paperwork will be generated.

Budgetary Information:

5 days training for writing teachers@ 2,500 for each day\$12,500.00

Account	Appropriation	Encumbrance	Expenditure	Balance
211-13-6291-00-999-130000	364,010.00	38,750.00	22,224.95	303,035.05

Resource Personnel:

Dr. René Gutiérrez, Superintendent of Schools
 Maria Luisa Guerra, Assistant Superintendent for Instruction and Support Services
 Elizabeth S. Perez, Secondary Language Arts Specialist
 Ronaldo Cavazos, Director of Federal Programs

Board Policy Reference and Compliance:

This is in accordance with Board Policy EEL (Legal): Contracting for Instruction With Outside Agencies and CH Purchasing and Acquisitions.

Prepared by:

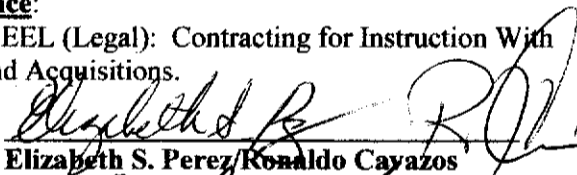
 11/8/10
 Elizabeth S. Perez/Ronaldo Cavazos

Approved by:

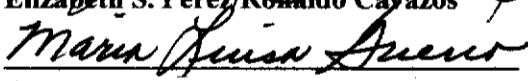
 Maria Luisa Guerra

Within Budgetary Allocation:

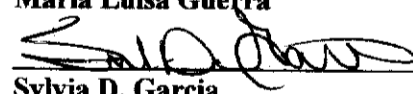
 Sylvia D. Garcia

Finance Department Approval:

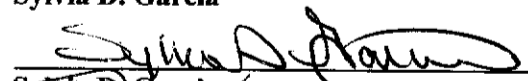
 Sylvia D. Garcia

Recommended by:

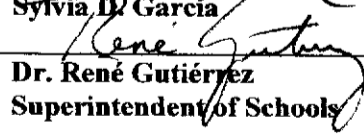
 Dr. René Gutiérrez
 Superintendent of Schools

CONTRACTED SERVICE AGREEMENT

This Contract/Agreement is made and entered into by and between Edinburg CISD, and Gretchen Bernabei referred to herein as "Contractor". The parties have severally and collectively agreed and by the execution hereof are bound to the mutual obligations and to the performance and accomplishment of the tasks hereinafter described.

Contractor shall provide professional services, consultation, and expertise for use and benefit to Edinburg Consolidated Independent School District.

Agency shall pay contractor a fee of \$ 12,500 for services and related expenses.*

Approved and accepted by Contractor this 3 day of November 2010.

Gretchen Bernabei
Contractor's Signature

Contractor's Name: Gretchen Bernabei

Address: 1111 Mt. Rainier Dr, City: San Antonio, State: TX Zip Code: 78213

Social Security: _____ Contract Period From: Dec. 4, 2010 June 15, 2011 (5 training days)

Scope of Work: Will show teachers practical lessons that incorporate the best of what we know about kids, applied theory, and high scoring payers.

Amount of Fee: 12,500

Funding Account Number: 211-13-6291-00-999-130000

Contracted Services must be approved 14 days prior of work. A Purchase Order must also be attached. By approval, the supervisor certifies the need for contract services and that sufficient funds are available. The supervisor will also monitor the contracted services. Invoices is required for payment. Invoice must be received in the Business Office by Monday in order to get paid by Friday of that week. Also, a W-9 is required if not already on file for payment.

FOR CONTRACTS OVER \$10,000

Termination of Contract: Contractor shall have completed all work covered by this contract and this contract shall terminate unless extended by mutual agreement of the district and the contracted services at the time final service is completed as indicated in paragraph 2 herein. This contract may be terminated by the District if for any reason the Contractor shall fail to fulfill in a timely and proper manner his obligation under this contract, in which event the district may terminate the contract by giving written notice of such termination and the effective date of the termination. In the event of termination prior to completion of the contract, the Contractor shall be entitled to receive just and equitable compensation for any satisfactory work completed to the date of termination. The District may also terminate this contract at any time without cause by the furnishing of a five day written notice from the Senior Financial Administrator to the Contractor, but the contractor will be paid an amount which bears the same ratio to the total compensation as the services actually performed to the total services of this contract, less any compensation previously paid.

	<u>Approved</u>	<u>Not Approved</u>	<u>Signature/Date</u>
Supervisor	_____	_____	_____
Administrative Assistant	_____	_____	_____
Superintendent/Designee	_____	_____	_____

*Contracted Services totaling over \$5000.00 require prior board approval.

Non-discrimination Statement

It is the policy of Edinburg CISD not to discriminate on the basis of sex, age, handicap, religion, race, color, or national origin in its educational programs.

White - Vendor

Yellow - Originator

Pink - Accounts Payable

EXHIBIT _____

Proposal for Services

To be delivered by:

Gretchen Bernabei
Trail of Breadcrumbs, LLC
1111 Mt. Rainier Dr.
San Antonio, TX 78213
email: bernabei@aol.com
Cell: 210-216-2265

To be contracted by:

Edinburg CISD
Contact person: Elizabeth Perez

Workshops to be delivered:

December 4, 2010 – Writing workshop to be conducted for teachers preparing students to write high-scoring essays on the TAKS assessment. ECISD may choose to use a modeling construct, with direct instruction to students while teachers interact.

June 13, 14, 15, 16, 2011 – Writing workshops to be conducted with teachers, using a modeling construct to prepare students to write high-scoring essays on the new Texas assessment program, the STAAR. This training will specifically address expository essays.

Fees:

Fees are \$2,500 per day for five days, totaling \$12,500. This will include travel and other expenses.

The school district will provide an overhead projector (either document camera or transparency style) and screens large enough for all participants to see; microphone; handouts, the masters of which to be provided by the presenter prior to the date of the workshop.

EXHIBIT _____

Edinburg Consolidated Independent School District
Sole Source Affidavit

RESET FORM

BEFORE ME, the undersigned official, on this day, personally appeared _____
A person known to me to be the person whose signature appears below, who after being duly
sworn upon his oath deposed and said:

1. My name is Gretchen Bernabei I am over the age of 18, have never been convicted of a crime and am competent to sign this affidavit.
2. I am an authorized representative of the following company or firm:
TRAIL OF BREADCRUMBS, LLC
3. The above named company or firm is the sole source of the following item(s) or product(s): (Attach list if necessary)
"Reviving the Essay" workshop for teachers, presented by the author of Reviving the Essay by Gretchen Bernabei.
4. Competition in providing the above named item(s) is precluded by the existence of a patent, copyright, secret process or monopoly.
5. There is/are no other like item(s) or product(s) available for purchase that would serve the same purpose or function and there is only one price for the above named item(s) or product(s) because of exclusive distribution or marketing rights.
6. We certify that no suspension or debarment is in place, which would preclude receiving a federally funded contract.

Gretchen S Bernabei
(Signature)

SUBSCRIBED AND SWORN to before me on this 19 day of January, 2012

(Seal)

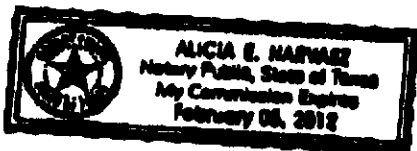

Alicia E Narvaez
(Notary Public, State of Texas)

ALICIA E NARVAEZ
(Printed Name)

2/5/2012
(Date Commission Expires)

Company Name: TRAIL OF BREADCRUMBS, LLC

Address: 1111 Mt. Rainier Dr.

City, State, Zip: San Antonio, TX 78213

Telephone: 210-216-2265 Fax: _____

Contact Person: Gretchen Bernabei Email: bernabei@aol.com

EXHIBIT _____

SOLE SOURCE MEMORANDUM

DATE: 11/4/2010
TO: Assistant Superintendent for Finance & Operations
FROM: Elizabeth S. Perez CAMPUS: Administration
SUBJECT: SOLE SOURCE AFFIDAVIT FOR Gretchen Bernabie
(Name of Vendor)

PURCHASE AMOUNT: \$ 12,500.00 REQUISITION NO: _____

DESCRIPTION OF ITEMS OR SERVICE: (Attach additional documentation, if necessary)

Ms. Bernabie will show teachers practical lessons that incorporate the best of what we know about kids, applied theory, and high scoring papers.

I have contacted a sufficient number of vendors to determine that only one practical source of supply exists. I have initialed the reason(s) why only one source of supply exists and stated it below:

- **There is no competitive or similar product.**
The good/service is a one-of-a-kind or patented product, a copyrighted publication available from only one source, or a unique item such as an art work.
- **The product is only available from a regulated or natural monopoly.** For example, utilities, gravel from the only pit in the area or some similar situation.
- **The product is a component of an existing system which is only available from one supplier.** The replacement of a component or a repair part is only available from the original supplier.
- **The item is produced by non-profit corporations using handicapped workers.** Products made by blind or otherwise handicapped workers are often used by schools, cities, and counties.
- **The item is produced by prison workers.** The state benefits from the sale of these items.
- **There are no other items available in the marketplace that have the same fit, form and function of the items being purchased.**

Elizabeth S. Perez 11/4/10
Signature Date

(Instructions: Campuses & Departments are required to complete this form and attach it to your sole source vendor affidavit. Fax or route all documents, such as Agenda Items, sole source affidavit, sole source memorandum to the Office of Assistant Superintendent for Finance & Operations.)

EXHIBIT _____

APPROVAL OF GODIRECT 11-58, SERVERS AND STORAGE AREA NETWORK (SAN) FOR THE TECHNOLOGY DEPARTMENT

Superintendent's Recommendation

That the Board of Trustees approve the recommendation to accept the GoDirect quote for servers and storage as requested by the Technology Department which is indicated in the attached as being the most favorable and advantageous to the District.

Rationale

The three (3) servers and Storage Area Network (SAN) will be used to consolidate software applications currently being used throughout the district. These applications will consist of the following: ECISD Online Learning Plan, Online District/Campus Improvement Plan, Exchange Outlook E-mail Database, Purchasing Department File Storage, Gifted & Talented Database, SNAP, and General SQL Server Database for additional storage requests.

Servers and storage purchased through the State of Texas Department of Information Resources meet all the bidding requirements. The State of Texas has awarded Dell a contract which is available to the District.

The DIR program was established under Chapter 2054, Texas Education Code. DIR is a cooperative contracts program that provides a channel for procurement of Information Technology Resources. It enables government entities to pool their purchasing power to drive down IT costs. http://www.dir.state.tx.us/dir_overview/index.htm

User Department

This item was requested by Eduardo J. Moreno, Technology Department.

Budgetary Information

Account	Description	Appropriations	Encumbrance	Expenditure	Balance
199-11-6397-52-889-111-045	FIXED ASSETS	112,000.00	0.00	0.00	112,000.00
	TOTAL	112,000.00	0.00	0.00	112,000.00

Resource Personnel

Dr. René Gutiérrez
 Sylvia D. Garcia
 Mario Salinas

Eduardo J. Moreno
 Amaro Tijerina
 Claudina E. Longoria

Board Policy Reference

This is in accordance with the Board Policy CH, Purchasing Law Bidding Requirements.

Requested by: Eduardo J. Moreno
 Eduardo J. Moreno, Director of Technology

Approved by: Mario Salinas
 Mario Salinas, Asst. Supt. of District Administration

Within Budgetary Allocations: Sylvia D. Garcia
 Sylvia D. Garcia, Director of Finance

Approved by: Sylvia D. Garcia
 Sylvia D. Garcia, Director of Finance

Recommended by: René Gutiérrez
 Dr. René Gutiérrez, Superintendent of Schools

EXHIBIT _____, PAGE(S) _____

11-13-10 10:37 AM M

Notes for
GoDirect 11-58, Servers and Storage Area Network for Technology Department
November 30, 2010

1. **USER DEPARTMENT:** This GoDirect quote was requested by the Technology Department. Eduardo J. Moreno will be present to answer any detailed questions regarding this quote.
2. **TYPE OF QUOTE:** This is a single time purchase.
3. **ORDERING INFORMATION:** Technology will prepare purchase orders following the Board of Trustees approval.
4. **APPROXIMATE AMOUNT SPENT LAST YEAR:** No servers or storage purchased last year.
5. **TOTAL ESTIMATED AWARD RECOMMENDATION:**

VENDOR	ESTIMATED AWARD AMOUNT
Dell 1 Dell Way Road Round Rock, TX 78682 CONTACT: Tasha Myers	(servers) \$17,743.50 (storage)+ <u>\$49,061.71</u>
TOTAL ESTIMATED AWARD	\$66,805.21

EXHIBIT _____



QUOTATION

QUOTE #: 561087581

Customer #: 108980332

Contract #: 48ABO

Customer Agreement #: DIR-SDD-890-TX

Quote Date: 10/21/10

Date: 10/21/10 9:01:25 AM

Customer Name: EDINBURG C I S D

TOTAL QUOTE AMOUNT:	\$17,743.50		
Product Subtotal:	\$17,743.50		
Tax:	\$0.00		
Shipping & Handling:	\$0.00		
Shipping Method:	Ground	Total Number of System Groups:	1

GROUP: 1	QUANTITY: 3	SYSTEM PRICE: \$5,914.50	GROUP TOTAL: \$17,743.50
-----------------	--------------------	---------------------------------	---------------------------------

Base Unit:	PE R710 with Chassis for Up to 8, 2.5-Inch Hard Drives and Intel 56XX Processors (224-8461)
Processor:	PowerEdge R710 Shipping (330-4124)
Memory:	24GB Memory (6x4GB), 1333MHz Dual Ranked RDIMMs for 2 Processors, Optimized (317-7299)
Monitor:	Embedded Broadcom, GB Ethernet NICS with TOE and iSCSI Offload Enabled (430-2970)
Monitor:	Embedded Broadcom, GB Ethernet NICS with TOE (430-1764)
Video Card:	Intel Xeon E5620 2.4Ghz, 12M Cache, Turbo, HT, 1066MHz Max Mem (317-4112)
Video Memory:	Intel Xeon E5620 2.4Ghz, 12M Cache, Turbo, HT, 1066MHz Max Mem (317-4124)
Video Memory:	PowerEdge R710 Heat Sinks for 2 Processors (317-1213)
Hard Drive:	HD Multi-Select (341-4158)
Hard Drive Controller:	PERC H700 Integrated RAID Controller, 512MB Cache, x8 (342-0648)
Floppy Disk Drive:	Power Saving BIOS Setting (330-3491)
Operating System:	No Operating System (420-6320)
NIC:	Broadcom 5709 Dual Port 1GbE NIC w/TOE iSCSI, PCIe-4 (430-3260)
Modem:	iDRAC6 Express (467-8649)
CD-ROM or DVD-ROM Drive:	DVD+/-RW, SATA, INTERNAL (313-9090)
Sound Card:	Bezel (313-7517)
Speakers:	Riser with 2 PCIe x8 + 2 PCIe x4 Slot (320-7886)
Documentation Diskette:	Dell Management Console (330-5280)
Documentation Diskette:	Electronic System Documentation and OpenManage DVD Kit (330-3485)
Feature:	RAID 10 for H700 or PERC 6/i Controllers (341-8701)
Feature:	Sliding Ready Rails Without Cable Management Arm (330-3478)
Service:	Dell Hardware Limited Warranty Extended Year (993-8458)
Service:	Dell Hardware Limited Warranty Plus On Site Service Initial Year (993-8447)
Service:	Pro Support for End User: Next Business Day Onsite Service After Problem Diagnosis, 2Year Extended (992-8262)
Service:	Pro Support for End User: Next Business Day Onsite Service After Problem Diagnosis, Initial Year (993-2300)
Service:	ProSupport for End Users: 7x24 HW / SW Tech Support and Assistance for End Users, 3 Year (992-8332)
Service:	Thank you choosing Dell ProSupport. For tech support, visit http://support.dell.com/ProSupport or call 1-800-9 (989-3439)
Extended Service:	Dell Proactive Systems Management - visit www.dell.com/Proactive to configure your service (909-0269)
Installation:	On-Site Installation Declined (900-9997)
Misc:	High Output Power Supply Redundant, 870W (330-3475)
Misc:	No Power Cord (310-9057)
	Power Cord, NEMA 5-15P to C13, 15 amp, wall plug, 10 feet / 3 meter (310-8509)
	Power Cord, NEMA 5-15P to C13, 15 amp, wall plug, 10 feet / 3 meter (310-8509)
	Power Cord, NEMA 5-15P to C13, 15 amp, wall plug, 10 feet / 3 meter (310-8509)
	146GB 10K RPM SA SCSI 6Gbps 2.5in Hotplug Hard Drive (342-2014)
	146GB 10K RPM SA SCSI 6Gbps 2.5in Hotplug Hard Drive (342-2014)
	146GB 10K RPM SA SCSI 6Gbps 2.5in Hotplug Hard Drive (342-2014)
	146GB 10K RPM SA SCSI 6Gbps 2.5in Hotplug Hard Drive (342-2014)
	146GB 10K RPM SA SCSI 6Gbps 2.5in Hotplug Hard Drive (342-2014)

SALES REP:	TASHA MYERS	PHONE:	1888-977-3355
Email Address:	Tasha_Myers@Dell.com	Phone Ext:	513-9362

EXHIBIT _____



QUOTATION

QUOTE #: 563426839
Customer #: 56076171
Contract #: 48ABO
Customer Agreement #: DIR-SDD-890-TX
Quote Date: 11/11/10

Date: 11/11/10 10:51:49 AM

Customer Name: EDINBURG C I S D

TOTAL QUOTE AMOUNT:	\$49,061.71		
Product Subtotal:	\$49,061.71		
Tax:	\$0.00		
Shipping & Handling:	\$0.00		
Shipping Method:	Ground	Total Number of System Groups:	3

GROUP: 1	QUANTITY: 1	SYSTEM PRICE: \$45,372.94	GROUP TOTAL: \$45,372.94
Base Unit:	Dell EqualLogic PS6000X, Mainstream Performance 10K SAS Drives (224-6601)		
Processor:	9.6 Terabyte capacity, 16 X 600GB, 10K SAS, Dual Controller, PS6000X (341-9660)		
Factory Installed Software:	Asynchronous Replication (468-7110)		
Software Disk Two:	Snaps/Clones with integration for MS SQL, Exchange, Hyper V and VMware (468-7155)		
Feature:	SAN HQ multi group monitoring software (468-7156)		
Service:	Thank you choosing Dell ProSupport. For tech support, visit http://support.dell.com/ProSupport or call 1-800-9 (989-3439)		
Service:	Mission Critical Package: 4-Hour 7x24 On-Site Service with Emergency Dispatch, 3 Year Extended (989-8403)		
Service:	ProSupport : 7x24 HW / SW Tech Support and Assistance , 4 Year (989-8513)		
Service:	Mission Critical Package: 4-Hour 7x24 On-Site Service with Emergency Dispatch, Initial Year (993-5430)		
Service:	MISSION CRITICAL PACKAGE: Enhanced Services, 4 Year (994-0169)		
Service:	Dell Hardware Limited Warranty Extended Year (994-0198)		
Service:	Dell Hardware Limited Warranty Initial Year (994-0227)		
Service:	EqualLogic Advanced Software Warranty and Service, 7x24 Access, 4 Year (994-0427)		
Installation:	Installation and Implementation of EqualLogic Storage Array, up to 2 Hosts (931-0809)		
Support:	Proactive Maintenance Service, EQL, 1 Event per yr, 1 yr (926-2989)		

GROUP: 2	QUANTITY: 1	SYSTEM PRICE: \$1,544.40	GROUP TOTAL: \$1,544.40
Base Unit:	PowerConnect 6248, 48 GbE PortManaged Switch, 10GbE and Stacking Capable (222-6714)		
Service:	Basic Enterprise Support: Business Hours (5X10) Next Business Day Parts Delivery 3YR Ext (960-6393)		
Service:	Basic Enterprise Support: Business Hours (5X10) Next Business Day Parts Delivery InitialYR (981-1240)		
Service:	Dell Hardware Warranty InitialYR (985-6027)		
Service:	Dell Hardware Warranty, Extended Year(s) (985-6038)		
Installation:	On-Site Installation Declined (950-8997)		

GROUP: 3	QUANTITY: 1	SYSTEM PRICE: \$1,544.40	GROUP TOTAL: \$1,544.40
Base Unit:	PowerConnect 6248, 48 GbE PortManaged Switch, 10GbE and Stacking Capable (222-6714)		
Service:	Basic Enterprise Support: Business Hours (5X10) Next Business Day Parts Delivery 3YR Ext (960-6393)		
Service:	Basic Enterprise Support: Business Hours (5X10) Next Business Day Parts Delivery InitialYR (981-1240)		
Service:	Dell Hardware Warranty InitialYR (985-6027)		
Service:	Dell Hardware Warranty, Extended Year(s) (985-6038)		
Installation:	On-Site Installation Declined (950-8997)		

SOFTWARE & ACCESSORIES			
Product	Quantity	Unit Price	Total
Stacking Module, 48Gbps Includes 1m Stacking Cable Customer Kit (320-5171)	1	\$179.99	\$179.99
RPS-600, Redundant Power Supply for PowerConnect (Supports 4 units), Customer Install (310-1803)	1	\$239.99	\$239.99

EXHIBIT _____

Stacking Module, 48Gbps Includes 1m Stacking Cable Customer Kit (320-5171)	1	\$179.99	\$179.99
Dell Education Services - No Training Requested - visit www.Learndell.com (994-3849)	1	\$0.00	\$0.00
Number of S & A Items: 4		S&A Total Amount: \$599.97	

SALES REP: TASHA MYERS	PHONE: 1888-977-3355
Email Address: Tasha_Myers@Dell.com	Phone Ext: 513-9362

Please review this quote carefully. If complete and accurate, you may place your order online at www.dell.com/qto (use quote number above). POs and payments should be made to *Dell Marketing L.P.*

If you do not have a separate agreement with Dell that applies to your order, please refer to www.dell.com/terms as follows:

If purchasing for your internal use, your order will be subject to *Dell's Terms and Conditions of Sale-Direct* including Dell's U.S. Return Policy, at www.dell.com/returnpolicy#total. If purchasing for resale, your order will be subject to *Dell's Terms and Condition of Sale for Persons or Entities Purchasing to Resell*, and other terms of Dell's PartnerDirect program at www.dell.com/partner. If your order includes services, visit www.dell.com/servicecontracts for service descriptions and terms.

Quote information is valid for U.S. customers and U.S. addresses only, and is subject to change. Sales tax on products shipped is based on "Ship To" address, and for downloads is based on "Bill To" address. Please indicate any tax-exempt status on your PO, and fax your exemption certificate, with seller listed as *Dell Marketing L.P.*, to Dell's Tax Department at 800-433-9023. Please include your Customer Number.

For certain products shipped to end-users in California, a State Environmental Fee will be applied. For Asset Recovery/Recycling Services, visit www.dell.com/assetrecovery.

EXHIBIT _____

APPROVAL TO PURCHASE UPDATED COURSEWARE AND SERVICES FROM PLATO LEARNING FOR EDINBURG HIGH SCHOOL, EDINBURG NORTH HIGH SCHOOL, ECONOMEDES HIGH SCHOOL AND EDINBURG ALTERNATIVE EDUCATION ACADEMY

Superintendent's Recommendation

That the Board of Trustees give approval to purchase updated courseware and services from PLATO Learning for Edinburg High School, Edinburg North High School, Economedes High School and Edinburg Alternative Education Academy.

Rationale

The Federal Programs Department is requesting approval to update the current PLATO Learning licenses at all 3 high schools as well as the Edinburg Alternative Education Academy to a web-based program. PLATO is used by students for credit recovery and acceleration. This purchase would upgrade this system and expand the number of courses currently available to students. Training days for this software are also included in this request. This purchase will standardize the contract start and end dates. This purchase meets purchasing law compliance and is a sole source.

Connections to the District Plan: Goal Area 3 - Technology

District Performance Objective IV

Initiative III: Ensure accessibility by all students and staff to technology-based instruction, to adaptive/assistive devices and Internet/network resources as appropriate.

Paperwork Impact

Minimal

Budgetary Information

		Total Purchase			172,285.00
Account	Description	Appro.	Enc..	Exp.	Balance
161-11-6399-75-xxx-130000	General Supplies	163,285.00	0	0	163,285.00
161-11-6219-75-xxx-130000	Other Prof. Services	9,000.00	0	0	9,000.00

Resource Personnel

- Dr. René Gutiérrez, Superintendent of Schools
- Maria Luisa Guerra, Assistant Superintendent for Instruction and Support Services
- Ronaldo J. Cavazos, Director for Federal Programs
- Santa Alvarado, Area Director
- Dominga Vela, Area Director
- Hector Gonzalez, Area Director
- Gladys Ortega, Bilingual/ESL Director

Board Policy Reference and Compliance

This item is in accordance with Board Policy CH (Local) Purchasing and Acquisitions.

Requested by:

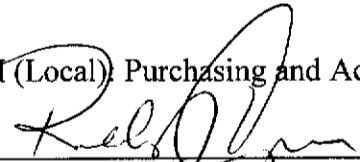

 Ronaldo J. Cavazos

Approved by:

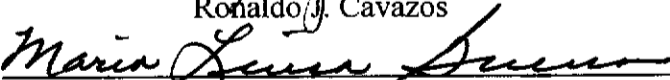

 Maria Luisa Guerra

Within Budgetary Allocation:

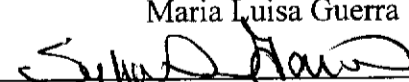

 Sylvia D. Garcia

Finance Department Approval:

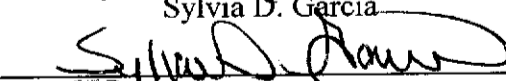

 Sylvia D. Garcia

Recommended by:

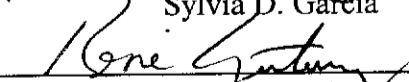

 Dr. René Gutiérrez
 Superintendent of Schools

➔ EXHIBIT _____, PAGES _____



Sole Source of PLATO Products

PLATO, Inc. dba PLATO Learning ("PLATO") develops, markets, sells, and supports a broad portfolio of educational curriculum, assessment, correlation, management, and resource products and associated services, which are more fully identified and described at www.plato.com. These educational products and services have been proven successful in fostering academic achievement throughout the K-12, higher education, and adult education markets.

PLATO owns or has exclusive rights to all "PLATO Products," meaning all products marketed by PLATO except: (a) products produced by Rosetta Stone Ltd. and WorldView Software, Inc. and marketed under their own trade names by PLATO, and (b) a limited number of assessment questions integrated into PLATO assessment products.

PLATO Products were developed at private expense. They are protected by intellectual property rights, including copyrights, trademarks, patents and trade secrets, which are either owned by PLATO and/or exclusively licensed to PLATO by third parties (the "IP Rights"). The PLATO Products and the IP Rights shall at all times remain the property of PLATO and/or its exclusive licensors. The PLATO Products are licensed, not sold, and the Licensee's rights of access to and use of these products shall be as defined in the applicable PLATO license agreement. Trade secrets of PLATO and its licensors are trade secrets for all purposes, including for the purposes of the Freedom of Information Act.

PLATO distributes certain PLATO Products through non-profit school buying consortia and resellers serving eligible member school districts and institutions in parts of California, Michigan and Texas. Otherwise:

PLATO has the exclusive right to make, use, sell, distribute, and market the PLATO Products and is the sole source and sole provider of the PLATO Products. The PLATO Products are not available for purchase, leasing, licensing, rent or distribution, directly or indirectly, as an application suite from any OEM, reseller, or any other third party.

With sincere thanks for your business,

A handwritten signature in black ink, appearing to read "Mitchell Wacker".

Mitchell Wacker

Director, Customer Finance & Fulfillment

PLATO Learning, Inc., 10801 Nesbitt Avenue South, Bloomington, MN 55437-3109

→EXHIBIT _____

ORDER FORM

PLATO, Inc. dba PLATO Learning
 ("PLATO Learning")
 5600 W 83rd Street
 8200 Tower, Suite 300
 Bloomington, MN 55437
 Fax: 952.229.3810

DATE: 10/07/10
 ORDER NO: 02281281- REVISION NO: 0

Customer and Billing Address

Customer No: 4610061100
 Customer Name: EDINBURG CONSOLIDATED I S D ("Customer")
 Billing Address: 411 North 8th Avenue PO Box 990
 Edinburg, TX, 78540

(For the purposes of this Order Form, "You" and "Your" refer to Customer, and "We", "Us" and "Our" refer to PLATO Learning.)

Products and Services:

Description	License Type*	License Period	Term		Units	Price per Unit	Total Price
			Start Date	End Date			
Secondary Academic Library Student	S	12 Months	4/20/2011	4/19/2012	227	\$600.00	\$136,200.00
Secondary Academic Library Student	S	13 Months	4/1/2011	4/19/2012	18	\$650.00	\$11,700.00
Secondary Academic Library Student	S	17 Months	11/28/2010	4/19/2012	10	\$850.00	\$8,500.00
Test Pack Student TEXAS	S	12 Months	4/20/2011	4/19/2012	6	\$1,147.50	\$6,885.00
Coaching (6 hour session) Services Delivery: Year 1	N/A	N/A	***	***	5	\$1,800.00	\$9,000.00
Subtotal:							\$172,285.00
Sales tax:							\$0.00



ORDER FORM

PLATO, Inc. dba PLATO Learning
("PLATO Learning")
5600 W 83rd Street
8200 Tower, Suite 300
Bloomington, MN 55437
Fax: 952.229.3810

DATE: 10/07/10
ORDER NO: 02281281- REVISION NO: 0

Total US Funds:	\$172,285.00
<p>* "S" = Subscription License; "P" = Perpetual License. See Our Standard License and Purchase Terms at www.plato.com/StandardTerms&L28 for a full description of Your software licensing rights and obligations.</p> <p>**Unless otherwise specified in this Order Form, the Start Date for your license(s) will be (a) for a renewal, the day following expiration of the prior license term; (b) for a new subscription order, 30 days after receipt and acceptance of the signed Order Form; and (c) for a perpetual license, upon receipt of Your signed Order Form. Promptly after We have accepted Your signed Order Form, We will confirm to You the applicable Start Date for Your software license(s).</p> <p>*** Services are purchased on an annual term. Any service offering that is not used during the applicable year, may not be carried over or used in subsequent years.</p>	

Invoicing and Payment Terms:

The full amount of Your Order will be invoiced when accepted by Us. Payment is due 15 days after invoice date.

Acknowledgements:

System Requirements: If Your order includes software products, You acknowledge that You have read and understand the System Requirements Documents (available at <http://support.plato.com/requirements.asp>) and that it is Your responsibility to fulfill them. The System Requirements Document details the minimum computer equipment, hardware, systems and systems configurations, network infrastructure, bandwidth and similar requirements needed to successfully access and use our software and also identifies certain system configurations, components or otherwise that will not function or fully function with our product and therefore cannot be used in connection with our product. You acknowledge that We retain the right to update the Requirement Documents from time to time and You agree to comply with them, as updated. You also confirm that all buildings and/or sites included in the scope of this SOW are in full compliance of the System Requirements Documents and that if You determine to make a modification that results in Your system including elements that are not specifically enumerated as being supported by Us in the Requirements Documents, You will first provide Us written notice and You accept and acknowledge that You might not be able to access or use or properly access or use our Products thereafter and any fees or costs associated with support that We might choose to make to address Your issues will be billed to You at our then standard rates and promptly payable by You.

If this Order Form includes Professional Services, they are described in the enclosed Statement of Work. The Statement of Work outlines Your roles and responsibilities in support of Our Professional Services and is critical to the successful delivery of these services. You acknowledge that You have read the Statement of Work and understand these roles and responsibilities.

Terms and Conditions:

Your purchase of licensing rights to software and/or professional services contained in this Order Form is subject to Our Standard Purchase and License Terms ("Standard Terms"), which can be found at www.plato.com/standardterms&L28. This Order Form and any documents it incorporates (including the Standard Terms and documents it references) form the entire agreement between You and Us about your purchase ("Agreement").

Purchase Order

v. 08I09

Page 2 of 8



→EXHIBIT _____

ORDER FORM

PLATO, Inc. dba PLATO Learning
("PLATO Learning")
5600 W 83rd Street
8200 Tower, Suite 300
Bloomington, MN 55437
Fax: 952.229.3810

DATE: 10/07/10
ORDER NO: 02281281- REVISION NO: 0

You acknowledge that this Agreement is non-cancellable and will submit a purchase order for the full amount of this Order Form. Your order will not be scheduled for delivery until You have submitted a purchase order referencing and conforming to this Order Form. You acknowledge that any terms and conditions in Your purchase order or any other documents You provide are superseded by the terms and conditions of this Agreement.

Acceptance:

We have presented this Order Form to You as an offer to contract under the terms and conditions of this Agreement, including the Standard Terms. Your signing and submitting this Order Form to Us will constitute Your acceptance to contract on these terms and conditions; this offer will expire 90 days after the Date noted above unless We earlier withdraw or extend the offer in writing. Please have Your authorized representative sign in the space below to accept this offer and confirm the Agreement between You and Us.

Customer Signature:	
Name (Printed or Typed):	
Title:	
Date:	



Exhibit A: Statement of Work



Statement of Work
PLATO Learning Professional Services

Order Number:	02281281
Date:	10/07/10
Prepared For:	EDINBURG CONSOLIDATED I S D
Customer Project Contact:	RONALDO CAVAZOS
Customer Project Contact Phone Number:	(956) 289-2300

PLATO, Inc.
5600 W 83rd Street
8200 Tower, Suite 300
Bloomington, MN 55437
Main: 952.832.1000
Fax: 952.229.3810



1 Overview and Purpose

PLATO, Inc. dba PLATO Learning (“PLATO Learning”, “We”, “Us” and “Our”) is pleased to provide this Statement of Work (“SOW”) to EDINBURG CONSOLIDATED I S D (“You” and “Your”). We appreciate the opportunity to provide Our Professional Services to You and look forward to contributing to Your success.

The purpose of this SOW is to define and communicate the goals, scope of services, work plan, milestones, and roles and responsibilities of each party as they relate to the Professional Services to be provided by Us to You. We have entered into this SOW with a mutual desire to enable Your successful implementation and use of the PLATO Learning solutions. Completion of this SOW is the first step to achieving these goals and is critical to maximizing the benefit of Our Professional Services.

2 Services Description

The Professional Services You have purchased from us to be implemented under this SOW are as follows:

Services Package	Units	Package Sessions					
		Strategy, Planning & Setup		Professional Development		Coaching and Follow-Up	
		Distance Upto 3 hrs.	Onsite Upto 6 hrs.	Onsite Day 1	Onsite Day 2	Distance Upto 3 hrs.	Onsite Upto 6 hrs.
Coaching (6 hour session), Services Delivery: Year 1	5						5

Unless specified elsewhere in this agreement, any multi year service offering that You purchase has to be used in the applicable year any may not be carried over or used in subsequent years.



3 Solution Description and Shared Program Focus Area

We are providing You the Professional Services identified in this SOW in order to assist You in the implementation of the following solutions:

PLATO Learning and EDINBURG CONSOLIDATED I S D agree to partner on the following program focus area(s)

4 Roles and Responsibilities

We commit to cooperating with You reasonably and in good faith in the performance of the Professional Services and You agree to do the same. If You do not, delays may result or You may not achieve the full benefits of our services. Other important roles and responsibilities are as follows:

We agree to provide:

- Certain PLATO personnel and agents, which may include an **implementation manager, a PLATO Learning consultant(s) or a Customer support specialist(s).**
- **The above personnel will, with Your assistance and dedication, strive to enhance You and Your teachers and students experience using PLATO product.**
- Certain **Training materials** to support the training regimen will be provided.

You agree to provide:

- **Administrative lead** empowered to make program and policy decisions associated with the implementation of the proposed PLATO Learning solution.
- **Technical lead** who can ensure access to the appropriate technology resources required to implement the solution; including technical resources required for successful training of Customer staff.
- **Instructional staff**, including Site Administrators, who will implement and monitor the solution with the targeted student population.
- **Training facilities**, suitably equipped to access the PLATO Learning software in accordance with the System Requirements.
- **Access to office workspace**, telephone, computer with Internet access, and other facilities as may be requested by the PLATO Learning consultant in the performance of the Professional Services.
- **Coordination of customer personnel** for onsite, online, and telephonic meetings.
- **Other resources** as reasonably required by the PLATO Learning consultant for satisfactory and timely performance of the Professional Services. Sufficient access to hardware and equipment necessary to provide adequate time-on-task for those learners selected to participate in the program.
- **Adequate time for staff professional development** to ensure the competence of Your staff in operating and implementing the solution.
- **Coaching and follow up opportunities** for Your staff to enhance implementation of the solution.



5 Confidentiality

You agree to keep the information, materials, logins, passwords, data, documentation or similar (the "Information") that we provide you in connection with the services hereunder confidential and take all reasonable steps to ensure that the Information is only disclosed to Your teacher or Your students as appropriate and is not disclosed to or made accessible to third parties. Upon notice of termination or expiration, send back all materials, passwords, software and anything else You receive in connection with Your license and ensure that neither Your teacher, students nor anyone else that You supplied access to Our products attempts to access Our product.

6 Project Duration and Scheduling

Unless otherwise agreed to by You and Us in writing, Professional Services will be scheduled within 30 days of our receipt of the signed Order Form. We will work with You to identify dates for conducting the Professional Services outlined in this SOW. Subsequent scheduling changes requested by You may result in additional fees. If You need to change previously agreed-upon dates, You agree to provide Us no less than five (5) business days advance notice of a cancellation of an onsite Professional Services session or three (3) business days advance notice of a cancellation of a virtual Professional Services session. If You do not provide such notice, and we have not been able to re-assign PLATO Learning consultants assigned to You, or we incur additional expense or efforts, You may be responsible for additional charges.

7 Implementation Considerations

Size of Implementation	{Indicate the type of purchase, such as: Alternative Schools, Corrections, District Level, Purchase, Elementary Schools, High Schools, Middle/Jr. High Schools, Post-Secondary Institution, Statewide, Other}
Technology Access	Labs

8 Implementation Methodology

The following timeline adheres to the phases of implementation outlined in a typical PLATO Learning Services Model. It serves as the foundation for the success of PLATO Learning Professional Services, defining the "process" in the delivery of on-site training and/or effective eLearning solutions, while providing sound instructional methods and sustaining measurable results through highly qualified professional development.

Strategy, Planning, and Setup	Plan	Implementation Launch and Planning Meeting
Professional Development	Instruct	Initial Training on the PLATO® Solution
Coaching & Follow Up	Follow Up	Coaching & Follow Up, Implementation Support, Process Integration, and Implementation Review

9 Acknowledgement

By signing the PLATO Learning Order Form, You agree to the statements, terms, responsibilities, and Professional Services plans as cited within this Statement of Work.



Installation/User Site Information

Description	Installation/User Site	
Secondary Academic Library	EDINBURG CONSOLIDATED I S D	18
Secondary Academic Library	EDINBURG CONSOLIDATED I S D	10
Test Pack	EDINBURG NORTH HIGH SCHOOL	1
	EDINBURG HIGH SCHOOL	1
	ECONOMEDES HIGH SCHOOL	1
	EDINBURG ALTERNATIVE ACADEMY	1
	JUVENILE DETENTION CENTER	1
	Vision Academy	1
Coaching (6 hour session)	EDINBURG CONSOLIDATED I S D	5

v. 08I09

Page 8 of 8



→EXHIBIT _____

PLATO Learning K-12 Instructional Content on PLE™



■ Every learner deserves a chance to succeed

PLATO Learning knows that inside every student is a success story waiting to happen. Give every learner the opportunity to experience personal achievement with the best instruction technology has to offer:

- Quality, rigorous content, second to none
- Superior multimedia that attracts and captivates students
- Maximum, consistent, and replicable results

Make an informed choice. Do your homework and ask the right questions to ensure you're making your investment in students count.



PLATO
LEARNING

→EXHIBIT _____

Sustain continuous
integrating technology
the skills that

Content Titles on PLE™	Skill Level														Target Learners						
	K	1	2	3	4	5	6	7	8	9	10	11	12	13-14	E	M	H	PS			
Reading, Language Arts, and Writing																					
PLATO® Beginning Reading	██████████																				
PLATO® Essential Writing Process and Practice				██████████												✓	✓	✓			
PLATO® Essential Reading Skills			██████████													✓	✓	✓			
PLATO® Vocabulary and Reading Comprehension			████████████████████														✓	✓	✓		
PLATO® Reading Explorations				██████████												✓	✓	✓			
PLATO® Fundamental Reading Strategies					██████████											✓	✓	✓			
PLATO® Fundamental Writing Process and Practice					██████████											✓	✓	✓			
PLATO® Intermediate Reading Strategies							██████████									✓	✓	✓			
PLATO® Intermediate Writing Process and Practice							██████████									✓	✓	✓			
PLATO® Advanced Reading Strategies									██████████████████									✓	✓	✓	
PLATO® Advanced Writing Process and Practice										██████████									✓	✓	✓
Mathematics																					
Straight Curve® Mathematics	██████████████████																				
PLATO® Foundational Mathematics	██████████████																				
PLATO® Math Expeditions	██████████████████														✓	✓					
PLATO® Math Problem Solving			██████████████████														✓	✓	✓		
* PLATO® Data Skills for Today						██████████████████										✓	✓	✓			
PLATO® Algebra 1, Part 1						██████████										✓	✓	✓			
PLATO® Algebra 1, Part 2						██████████										✓	✓	✓			
PLATO® Algebra 2, Part 1						██████████										✓	✓	✓			
PLATO® Algebra 2, Part 2							██████████									✓	✓	✓			
PLATO® Geometry 1							██████████									✓	✓	✓			
PLATO® Geometry 2								██████████								✓	✓	✓			
PLATO® Consumer Mathematics									██████████								✓	✓	✓		
PLATO® Trigonometry Skills										██████████								✓	✓	✓	
Science																					
PLATO® Life Science							██████████										✓	✓	✓		
PLATO® Physical Science							██████████										✓	✓	✓		
PLATO® Earth and Space Science							██████████										✓	✓	✓		
PLATO® Technology Fundamentals							██████████										✓	✓	✓		
PLATO® Biology Series								██████████									✓	✓	✓		
PLATO® Chemistry Series								██████████									✓	✓	✓		
Social Studies																					
*WorldView® Civics							██████████										✓	✓	✓		
*WorldView® Basic American History I & II							██████████										✓	✓	✓		
*WorldView® African Global Studies							██████████										✓	✓	✓		
*WorldView® Latin American Global Studies							██████████										✓	✓	✓		
*WorldView® East Asia Global Studies							██████████										✓	✓	✓		
*WorldView® Middle East Global Studies							██████████										✓	✓	✓		
*WorldView® South & SE Asia Global Studies							██████████										✓	✓	✓		
*WorldView® Geography								██████████									✓	✓	✓		
*WorldView® U.S. Government									██████████								✓	✓	✓		
*WorldView® American History I & II									██████████								✓	✓	✓		
*WorldView® European History I & II									██████████								✓	✓	✓		
*WorldView® World History I-IV									██████████								✓	✓	✓		
*WorldView® Economics									██████████								✓	✓	✓		

→ EXHIBIT _____

"PLATO Learning gives us so much content in each course, we can match our scope and sequence to the product in any way we want...But, the single most important reason we chose PLATO was the students' excitement when interacting with the products."

—Shawn Williams, assistant principal, Alvin High School, Alvin ISD, Texas



Content Titles on PLE™	Skill Level														Target Learners			
	K	1	2	3	4	5	6	7	8	9	10	11	12	13-14	E	M	H	PS
Life and Career Skills																		
PLATO® Basic Skills for the Real World	[Shaded]														✓	✓		
PLATO® Projects for the Real World	[Shaded]														✓	✓		
PLATO® Informational Reading	[Shaded]														✓	✓	✓	✓
PLATO® Workplace Writing	[Shaded]														✓	✓	✓	✓
PLATO® Business Basics	[Shaded]														✓	✓	✓	✓
PLATO® Job Skills for the Real World	[Shaded]														✓	✓	✓	✓
PLATO® Communication Skills	[Shaded]														✓	✓		
Electives																		
PLATO® Health	[Shaded]														✓	✓		
PLATO® Computer Applications and Technology	[Shaded]														✓	✓		
PLATO® Art History and Appreciation	[Shaded]														✓	✓		
PLATO® Courses																		
English 7 A/B	[Shaded]														✓	✓		
English 8 A/B	[Shaded]														✓	✓		
English 9 A/B	[Shaded]														✓	✓		
English 10 A/B	[Shaded]														✓	✓		
English 11 A/B	[Shaded]														✓	✓		
English 12 A/B	[Shaded]														✓	✓		
Pre-Algebra A/B	[Shaded]														✓	✓		
Algebra 1 A/B	[Shaded]														✓	✓		
Algebra 2 A/B	[Shaded]														✓	✓		
Geometry A/B	[Shaded]														✓	✓		
Consumer Mathematics	[Shaded]														✓	✓		
Physical Science A/B	[Shaded]														✓	✓		
Life Science A/B	[Shaded]														✓	✓		
Biology A/B	[Shaded]														✓	✓		
Chemistry A/B	[Shaded]														✓	✓		
Basic American History 1 A/B	[Shaded]														✓	✓		
Basic American History 2 A/B	[Shaded]														✓	✓		
Civics A/B	[Shaded]														✓	✓		
American History 1 A/B	[Shaded]														✓	✓		
American History 2 A/B	[Shaded]														✓	✓		
Geography A/B	[Shaded]														✓	✓		
U.S. Government A/B	[Shaded]														✓	✓		
Economics A/B	[Shaded]														✓	✓		
World History A/B	[Shaded]														✓	✓		
Health	[Shaded]														✓	✓		
Computer Applications and Technology	[Shaded]														✓	✓		
Art History and Appreciation	[Shaded]														✓	✓		

*Third party product distributed by PLATO Learning.



...higher AP performance on the English Language, Biology, Calculus AB, and U.S. History Exams corresponded to higher FYGPAs [First Year Grade Point Averages], higher second-year retention rates, and attendance at more selective institutions

—The Relationship Between AP® Exam Performance and College Outcomes; College Board Research Report No. 2009-4

PLATO® AP® Edition Courses

Provide accelerated students the opportunity to enroll in rigorous, semester-long courses aligned to the College Board Advanced Placement® exams. PLATO AP Edition Courses deliver ongoing practice in skills and techniques—such as problem solving, critical thinking, and effective writing—that help drive success on the AP® Exam and in college.

Benefits

- High-quality, rigorous digital content that addresses 100% of standards defined by the College Board
- Relevant curriculum that challenges and engages students through interactive technology and multi-media in every lesson
- Research-based pedagogy that supports 21st Century skills with Internet-based activities that encourage critical thinking and analysis
- Collaborative learning that includes teacher-student and student-student interaction
- Depth of instruction—between 120–150 hours per semester course
- Minimized time for set-up—online curriculum and automated assessments and scoring

Key Elements

Course content—online instruction combined with Internet-based simulations, discussion topics, and culminating activities/labs form a comprehensive, rigorous curriculum that reflects the testing methods for AP Exams.

Assessments—unit pre-, post-, and end-of-semester tests report student performance against individual learning objectives. Mastery and unit assessments determine student proficiency for objectives within a unit.

Reporting—track student progress and class performance against course assignments while allowing teachers to determine if students are on pace or need support.

→ EXHIBIT _____

PLATO Learning Curriculum

SECONDARY ACADEMIC LIBRARY

MATH - Content Titles

Math Expeditions E – I
Foundational Math
Math Problem Solving
Algebra I, Part I
Algebra I, Part II
Geometry I
Geometry II
Algebra II, Part I
Algebra II, Part II
Consumer Mathematics
Trigonometry Skills
Miscellaneous Math Resources

MATH Courses

PLATO Course Pre-Algebra A/B
PLATO Course Algebra I A/B
PLATO Course Algebra IIA/B
PLATO Course Geometry A/B
PLATO Course Consumer Math
PLATO Course Advanced Calculus A/B

LANGUAGE ARTS - Content Titles

Reading Explorations F-G
Essential Reading Skills
Fundamental Reading Strategies
Intermediate Reading Strategies
Vocabulary and Reading Comprehension
Essential Writing Process/Practice
Fundamental Writing Process/Practice
Advance Reading Strategies
Intermediate Writing Process/Practice
Advance Writing Process/Practice
Informational Reading
Workplace Writing
Communication Skills
Miscellaneous Language Arts Resources

LANGUAGE ARTS Courses

PLATO Course English 7A/B
PLATO Course English 8A/B
PLATO Course English 9A/B
PLATO Course English 10A/B
PLATO Course English I I A/B
PLATO Course English 12A/B
PLATO Course Advanced English Literature A/B

SCIENCE - Content Titles

Earth and Space Science
Life Science
Physical Science
Biology
Chemistry
Technology Fundamentals

SCIENCE Courses

PLATO Course Life Science A/B
PLATO Course Physical Science A/B
PLATO Course Biology A/B
PLATO Course Chemistry A/B
PLATO Course Advanced Biology A/B

SOCIAL STUDIES - Content Titles

Basic American History I
Basic American History II
African Global Studies
Latin American Global Studies
East Asia Global Studies
Middle East Global Studies
South and Southeast Asia Global Studies
Civics
Geography
World History I
World History II
World History III
World History IV
Economics
American History I
American History II
European History I
European History II
US Government

SOCIAL STUDIES Courses

PLATO Course Basic Am History IA/B
PLATO Course Basic Am History IIA/B
PLATO Course Civics A/B
PLATO Course Geography A/B
PLATO Course American History IA/B
PLATO Course American History IIA/B
PLATO Course US Government A/B
PLATO Course Economics A/B
PLATO Course World History A/B

ELECTIVES/WORKPLACE - Content Titles

Art History and Appreciation
Computer Applications and Technology
Health
Business Basics
Basic Skills for the Real World
Job Skills for the Real World
Data Skills for Today

ELECTIVE Courses

PLATO Course Art History/Appreciation
PLATO Course Computer Applications/Technology
PLATO Course Health



APPROVAL OF INTERLOCAL AGREEMENT BETWEEN CITY OF McALLEN AND EDINBURG CISD FOR THE SAFE ROUTES TO SCHOOL PROJECT

Superintendent's Recommendation

That the Board of Trustees approves the Interlocal Agreement Between the City of McAllen and Edinburg CISD for the Safe Routes to School Project as prepared by Administration.

Rationale

The District and the City of McAllen were awarded the Safe Routes to School grant for one (1) campus within the City of McAllen limits totaling \$286,870. The City of McAllen is presently waiting on the Advance Funding Agreement (AFA) with TxDOT, but may proceed with the Interlocal to retain the Project Engineer.

Under this agreement, the District will pay the City of McAllen \$30,000 or 100% for the Engineer fees and 100% of any construction cost overruns that may occur. The Engineer fee will be 100% reimbursable.

The District will participate in the RFQ process having complete control of the Engineering Firm selected for the project. The City of McAllen will execute the contract for the Engineer.

The Facilities Committee has reviewed this item and recommended Board approval.

Budgetary Information

Account Number	Appropriation	Encumbrance	Expenditure	Balance
199-81-6216-00-xxx-199	\$ 3,500,000.00	\$0.00	\$0.00	\$ 3,500,000.00

Resource Personnel

Facilities Committee Dr. Rene Gutiérrez
 Mario Salinas Sylvia Garcia
 Robert Estrada

Board Policy Reference

This is in accordance with Board Policy BAA (Legal) Board Powers and Duties.

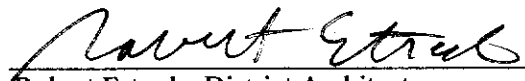
Prepared by: 
 Robert Estrada, District Architect

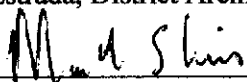
Approved by: 
 Mario Salinas, Asst. Superintendent for District Administration

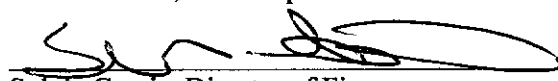
Within Budgetary Allocations: 
 Sylvia Garcia, Director of Finance

Recommended by: 
 Dr. Rene Gutierrez, Superintendent of Schools

Exhibit _____, Pages _____

ECISD SRYS DETAILED CONSTRUCTION COST ESTIMATE

NAME OF SCHOOL	ENGINEERING	ENVIRONMENTAL	CONSTRUCTION	CONSTRUCTION CONTINGENCIES	TOTAL
CITY OF EDINBURG					
Eisenhower Elem. / Memorial MS	50,000	10,000	370,000	65,000	495,000
Villarreal / Monte Cristo Elem.	40,000	10,000	380,760	65,000	495,760
De Zavala Elementary	40,000	10,000	381,900	65,000	496,900
Truman Elementary	40,000	10,000	382,870	65,000	497,870
Guerra Elementary	40,000	10,000	382,600	65,000	497,600
B.L. Garza Middle School	40,000	10,000	380,900	65,000	495,900
L.B. Johnson Elementary	40,000	10,000	381,480	65,000	496,480
Jefferson Elementary	40,000	10,000	381,480	65,000	496,480
Jose De Escandon Elementary	40,000	10,000	381,490	65,000	496,490
Cano-Gonzalez Elementary	40,000	10,000	378,960	65,000	493,960
Trevino Elementary	40,000	10,000	380,760	65,000	495,760
Harwell Middle School	40,000	10,000	382,560	65,000	497,560
Robert E. Lee Elementary	40,000	10,000	382,960	65,000	497,960
Freddy Gonzalez Elementary	40,000	10,000	382,560	65,000	497,560
Canterbury Elementary	40,000	10,000	380,470	65,000	495,470
South Middle School	40,000	10,000	380,470	65,000	495,470
Austin Elementary	50,000	10,000	372,650	65,000	497,650
Lincoln Elementary	50,000	10,000	369,875	65,000	494,875
Travis Elementary	50,000	10,000	373,360	65,000	494,875
De La Vina Elementary	40,000	10,000	382,560	65,000	497,560
TOTALS:	840,000	200,000	7,590,665	1,300,000	9,927,180
CITY OF EDINBURG COST:	420,000				
ECISD COST:	420,000				
CITY OF McALLEN					
Cavazos Elementary	30,000	10,000	286,870	65,000	376,870
TOTALS:	30,000	10,000	286,870	65,000	376,870
ECISD COST:	30,000				
HIDALGO COUNTY					
Carmen Avila Elementary	40,000	10,000	382,200	65,000	497,200
San Carlos / J.F. Kennedy Elem.	40,000	10,000	381,070	65,000	496,070
Esparza / Betts Elementary	50,000	10,000	371,360	65,000	496,360
TOTALS:	130,000	30,000	1,134,630	195,000	1,489,630
GRAND TOTAL:	1,000,000	240,000	9,012,165	1,560,000	11,793,680
ECISD GRAND TOTAL COST:	450,000				

EXHIBIT

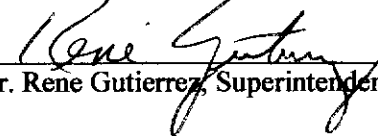
STATE OF TEXAS §

COUNTY OF HIDALGO §

**INTERLOCAL COOPERATION AGREEMENT
BETWEEN THE CITY OF MCALLEN AND THE
EDINBURG CONSOLIDATED INDEPENDENT SCHOOL DISTRICT**

This Agreement is made on this the ____ day of _____, 2010, by and between the **CITY OF MCALLEN** hereinafter referred to as "McAllen" and the **EDINBURG CONSOLIDATED INDEPENDENT SCHOOL DISTRICT, TEXAS**, hereinafter referred to as "ECISD," pursuant to the provisions of the Texas Interlocal Cooperation Act, as follows:

WITNESSETH:

WHEREAS, Edinburg Consolidated Independent School District through the City of McAllen applied for a Safe Routes to School Grant from the Texas Department of Transportation; and

WHEREAS, though Minute Order No. 112268 on May 27, 2010 City of McAllen was granted \$286,870.00 through the Safe Routes to School Program (SRTS) Fund for the construction of improvements to one campus located within the City of McAllen belonging to the District; and

WHEREAS, McAllen intends to enter into an Advance Funding Agreement (AFA) with the Texas Department of Transportation for funds which will include in addition to the above, Preliminary Engineering (PS&E), Environmental Assessment, Right of Way Acquisition, and Construction Contingency costs to be provided by the Texas Department of Transportation.

WHEREAS, McAllen has determined that it will receive benefit from the infrastructure improvements and has agreed to assist the ECISD; and

WHEREAS, the ECISD has determined that it will receive benefit from the infrastructure improvements and has agreed to assist McAllen; and

WHEREAS, ECISD and McAllen have agreed to cooperate in the improvements as further herein described; and

WHEREAS, ECISD and McAllen are authorized to enter into this Agreement pursuant to the Interlocal Cooperation Act, Texas Govt. Code 791.001 et seq., which authorizes local governments to contract with each other to perform governmental functions and services under the terms of the Act.

1

EXHIBIT _____

NOW, THEREFORE, ECISD and McAllen, in consideration of the mutual covenants expressed hereinafter, agree as follows:

1. The City of McAllen will serve as the lead agency; executing the Advanced Funding Agreement with the Texas Department of Transportation, coordinating the RFQ process for Preliminary Engineering (PS&E Development), Environmental Assessment, and by providing Right of Way Acquisition Services (if necessary) and providing submissions to the Texas Department of Transportation, as required by the Safe Routes to School (SRTS) Program;
2. The City of McAllen in conjunction with the ECISD will coordinate the construction of the project through the Texas Department of Transportation who will provide all construction services;
3. All costs associated with Environmental Assessment and Engineering Service costs shall be paid up front by the ECISD to the City of McAllen;
4. McAllen will provide payment to engineering firm and will submit invoices to TxDOT for reimbursement;
5. McAllen will reimburse ECISD for engineering fees within 30 days upon receipt from TxDOT.
6. McAllen will designate personnel to assist with the coordination of the project;
7. ECISD will participate in the RFQ selection process; having complete control of the engineering firm selected for the project. McAllen agrees to ratify the selection through City Council Approval and subsequent engineering contract executions;
8. Each party agrees to conform to its own applicable purchasing laws, regulations, policies, and procedures with respect to the portion of the work under this Agreement performed by each party.

Conflict of Applicable Law: Nothing in this Agreement shall be construed so as to require the commission of any act contrary to law, and whenever there is any conflict between any provision of their Agreement and any present or future law, ordinance, or administrative, executive or judicial regulation, order or decree, or amendment thereof, contrary to which the parties have no legal right to contract, the latter shall prevail, but in such event the affected provision(s) of this Agreement shall be modified only to the extent necessary to bring them within the legal requirements and only during the time such conflict exists.

No Waiver: No waiver by any party hereto of any breach of any provision of the Agreement shall be deemed to be a waiver of any preceding or succeeding breach of the same or any

other provision hereof.

Entire Agreement: This Agreement contains the entire contract between the parties hereto and each party acknowledges that neither has made (either directly or through any agent or representative) any representation or agreement in connection with this Agreement not specifically set forth herein. This Agreement may be modified or amended only by agreement in writing executed by Edinburg and County, and not otherwise.

TEXAS LAW TO APPLY. THIS AGREEMENT SHALL BE CONSTRUED UNDER AND IN ACCORDANCE WITH THE LAWS OF THE STATE OF TEXAS, AND ALL OBLIGATION OF THE PARTIES CREATED HEREUNDER ARE PERFORMABLE IN HIDALGO COUNTY, TEXAS. THE PARTIES HEREBY CONSENT TO PERSONAL JURISDICTION IN HIDALGO COUNTY, TEXAS.

Notice. Except as may be otherwise specifically provided in this Agreement, all notices, demands, requests or communication required or permitted hereunder shall be in writing and shall either be (i) personally delivered against a written receipt, or (ii) sent by registered or certified mail, return receipt requested, postage prepaid and addressed to the parties at the addresses set forth below, or at such other addresses as may have been theretofore specified by written notice delivered in accordance herewith:

If to ECISD: Edinburg Consolidated Independent School District
Attention : Rene Gutierrez, Superintendent of Schools
411 N. 8th Street
Edinburg, Texas 78540

If to School District: City of McAllen
Attention: City Manager
1300 Houston Ave.
McAllen, Texas 78501

Each notice, demand, request or communication which shall be delivered or mailed in the manner described above shall be deemed sufficiently given for all purposes at such time as it is personally delivered to the addressee or, if mailed, at such time as it is deposited in the United States mail.

Additional Documents. The parties hereto covenant and agree that they will execute such other and further instruments and documents as are or may become necessary or convenient to effectuate and carry out the terms of this Agreement.

Successors. This Agreement shall be binding upon and inure to the benefit of the parties hereto and their respective heirs, executors, administrators, legal representatives, successors, and assigns where permitted by this Agreement.

3

Assignment. This Agreement shall not be assignable

Headings. The headings and captions contained in this Agreement are solely for convenience reference and shall not be deemed to affect the meaning or interpretation of any provision of paragraph hereof.

Gender and Number. All pronouns used in this Agreement shall include the other gender, whether used in the masculine, feminine or neuter gender, and singular shall include the plural whenever and so often as may be appropriate.

Authority to Execute. The execution and performance of this Agreement by Edinburg and County have been duly authorized by all necessary laws, resolutions corporate action, and this Agreement constitutes the valid and enforceable obligations of Edinburg and County in accordance with its terms

Governmental Purpose. Each party hereto is entering into this agreement for the purpose of providing for governmental services or functions and will pay for such services out of current revenues available to the paying party as herein provided.

Commitment of Current Revenues Only. In the event that, during any term, hereof, the governing body of any party does not appropriate sufficient funds to meet the obligations of such party under this Agreement, then any party may terminate this Agreement upon ninety (90) days written notice to the other party. Each of the parties hereto agrees, however, to use its best efforts to secure funds necessary for the continued performance of this Agreement. The parties intend this provision to be a continuing right to terminate this Agreement at the expiration of each budget period of each party hereto pursuant to the provisions of Tex. Loc. Govt. Code Ann. §271.903.

WITNESS THE HANDS OF THE PARTIES effective as of the day and year first written above.

CITY OF MCALLEN

Mike R. Perez, City Manager

ATTEST:

Annette Villarreal, City Secretary

4

EXHIBIT _____

**EDINBURG CONSOLIDATED INDEPENDENT
SCHOOL DISTRICT**

David Torres, President, School Board

ATTEST:

By: _____
Ciro Trevino, Secretary, Board of Trustees

APPROVED AS TO FORM:

By: _____
Kevin Pagan, City Attorney

By: _____
Jacques E. Trevino
District General Counsel

**APPROVAL OF INTERLOCAL AGREEMENT BETWEEN
HIDALGO COUNTY AND EDINBURG CISD FOR THE SAFE
ROUTES TO SCHOOL PROJECT**

Superintendent's Recommendation

That the Board of Trustees approves the Interlocal Agreement Between Hidalgo County and Edinburg CISD for the Safe Routes to School Project as prepared by Administration.

Rationale

The District and the County of Hidalgo were awarded the Safe Routes to School grant for five (5) campuses within the County limits totaling \$1,134,630. The County is presently waiting on the Advance Funding Agreement (AFA) with TxDOT, but may proceed with the Interlocal to retain the Project Engineer.

Under this agreement, the County will pay 100% of the Engineer fees and 50% of any construction cost overruns that may occur. The County will be reimbursed the 100% of the Engineer fee from TxDOT.

The District will participate in the RFQ process having complete control of the Engineering Firm selected for the project. The County will execute the contract for the Engineer.

The Facilities Committee has reviewed this item and recommended Board approval.

Budgetary Information

Account Number	Appropriation	Encumbrance	Expenditure	Balance
199-81-6216-00-xxx-199	\$ 3,500,000.00	\$0.00	\$0.00	\$ 3,500,000.00

Resource Personnel

Facilities Committee	Dr. Rene Gutiérrez
Mario Salinas	Sylvia Garcia
Robert Estrada	

Board Policy Reference

This is in accordance with Board Policy BAA (Legal) Board Powers and Duties.



Prepared by:	 Robert Estrada, District Architect
Approved by:	 Mario Salinas, Asst. Superintendent for District Administration
Within Budgetary Allocations:	 Sylvia Garcia, Director of Finance
Recommended by:	 Dr. Rene Gutierrez, Superintendent of Schools

Exhibit _____, Pages _____

ECISD SRTS DETAILED CONSTRUCTION COST ESTIMATE

NAME OF SCHOOL	ENGINEERING	ENVIRONMENTAL	CONSTRUCTION	CONSTRUCTION CONTINGENCIES	TOTAL
CITY OF EDINBURG					
Eisenhower Elem. / Memorial MS	50,000	10,000	370,000	65,000	495,000
Villarreal / Monte Cristo Elem.	40,000	10,000	380,760	65,000	495,760
De Zavala Elementary	40,000	10,000	381,900	65,000	496,900
Truman Elementary	40,000	10,000	382,870	65,000	497,870
Guerra Elementary	40,000	10,000	382,600	65,000	497,600
B.L. Garza Middle School	40,000	10,000	380,900	65,000	495,900
L.B. Johnson Elementary	40,000	10,000	381,480	65,000	496,480
Jefferson Elementary	40,000	10,000	381,480	65,000	496,480
Jose De Escandon Elementary	40,000	10,000	381,490	65,000	496,490
Cano-Gonzalez Elementary	40,000	10,000	378,960	65,000	493,960
Trevino Elementary	40,000	10,000	380,760	65,000	495,760
Harwell Middle School	40,000	10,000	382,560	65,000	497,560
Robert E. Lee Elementary	40,000	10,000	382,960	65,000	497,960
Freddy Gonzalez Elementary	40,000	10,000	382,560	65,000	497,560
Canterbury Elementary	40,000	10,000	380,470	65,000	495,470
South Middle School	40,000	10,000	380,470	65,000	495,470
Austin Elementary	50,000	10,000	372,650	65,000	497,650
Lincoln Elementary	50,000	10,000	369,875	65,000	494,875
Travis Elementary	50,000	10,000	373,360	65,000	494,875
De La Vina Elementary	40,000	10,000	382,560	65,000	497,560
TOTALS:	840,000	200,000	7,590,665	1,300,000	9,927,180
CITY OF EDINBURG COST:	420,000				
ECISD COST:	420,000				
CITY OF McALLEN					
Cavazos Elementary	30,000	10,000	286,870	65,000	376,870
TOTALS:	30,000	10,000	286,870	65,000	376,870
ECISD COST:	30,000				
HIDALGO COUNTY					
Carmen Avila Elementary	40,000	10,000	382,200	65,000	497,200
San Carlos / J.F. Kennedy Elem.	40,000	10,000	381,070	65,000	496,070
Esparza / Betts Elementary	50,000	10,000	371,360	65,000	496,360
TOTALS:	130,000	30,000	1,134,630	195,000	1,489,630
GRAND TOTAL:	1,000,000	240,000	9,012,165	1,560,000	11,793,680
ECISD GRAND TOTAL COST:	450,000				

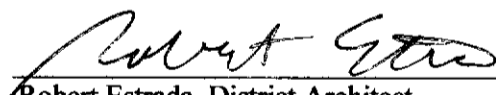
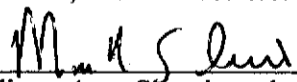
EXHIBIT _____

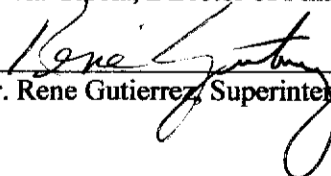
STATE OF TEXAS §

COUNTY OF HIDALGO §

**INTERLOCAL COOPERATION AGREEMENT
BETWEEN THE COUNTY OF HIDALGO AND THE EDINBURG CONSOLIDATED
INDEPENDENT SCHOOL DISTRICT**

This Agreement is made on this the ____ day of _____, 2010, by and between **HIDALGO COUNTY, TEXAS** hereinafter referred to as "County" and the **EDINBURG CONSOLIDATED INDEPENDENT SCHOOL DISTRICT**, hereinafter referred to as "ECISD," pursuant to the provisions of the Texas Interlocal Cooperation Act, as follows:

WITNESSETH:

WHEREAS, Edinburg Consolidated Independent School District through the County of Hidalgo applied for a Safe Routes to School Grant from the Texas Department of Transportation; and

WHEREAS, though Minute Order No. 112268 on May 27, 2010 City of Edinburg was granted \$1,134,630.00 through the Safe Routes to School Program (SRTS) Fund for the construction of improvements to three (3) campuses located within the County of Hidalgo belonging to the District; and

WHEREAS, County intends to enter into an Advance Funding Agreement (AFA) with the Texas Department of transportation for funds which will include in addition to the above, Preliminary Engineering (PS&E), Environmental Assessment, Right of Way Acquisition, and Construction Contingency costs to be provided by the Texas Department of Transportation.

WHEREAS, the County has determined that it will receive benefit from the infrastructure improvements and has agreed to assist ECISD; and

WHEREAS, ECISD has determined that it will receive benefit from the infrastructure improvements and has agreed to assist County; and

WHEREAS, ECISD and County have agreed to cooperate in the improvements as further herein described; and

WHEREAS, ECISD and County are authorized to enter into this Agreement pursuant to the Interlocal Cooperation Act, Texas Govt. Code 791.001 et seq., which authorizes local governments to contract with each other to perform governmental functions and services under the terms of the Act.

1

EXHIBIT _____

NOW, THEREFORE, Edinburg and County, in consideration of the mutual covenants expressed hereinafter, agree as follows:

1. The County will serve as the lead agency; executing the Advanced Funding Agreement with the Texas Department of Transportation, coordinating the RFQ process for Preliminary Engineering (PS&E Development), Environmental Assessment, and by providing Right of Way Acquisition Services (if necessary) and providing submissions to the Texas Department of Transportation, as required by the Safe Routes to School (SRTS) Program;
2. The County in conjunction with the ECISD will coordinate the construction of the project through the Texas Department of Transportation who will provide all construction services;
3. All Engineering costs shall be paid for by the County;
4. County will provide payment to Engineering firm and will submit the invoices to the Texas Department of Transportation for reimbursement;
5. The County and ECISD will share in 50% of any construction cost overruns to the project, with payments made to the Texas Department of Transportation (TxDOT) in accordance with terms in the executed Advanced Funding Agreement (AFA);
6. County will designate personnel to assist with the coordination of the project;
7. The District will participate in the RFQ process, having complete control of the engineering firm selected for the project. County agrees to ratify the selection through Commissioner's Court approval and subsequent engineering contract execution.
8. Each party agrees to conform to its own applicable purchasing laws, regulations, policies, and procedures with respect to the portion of the work under this Agreement performed by each party.

Conflict of Applicable Law: Nothing in this Agreement shall be construed so as to require the commission of any act contrary to law, and whenever there is any conflict between any provision of their Agreement and any present or future law, ordinance, or administrative, executive or judicial regulation, order or decree, or amendment thereof, contrary to which the parties have no legal right to contract, the latter shall prevail, but in such event the affected provision(s) of this Agreement shall be modified only to the extent necessary to bring them within the legal requirements and only during the time such conflict exists.

No Waiver: No waiver by any party hereto of any breach of any provision of the Agreement shall be deemed to be a waiver of any preceding or succeeding breach of the same or any

other provision hereof.

Entire Agreement: This Agreement contains the entire contract between the parties hereto and each party acknowledges that neither has made (either directly or through any agent or representative) any representation or agreement in connection with this Agreement not specifically set forth herein. This Agreement may be modified or amended only by agreement in writing executed by Edinburg and County, and not otherwise.

TEXAS LAW TO APPLY. THIS AGREEMENT SHALL BE CONSTRUED UNDER AND IN ACCORDANCE WITH THE LAWS OF THE STATE OF TEXAS, AND ALL OBLIGATION OF THE PARTIES CREATED HEREUNDER ARE PERFORMABLE IN HIDALGO COUNTY, TEXAS. THE PARTIES HEREBY CONSENT TO PERSONAL JURISDICTION IN HIDALGO COUNTY, TEXAS.

Notice. Except as may be otherwise specifically provided in this Agreement, all notices, demands, requests or communication required or permitted hereunder shall be in writing and shall either be (i) personally delivered against a written receipt, or (ii) sent by registered or certified mail, return receipt requested, postage prepaid and addressed to the parties at the addresses set forth below, or at such other addresses as may have been theretofore specified by written notice delivered in accordance herewith:

If to ECISD: Edinburg Consolidated Independent School District
Attention : Rene Gutierrez, Superintendent of Schools
411 N. 8th St.
Edinburg, Texas 78540

If to County of Hidalgo: County of Hidalgo
Attention: Rene A. Ramirez, Hidalgo County Judge
100 E. Cano St.
Edinburg, Texas 78539

Each notice, demand, request or communication which shall be delivered or mailed in the manner described above shall be deemed sufficiently given for all purposes at such time as it is personally delivered to the addressee or, if mailed, at such time as it is deposited in the United States mail.

Additional Documents. The parties hereto covenant and agree that they will execute such other and further instruments and documents as are or may become necessary or convenient to effectuate and carry out the terms of this Agreement.

Successors. This Agreement shall be binding upon and inure to the benefit of the parties hereto and their respective heirs, executors, administrators, legal representatives, successors, and assigns where permitted by this Agreement.

3

Assignment. This Agreement shall not be assignable

Headings. The headings and captions contained in this Agreement are solely for convenience reference and shall not be deemed to affect the meaning or interpretation of any provision of paragraph hereof.

Gender and Number. All pronouns used in this Agreement shall include the other gender, whether used in the masculine, feminine or neuter gender, and singular shall include the plural whenever and so often as may be appropriate.

Authority to Execute. The execution and performance of this Agreement by Edinburg and County have been duly authorized by all necessary laws, resolutions corporate action, and this Agreement constitutes the valid and enforceable obligations of Edinburg and County in accordance with its terms

Governmental Purpose. Each party hereto is entering into this agreement for the purpose of providing for governmental services or functions and will pay for such services out of current revenues available to the paying party as herein provided.

Commitment of Current Revenues Only. In the event that, during any term, hereof, the governing body of any party does not appropriate sufficient funds to meet the obligations of such party under this Agreement, then any party may terminate this Agreement upon ninety (90) days written notice to the other party. Each of the parties hereto agrees, however, to use its best efforts to secure funds necessary for the continued performance of this Agreement. The parties intend this provision to be a continuing right to terminate this Agreement at the expiration of each budget period of each party hereto pursuant to the provisions of Tex. Loc. Govt. Code Ann. §271.903.

WITNESS THE HANDS OF THE PARTIES effective as of the day and year first written above.

HIDALGO COUNTY, TEXAS

Rene A. Ramirez, Hidalgo County Judge

Approved by Commissioners' Court

On: _____

4

EXHIBIT _____

ATTEST:

Arturo Guajardo, Jr., County Clerk

**EDINBURG CONSOLIDATED INDEPENDENT
SCHOOL DISTRICT**

David Torres, President, School Board

ATTEST:

By: _____
Ciro Trevino, Secretary, Board of Trustees

APPROVED AS TO FORM:

By: _____
Jacques E. Trevino
District General Counsel

Atlas & Hall, L.L.P.

By: _____
Stephen L. Crain

5

EXHIBIT _____

APPROVAL OF INTERLOCAL AGREEMENT BETWEEN CITY OF EDINBURG AND EDINBURG CISD FOR THE SAFE ROUTES TO SCHOOL PROJECT

Superintendent's Recommendation

That the Board of Trustees approves the Interlocal Agreement Between the City of Edinburg and Edinburg CISD for the Safe Routes to School Project as prepared by Administration.

Rationale

The District and the City of Edinburg were awarded the Safe Routes to School grant for Twenty-Two (22) campuses within the City of Edinburg limits totaling \$7,590,665 for construction and Engineering fee. The City is presently waiting on the Advance Funding Agreement (AFA) with TxDOT, but may proceed with the Interlocal to retain the Project Engineer.

Under this agreement, the District will pay the City \$420,000 or 50% for the Engineer fees and 50% of any construction cost overruns that may occur. The Engineer fee will be 100% reimbursable.

The District will participate in the RFQ process having complete control of the Engineering Firm selected for the project. The City will execute the contract for the Engineer.

The Facilities Committee has reviewed this item and recommended Board approval.

Budgetary Information

Account Number	Appropriation	Encumbrance	Expenditure	Balance
199-81-6216-00-xxx-199	\$ 3,500,000.00	\$0.00	\$0.00	\$3,500,000.00

Resource Personnel

Facilities Committee Dr. Rene Gutierrez
 Mario Salinas Sylvia Garcia
 Robert Estrada

Board Policy Reference

This is in accordance with Board Policy BAA (Legal) Board Powers and Duties.

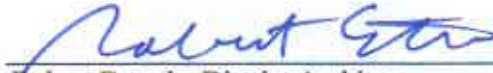
Prepared by: 
 Robert Estrada, District Architect

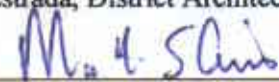
Approved by: 
 Mario Salinas, Asst. Superintendent for District Administration

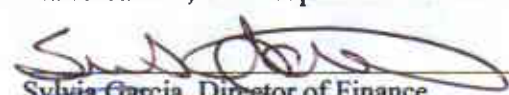
Within Budgetary Allocations: 
 Sylvia Garcia, Director of Finance

Recommended by: 
 Dr. Rene Gutierrez, Superintendent of Schools

Exhibit _____, Pages _____

ECISD SRYS DETAILED CONSTRUCTION COST ESTIMATE

NAME OF SCHOOL	ENGINEERING	ENVIRONMENTAL	CONSTRUCTION	CONSTRUCTION CONTINGENCIES	TOTAL
CITY OF EDINBURG					
Eisenhower Elem. / Memorial MS	50,000	10,000	370,000	65,000	495,000
Villarreal / Monte Cristo Elem.	40,000	10,000	380,760	65,000	495,760
De Zavala Elementary	40,000	10,000	381,900	65,000	496,900
Truman Elementary	40,000	10,000	382,870	65,000	497,870
Guerra Elementary	40,000	10,000	382,600	65,000	497,600
B.L. Garza Middle School	40,000	10,000	380,900	65,000	495,900
L.B. Johnson Elementary	40,000	10,000	381,480	65,000	496,480
Jefferson Elementary	40,000	10,000	381,480	65,000	496,480
Jose De Escandon Elementary	40,000	10,000	381,490	65,000	496,490
Cano-Gonzalez Elementary	40,000	10,000	378,960	65,000	493,960
Trevino Elementary	40,000	10,000	380,760	65,000	495,760
Harwell Middle School	40,000	10,000	382,560	65,000	497,560
Robert E. Lee Elementary	40,000	10,000	382,960	65,000	497,960
Freddy Gonzalez Elementary	40,000	10,000	382,560	65,000	497,560
Canterbury Elementary	40,000	10,000	380,470	65,000	495,470
South Middle School	40,000	10,000	380,470	65,000	495,470
Austin Elementary	50,000	10,000	372,650	65,000	497,650
Lincoln Elementary	50,000	10,000	369,875	65,000	494,875
Travis Elementary	50,000	10,000	373,360	65,000	494,875
De La Vina Elementary	40,000	10,000	382,560	65,000	497,560
TOTALS:	840,000	200,000	7,590,665	1,300,000	9,927,180
CITY OF EDINBURG COST:	420,000				
ECISD COST:	420,000				
CITY OF McALLEN					
Cavazos Elementary	30,000	10,000	286,870	65,000	376,870
TOTALS:	30,000	10,000	286,870	65,000	376,870
ECISD COST:	30,000				
HIDALGO COUNTY					
Carmen Avila Elementary	40,000	10,000	382,200	65,000	497,200
San Carlos / J.F. Kennedy Elem.	40,000	10,000	381,070	65,000	496,070
Esparza / Betts Elementary	50,000	10,000	371,360	65,000	496,360
TOTALS:	130,000	30,000	1,134,630	195,000	1,489,630
GRAND TOTAL:	1,000,000	240,000	9,012,165	1,560,000	11,793,680
ECISD GRAND TOTAL COST:	450,000				

EXHIBIT

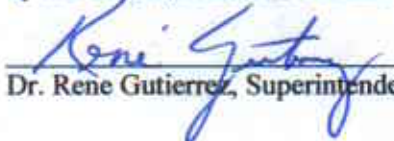
STATE OF TEXAS §

COUNTY OF HIDALGO §

CITY OF EDINBURG §

**INTERLOCAL COOPERATION AGREEMENT
BETWEEN THE CITY OF EDINBURG AND THE
EDINBURG CONSOLIDATED INDEPENDENT SCHOOL DISTRICT**

This Agreement is made on this the _____ day of _____, 2010, by and between the **EDINBURG CONSOLIDATED INDEPENDENT SCHOOL DISTRICT** hereinafter referred to as "ECISD" and the **CITY OF EDINBURG, TEXAS**, hereinafter referred to as "Edinburg," pursuant to the provisions of the Texas Interlocal Cooperation Act, as follows:

WITNESSETH:

WHEREAS, Edinburg Consolidated Independent School District through the City of Edinburg applied for a Safe Routes to School Grant from the Texas Department of Transportation; and,

WHEREAS, though Minute Order No. 112268 on May 27, 2010 City of Edinburg was granted \$7,590,665.00 through the Safe Routes to School Program (SRTS) Fund for the construction of improvements to twenty campuses located within the City of Edinburg, belonging to the district; and,

WHEREAS, Edinburg intends to enter into an Advance Funding Agreement (AFA) with the Texas Department of Transportation for funds which will include in addition to the above, Preliminary Engineering (PS&E), Environmental Assessment, Right of Way Acquisition, and Construction Contingency costs to be provided by the Texas Department of Transportation; and,

WHEREAS, Edinburg has determined that it will receive benefit from the infrastructure improvements and has agreed to assist ECISD; and,

WHEREAS, the ECISD has determined that it will receive benefit from the infrastructure improvements and has agreed to assist Edinburg; and,

WHEREAS, Edinburg and the ECISD have agreed to cooperate in the improvements as further herein described; and,

WHEREAS, Edinburg and the ECISD are authorized to enter into this Agreement pursuant to the Interlocal Cooperation Act, Texas Govt. Code 791.001 et seq., which authorizes local governments to contract with each other to perform governmental functions and services under the terms of the Act.

EXHIBIT _____

NOW, THEREFORE, Edinburg and the ECISD, in consideration of the mutual covenants expressed hereinafter, agree as follows:

1. Edinburg will serve as the lead agency; executing the Advanced Funding Agreement with the Texas Department of Transportation, coordinating the RFQ process for Preliminary Engineering and (PS&E Development), Environmental Assessment, and by providing Right of Way Acquisition Services (if necessary), and providing submissions to the Texas Department of Transportation, as required by the Safe Routes to School (SRTS) Program;
2. City will coordinate the construction of the project through the Texas Department of Transportation who will provide construction services;
3. Upon receipt of invoices from the Engineering firm, Edinburg will invoice ECISD for fifty percent (50%) of all costs of services, which will be due and payable to Edinburg within 30 days of receipt of invoice by the ECISD;
4. City, upon receipt of payment by ECISD, will provide payment to Engineering firm and will submit the invoices to the Texas Department of Transportation for reimbursement;
5. City will reimburse ECISD its 50% share of costs within 30 days of receipt of reimbursement of funds from the Texas Department of Transportation;
6. The ECISD and City will share in 50% of any construction cost overruns to the project with payments made to TxDOT in accordance with terms in the executed Advance Funding Agreement;
7. ECISD will designate personnel to assist with the coordination of the project;
8. ECISD will participate in the RFQ selection process; having complete control of the engineering firm selected for the project. Edinburg agrees to ratify the selection through City Council Approval and subsequent engineering contract executions;
9. Each party agrees to conform to its own applicable purchasing laws, regulations, policies, and procedures with respect to the portion of the work under this Agreement performed by each party.

Conflict of Applicable Law: Nothing in this Agreement shall be construed so as to require the commission of any act contrary to law, and whenever there is any conflict between any provision of their Agreement and any present or future law, ordinance, or administrative, executive or judicial regulation, order or decree, or amendment thereof, contrary to which the parties have no legal right to contract, the latter shall prevail, but in such event the affected provision(s) of this Agreement shall be modified only to the extent necessary to bring them within the legal requirements and only during the time such conflict exists.

No Waiver: No waiver by any party hereto of any breach of any provision of the Agreement shall be

deemed to be a waiver of any preceding or succeeding breach of the same or any other provision hereof.

Entire Agreement: This Agreement contains the entire contract between the parties hereto and each party acknowledges that neither has made (either directly or through any agent or representative) any representation or agreement in connection with this Agreement not specifically set forth herein. This Agreement may be modified or amended only by agreement in writing executed by Edinburg and ECISD, and not otherwise.

TEXAS LAW TO APPLY. THIS AGREEMENT SHALL BE CONSTRUED UNDER AND IN ACCORDANCE WITH THE LAWS OF THE STATE OF TEXAS, AND ALL OBLIGATION OF THE PARTIES CREATED HEREUNDER ARE PERFORMABLE IN HIDALGO COUNTY, TEXAS. THE PARTIES HEREBY CONSENT TO PERSONAL JURISDICTION IN HIDALGO COUNTY, TEXAS.

Notice. Except as may be otherwise specifically provided in this Agreement, all notices, demands, requests or communication required or permitted hereunder shall be in writing and shall either be (i) personally delivered against a written receipt, or (ii) sent by registered or certified mail, return receipt requested, postage prepaid and addressed to the parties at the addresses set forth below, or at such other addresses as may have been theretofore specified by written notice delivered in accordance herewith:

If to ECISD: Edinburg Consolidated Independent School District
Attention : Rene Gutierrez, Superintendent of Schools
411 N. 8th Street
Edinburg, Texas 78540

If to Edinburg: City of Edinburg
Attention: Ramiro Garza, Jr., City Manager
P.O. Box 1079 – 415 W. University Drive
Edinburg, Texas 78541-1079

Each notice, demand, request or communication which shall be delivered or mailed in the manner described above shall be deemed sufficiently given for all purposes at such time as it is personally delivered to the addressee or, if mailed, at such time as it is deposited in the United States mail.

Additional Documents. The parties hereto covenant and agree that they will execute such other and further instruments and documents as are or may become necessary or convenient to effectuate and carry out the terms of this Agreement.

Successors. This Agreement shall be binding upon and inure to the benefit of the parties hereto and their respective heirs, executors, administrators, legal representatives, successors, and assigns where permitted by this Agreement.

Assignment. This Agreement shall not be assignable

Headings. The headings and captions contained in this Agreement are solely for convenience reference and shall not be deemed to affect the meaning or interpretation of any provision of paragraph hereof.

Gender and Number. All pronouns used in this Agreement shall include the other gender, whether used in the masculine, feminine or neuter gender, and singular shall include the plural whenever and so often as may be appropriate.

Authority to Execute. The execution and performance of this Agreement by Edinburg and District have been duly authorized by all necessary laws, resolutions corporate action, and this Agreement constitutes the valid and enforceable obligations of Edinburg and District in accordance with its terms.

Governmental Purpose. Each party hereto is entering into this agreement for the purpose of providing for governmental services or functions and will pay for such services out of current revenues available to the paying party as herein provided.

Commitment of Current Revenues Only. In the event that, during any term, hereof, the governing body of any party does not appropriate sufficient funds to meet the obligations of such party under this Agreement, then any party may terminate this Agreement upon ninety (90) days written notice to the other party. Each of the parties hereto agrees, however, to use its best efforts to secure funds necessary for the continued performance of this Agreement. The parties intend this provision to be a continuing right to terminate this Agreement at the expiration of each budget period of each party hereto pursuant to the provisions of Texas Local Government Code §271.903.

WITNESS THE HANDS OF THE PARTIES effective as of the day and year first written above.

EDINBURG CISD

By: _____
David Torre, President, Board of Trustees

ATTEST:

By: _____
Ciro Trevino, Secretary, Board of Trustees

APPROVED AS TO FORM:

By: _____
Jacques E. Trevino, District General Counsel

CITY OF EDINBURG

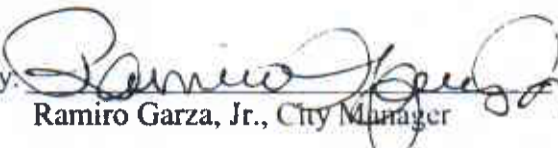
By: 
Ramiro Garza, Jr., City Manager

ATTEST:

By: 
Myra L. Ayala Garza, City Secretary



APPROVED AS TO FORM:
Gonzalez-Palacios LLP
Attorneys at Law

By: 
Gerald Castell
City Attorney

EXHIBIT

APPROVAL OF AGREEMENT BETWEEN TEXAS A&M UNIVERSITY SYSTEM HEALTH SCIENCE CENTER RESEARCH FOUNDATION AND EDINBURG CISD FOR PARK IMPROVMENTS AT VILLARREAL AND MONTE CRISTO ELEMENTARY SCHOOLS

Superintendent's Recommendation

That the Board of Trustees approves the Agreement Between Texas A&M University System Health Science Center Research Foundation and Edinburg CISD for Park Improvements at Villarreal and Monte Cristo Elementary Schools as prepared by Administration.

Rationale

Texas A&M University System Health Science Center Research Foundation will be contributing \$43,055 for walking trail improvements at Villarreal and Monte Cristo Elementary Schools as part of the "Enhancing Infrastructure Supporting Walking" project as shown on attached drawings.

Under this agreement the Phase I of this project is to install six (6) solar lights and a crush granite trail as part of the infrastructure improvements. The District will assist in providing plans and specifications to be bid and built by the University. Phase II of this project will be done as part of a future grant or possible funding from City or County.

The Facilities Committee has reviewed this item and recommended Board approval.

Budgetary Information

N/A

Resource Personnel

Facilities Committee	Dr. Rene Gutiérrez
Mario Salinas	Sylvia Garcia
Robert Estrada	

Board Policy Reference

This is in accordance with Board Policy BAA (Legal) Board Powers and Duties.

Prepared by:

Robert Estrada, District Architect

Approved by:

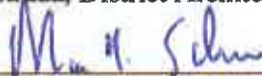
Mario Salinas, Asst. Superintendent for District Administration

Within Budgetary Allocations:

Sylvia Garcia, Director of Finance

Recommended by:



Dr. Rene Gutierrez, Superintendent of Schools

Exhibit _____, Pages _____

STATE OF TEXAS §

COUNTY OF HIDALGO §

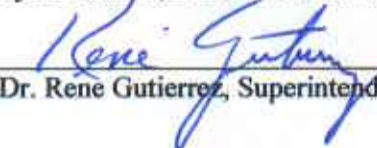
AGREEMENT BETWEEN THE EDINBURG CONSOLIDATED INDEPENDENT SCHOOL DISTRICT AND THE TEXAS A&M UNIVERSITY SYSTEM HEALTH SCIENCE CENTER RESEARCH FOUNDATION: JOINT USE AND DEVELOPMENT OF PLAYGROUND AREAS

This Agreement is made and entered into by and between the **EDINBURG CONSOLIDATED INDEPENDENT SCHOOL DISTRICT ("District")**, and the **TEXAS A&M UNIVERSITY SYSTEM HEALTH SCIENCE CENTER RESEARCH FOUNDATION ("TAM HSC RF")**, for the purpose of joint use and development of playground areas owned and operated by the School District.

I. RECITALS

WHEREAS, TAM HSC RF received a contract, Enhancing Infrastructure Supporting Walking, from the Texas Department of State Health Services, Contract #2010-034879(Prime Contract") to support infrastructure improvement at two District campuses, Villarreal and Monte Cristo Elementary Schools, and some of the grant funds will be used for implementation to improve the health of school children by providing playground and walking trails;

WHEREAS, the District owns playground areas located within the City, and both parties acknowledge that the joint use and development of the playground areas is in the best interest of the District and the Community;

WHEREAS, the joint use and development of playground areas by the TAM HSC RF and the District better utilizes the taxpayers' facilities by decreasing the cost of services and by increasing the quality of life for both the citizens of the Community and the District;

WHEREAS, the District is organized as a Consolidated Independent School District under the laws of the State of Texas for the purpose of educating and providing other activities which assist and benefit the youth and general community within its District boundary;

WHEREAS, District and TAM HSC RF agrees that access to the District's playground areas will enable the TAM HSC RF to provide infrastructure for Healthy Living activities for the children of the community; and

WHEREAS, District and TAM HSC RF acknowledge that this exchange of functions or services results in an exchange that fairly compensates the performing parties for the services or functions performed under this Agreement.

NOW, THEREFORE, and in consideration of the premises and the mutual promises, covenants and agreements set forth in this Agreement, TAM HSC RF and District agree as follows:

II. CONSIDERATIONS

A. Mutual Promises

1. The TAM HSC RF appoints Jane Zuber, Associate Vice President to designate Dr. Ann Millard as TAM HSC RF Principal Investigator (TAM HSC RF PI") to implement the provisions of this Agreement.

EXHIBIT _____

2. The District appoints the Superintendent or his designee to implement the provisions of this Agreement.
3. The District shall provide construction documents; assist in the bidding and the construction administration for the said walking trail and lights by the Superintendent or his designee to implement the provisions of this Agreement.
4. The Superintendent, in consultation with the Board President and TAM HSC RF PI, shall confer at the earliest practical date to designate those areas, which in their opinion, can be jointly utilized and developed as playground areas by the District and the Community.
5. The TAM HSC RF shall, promptly after trail areas are specified and contingent upon the availability of budgeted funds allocated for this purpose pursuant to the Prime Contract, erect Phase I Walking Trail and Lights which in the opinion of both entities can be used for such activities as soccer matches, walking, picnics and other recreational activities generally associated with a park. All such equipment must conform to federal, state, district laws and policies.
6. The TAM HSC RF shall erect, at its sole cost, to the extent of available budgeted funds allocated for this purpose pursuant to the Prime Contract, the Walking Trail and Lights, and the District shall maintain and keep in repair at its sole cost all said property on the premises.
7. The TAM HSC RF and District shall jointly design walking trails and playground areas for Phase I & II and shall utilize the professional services of contracted architects and engineers as necessary, to the extent of available budgeted funds allocated for this purpose pursuant to the Prime Contract.

B. Hours of Operation and Use:

1. During regular school hours, the District shall have use of the playground areas. School hours are 30 minutes before regular classes to 30 minutes after regular classes.
2. During non-school hours, the community shall have use of the playground areas.

C. Liability Insurance.

1. Each entity shall carry sufficient liability insurance: in the case of the district, which insurance shall be at the statutorily required limits.
2. The District may be found negligent only as is provided by the Texas Tort Claims Act.

III. MUTUAL INDEMNIFICATION

1. The District will defend, indemnify and hold harmless the TAM HSC RF from all damages, costs, expenses, and attorney's fees for all claims and suits, including claims and suits for death, personal injury, and property damage, arising out of, or connected with the use of the playground areas.
2. During the term of this agreement, TAM HSC RF will defend, indemnify and hold harmless the District from all damages, costs, expenses, and attorney's fees for all claims and suits, including claims and suits for death, personal injury, and property damage, arising out of, or connected with the negligence or malfeasance of TAM HSC RF, its employees, agents and representative in connection with TAM HSC RF's erection of the playground areas (Claims"). At the expiration or termination of this Agreement, all liability for Claims will be responsibility of the District, and this indemnification will not survive the expiration or termination of this Agreement.

IV. GOVERNING LAW

This Agreement shall be construed under and in accordance with the laws of the State of Texas, and all obligations of the parties created by this Agreement as performable in Hidalgo County, Texas.

V. SUCCESSORS AND ASSIGNS

Should the District's Superintendent and TAM HSC RF Vice President or their designees and/or successors in office, after pledging to use their best efforts to facilitate and implement the provisions of this Agreement, encounter a conflict they are unable to resolve, the respective governing bodies shall meet as soon as practicable at a time and place mutually convenient to both parties to resolve the conflict. If the TAM HSC RF and the District are unable to resolve the conflict, Dispute Resolution (as defined in Article XI) shall be mandatory prior to resorting to legal remedy. This Agreement shall be binding on and inure to the benefit of the District and the TAM HSC RF and their representatives, successors and assigns when permitted by the Agreement.

VI. EFFECTIVE DATE/TERM

This Agreement shall be in full force and effect beginning the first day of the month preceding its approval by both the District and the TAM HSC RF.

VII. NOTICES OF TERMINATION

This Agreement may be terminated for convenience by either party at any time to the full term of the Agreement period provided that a written notice is given to the other party thirty (30) days in advance.

VIII. FIXTURES-SPECIAL CONDITIONS

Upon the termination, expiration, or cancellation of this Agreement by either the District or TAM HSC RF, any movable equipment or appurtenances shall not be removed and taken by the TAM HSC RF. The equipment and solar lights shall become the sole property of the District.

IX. ENTIRE AGREEMENT

This contract contains the entire Agreement of the parties with respect to the matters covered by its terms. No other agreement, statement or promise made by any party or to any employee, officer or agent of any party, that is not contained in this Agreement, shall be of force or effect, unless the same be in writing, dated subsequent to the date hereof and duly executed by the parties hereto.

X. LEGAL CONSTRUCTION/SEVERABILITY

In case anyone or more of the provisions contained in this Agreement shall for any reason be held to be invalid, illegal or unenforceable in any respect, such invalidity, illegality or unenforceability shall not affect any other provision thereof, and this Agreement shall be construed as if such invalid, illegal or unenforceable provision had never been contained herein.

XI DISPUTE RESOLUTION

It is the intent of the parties that litigation be avoided, and in order to allow for the quick resolution of any and all disputes, if any, the parties hereby agree that any claims, demands or disputes that cannot be amicably resolved between the parties upon written request by either, party shall be submitted within two weeks to a neutral, trained party for assistance in dispute resolution by means of non-binding mediation. If mediation efforts are unsuccessful, parties may resort to protecting their rights by litigation in district court.

Said neutral third party should, if possible, be a local person with a background in dispute resolution and subject law. If the parties cannot agree on a third party neutral, then they shall submit the process to the American Arbitration Association for the selection of a third party neutral and the accomplishment of the dispute resolution, in accordance with its guidelines.

XII NOTICES

Formal notices provided under this Agreement must be in writing and delivered by (i) certified mail, return receipt requested; (ii) hand delivered; (iii) facsimile with receipt of a successful transmission confirmation; (iv) email; or (v) delivery by a reputable overnight courier service (in the case of delivery by facsimile or email the notice must be followed immediately by a copy of the notice being delivered by a means provided in (i), (ii), or (v)). The notice will be deemed given on the day the notice is received. In the case of notice by facsimile or email, the notice is deemed received at the local time of the receiving machine, and if not received, then the date the follow-up copy is received. Notices must be delivered to the following addresses or at such other addresses as may be later designated in writing.

EDINBURG CONSOLIDATED INDEPENDENT SCHOOL DISTRICT

411 North 8th Avenue

Edinburg, TX 78539

Attention: Dr Rene Gutierrez, Superintendent of Schools

Telephone: 956-289-2300

Fax: 956-289-2300

Email: rene.gutierrez@ecisd.us

TAM HSC RF: TEXAS A&M UNIVERSITY HEALTH SCIENCE CENTER RESEARCH FOUNDATION

400 Harvey Mitchell Parkway South, Suite 100

College Station, TX 77845

Attention: Lisa Whitten

Telephone: 979-862-8465

Fax: 979-862-3250

Email: lwhitten@rf-mail.tamu.edu

THIS AGREEMENT is executed in duplicate originals, copies of which shall be considered a true and correct original copy of this Agreement.

**EDINBURG CONSOLIDATED
INDEPENDENT SCHOOL DISTRICT
440 North 8th Street
Edinburg, TX 78539**

BY: _____
David Torrez, President, Board of Trustees

ATTEST:

BY: _____
Ciro Trevino, Secretary, Board of Trustees

**TEXAS A&M UNIVERSITY SYSTEM
HEALTH SCIENCE CENTER RESEARCH
FOUNDATION
400 Harvey Mitchell Parkway South, Suite 100
College Station, TX 77845**

BY: _____
Jane Zuber Associate Vice President
Texas A&M University System Health
Science Center Research Foundation

APPROVED AS TO FORM:

BY: _____
Jacques Trevino, Attorney for Edinburg CISD

Villarreal / Monte Cristo Elementary Walking Trail

		Description	Qty.	Unit Cost	Total
Phase I					
	1	Walking Trail Solar Lights	6	\$ 5,000.00	\$ 30,000.00
	2	Walking Trail - Crush Granite 1500 LF	1500	\$ 8.00	\$ 12,000.00
	Total				\$ 42,000.00
Phase II					
	1	Walking Trail - Crush Granite 3000 LF	3,000	\$ 15.00	\$ 45,000.00
	2	Playground Equipment	1	\$ 50,000.00	\$ 50,000.00
	3	Concrete Benchs	12	\$ 150.00	\$ 1,800.00
	4	Exercise Stations	5	\$ 250.00	\$ 1,250.00
	5	Live Oak	10	\$ 150.00	\$ 1,500.00
	6	Monterrey Oak Tree	6	\$ 250.00	\$ 1,500.00
	7	Wild Olive Tree	8	\$ 125.00	\$ 1,000.00
	8	Pygmy Date Palm	2	\$ 50.00	\$ 100.00
	9	2" Cypress Mulch	15	\$ 5.00	\$ 75.00
	10	Tree Rings (Steel)	26	\$ 20.00	\$ 520.00
	11	Walkng Trail Solar Lights	10	\$ 6,000.00	\$ 60,000.00
	Total				\$ 162,745.00

EXHIBIT



WALKING TRAIL - PHASE I
FOR
MONTE CRISTO & VILLA RREAL ELEMENTARY
 EDINBURG CONSOLIDATED INDEPENDENT SCHOOL DISTRICT

EDINBURG,

TEXAS



FACILITIES
 DEPARTMENT
 LUIS E. VERNIER
 EDINBURG, TEXAS 78549
 PHONE: (361) 251-1000
 FAX: (361) 251-1000

WORK ORDER No. _____
 DATE: _____
 BY: _____
 CHECKED BY: _____
 SHEET No. **1.1**
 TOTAL SHEETS: **1.1**
WALKING TRAIL PLAN

EXHIBIT

APPROVAL OF 2010-2011 CAPITAL IMPROVEMENT PROJECTS

Superintendent's Recommendation

That the Board of Trustees approves the 2010-2011 Capital Improvement Projects as prepared by Administration.

Rationale

The 2010-2011 District Budget included \$1,500,000 for construction projects District wide. The Safe Routes to School project will require \$500,000 for engineering fees but will be reimbursed. The \$1,000,000 will be divided into eight different projects taken from the District 5 Year Assessment Plan as shown below:

Campus Code:	Campus Name:	Project:	Cost:
118	San Carlos Elementary	Classroom Renovations	\$ 375,000.00
103	Hargill Elementary	Canopy to Student Drop-Off	\$ 75,000.00
112	Freddy Gonzalez Elementary	Portable Stage & Acoustics at Gym	\$ 80,000.00
123	Cavazos Elementary	Roof Renovation	\$ 150,000.00
107	Robert E. Lee Elementary	Repave Parking Lot & Drives	\$ 220,000.00
117	De La Vina Elementary	Parking Lot Lighting	\$ 50,000.00
103	Hargill Elementary	New Irrigation Sprinkler System	\$ 25,000.00
106	Trevino Elementary	New Irrigation Sprinkler System	\$ 25,000.00
Facility Needs Assessment Total:			\$ 1,000,000.00

The Facilities Committee has reviewed this item and recommended Board approval.

Budgetary Information

Account Number	Appropriation	Encumbrance	Expenditure	Balance
199-81-6629-00-118-199	\$ 375,000.00	\$0.00	\$0.00	\$ 375,000.00
199-81-6629-00-103-199	\$ 100,000.00	\$0.00	\$0.00	\$ 100,000.00
199-81-6629-00-112-199	\$ 80,000.00	\$0.00	\$0.00	\$ 80,000.00
199-81-6629-00-123-199	\$ 150,000.00	\$0.00	\$0.00	\$ 150,000.00
199-81-6629-00-107-199	\$ 220,000.00	\$0.00	\$0.00	\$ 220,000.00
199-81-6629-00-117-199	\$ 50,000.00	\$0.00	\$0.00	\$ 50,000.00
199-81-6629-00-106-199	\$ 25,000.00	\$0.00	\$0.00	\$ 25,000.00

Resource Personnel

Facilities Committee
 Mario Salinas
 Robert Estrada

Dr. Rene Gutiérrez
 Sylvia Garcia

Board Policy Reference

This is in accordance with Board Policy BAA (Legal) Board Powers and Duties.

Prepared by:

 Robert Estrada, District Architect

Approved by:

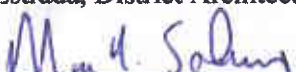
 Mario Salinas, Asst. Superintendent for District Administration

Within Budgetary
 Allocations:

 Sylvia Garcia, Director of Finance

Recommended by:



 Dr. Rene Gutierrez, Superintendent of Schools

Exhibit _____, Pages _____

**ECISD 2010 FACILITY NEEDS
ASSESSMENT**

Campus Code:	Campus Name:	Project:	Cost:
118	San Carlos Elementary	Classroom Renovations	\$ 375,000.00
103	Hargill Elementary	Canopy to Student Drop-Off	\$ 75,000.00
112	Freddy Gonzalez Elementary	Portable Stage & Acoustics at Gym	\$ 80,000.00
123	Cavazos Elementary	Roof Renovation	\$ 150,000.00
107	Robert E. Lee Elementary	Repave Parking Lot & Drives	\$ 220,000.00
117	De La Vina Elementary	Parking Lot Lighting	\$ 50,000.00
103	Hargill Elementary	New Irrigation Sprinkler System	\$ 25,000.00
106	Trevino Elementary	New Irrigation Sprinkler System	\$ 25,000.00
		Facilty Needs Assessment Total:	\$ 1,000,000.00

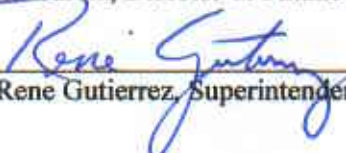
EXHIBIT _____

A	B	C	D	E	F	G	H	I	J
ECISD 2010 FACILITY NEEDS ASSESSMENT			2008 Bond	Future Bond	PROPOSED BUDGET 2010-2011	PROPOSED BUDGET 2011-2012	PROPOSED BUDGET 2012-2013	PROPOSED BUDGET 2013-2014	PROPOSED BUDGET 2014-2015
1	2	Description							
3	Campus								
4	September								
5	1 Elementary Schools								
6		4 - New Schools	\$ 39,200,000.00						
7		3 - New Schools		\$ 30,000,000.00					
8									
9	2 Middle Schools								
10		2 - New Schools	\$ 46,000,000.00						
11		2 - New Schools		\$ 42,000,000.00					
12									
13	3 Fine Arts Centers								
14	EHS, ENHS, JEHS								
15		3 - New Buildings	\$ 19,600,000.00						
16									
17	4 4th High School - Renovate Harwell								
18		Renovate Building	\$ 1,000,000.00						
19	Robert Vela High	New Fine Arts Building		\$ 6,500,000.00					
20		New ROTC Building		\$ 900,000.00					
21		New Science Building		\$ 2,700,000.00					
22									
23	5 5th High School								
24		Building		\$ 60,000,000.00					
25	6 Edinburg North High School								
26		Office Renovation		\$ 600,000.00					
27									
28	7 Economedes								
29		New ROTC Building		\$ 900,000.00					
30		Weight Room Renovation		\$ 300,000.00					
31		Ag Shop Addition		\$ 760,000.00					
32									
33	8 Austin								
34		Renovate Music & Cafeteria		\$ 250,000.00					
35									
36	9 Brewster								
37		Phase I Cafeteria Addition							
38		Phase II Gym/Classroom Addition	\$ 5,000,000.00						
39		Phase III Main Building Renovation		\$ 3,000,000.00					
40									
41	10 Freddy Gonzales								
42		Classroom Renovations		\$ 1,500,000.00					
43									
44	11 Hargill								
45		Classroom Renovations		\$ 1,622,500.00					
46									
47	12 Robert E. Lee								
48		Classroom Renovations		\$ 1,500,000.00					
49									
50	13 L.B. Johnson								
51		Classroom Renovations		\$ 1,500,000.00					
52									
53	14 Monte Cristo								

A	B	C	D	E	F	G	H	I	J
1	ECISD 2010 FACILITY NEEDS ASSESSMENT								
2	September								
3	Campus	Description	2008 Bond	Future Bond	PROPOSED BUDGET 2010-2011	PROPOSED BUDGET 2011-2012	PROPOSED BUDGET 2012-2013	PROPOSED BUDGET 2013-2014	PROPOSED BUDGET 2014-2015
54		Classroom Renovations		\$ 1,600,000.00					
55									
56	15 San Carlos	Classroom Renovations			\$ 375,000.00				
57									
58									
59	16 Academy	New Facility		\$ 2,750,000.00					
60		Renovate Sam Houston		\$ 3,500,000.00					
61									
62									
63	17 Career Technology	Classroom Renovations/Barrientes		\$ 2,300,000.00					
64		Classroom Renovations/South		\$ 1,750,000.00					
65		Ag Farm Addition		\$ 1,500,000.00					
66									
67									
68	18 Administration	Renovate Industrial Arts Building		\$ 2,500,000.00					
69									
70									
71	19 Transportation	Phase I							
72		Bay Wash Addition							
73		Phase II							
74		Mechanic Shop additions			\$ 1,200,000.00				
75	20 Maintenance and Facilities	Implement / Equipment Canopy					\$ 75,000.00		
76									
77									
78	21 Fixed Assets	Warehouse Renovation					\$ 750,000.00		
79		Old shop abatement			\$ 200,000.00				
80									
81									
82	22 Stadium	Master plan							\$ 25,000.00
83									
84									
85	23 District Miscellaneous Improvements	BL Garza							
86		San Carlos			\$ 100,000.00				
87		Canopy to Student drop-off					\$ 350,000.00		
88		Fire Sprinkler System					\$ 50,000.00		
89		Canopy							
90		Canopy to Student drop-off			\$ 75,000.00				
91		Canopy to Student drop-off					\$ 50,000.00		
92		Canopy to Student drop-off			\$ 75,000.00				
93		Canopy to Student drop-off			\$ 75,000.00				
94		Playground surface					\$ 100,000.00	\$ 100,000.00	\$ 100,000.00
95		Chemical Storage					\$ 50,000.00	\$ 50,000.00	
96	24 District Stage Additions								
97		F. Gonzales			\$ 80,000.00				
98		Canterbury					\$ 150,000.00		
99		LB, J							
100									
101	25 District Roofing Improvements								
102		Cavazos			\$ 150,000.00				
103		Irevino					\$ 125,000.00		

A	B	C	D	E	F	G	H	I	J
1	ECISD 2010 FACILITY NEEDS ASSESSMENT								
2	September								
3	Campus	Description	2008 Bond	Future Bond	PROPOSED BUDGET 2010-2011	PROPOSED BUDGET 2011-2012	PROPOSED BUDGET 2012-2013	PROPOSED BUDGET 2013-2014	PROPOSED BUDGET 2014-2016
104	Maintenance / Food Service								
105	JFK				\$ 225,000.00		\$ 150,000.00		
106	Escandon							\$ 150,000.00	
107	Truman							\$ 150,000.00	
108	Eisenhower								
109	Edinburg North								\$ 100,000.00
110	Canterbury								\$ 150,000.00
111									
112	26 District Paving Improvements						\$ 100,000.00		
113	DeLa Vina								
114	Robert E. Lee	Repave Parking Lots & Drives			\$ 220,000.00				
115	Villarreal	Repave Parking Lots & Drives					\$ 100,000.00		
116	Monte Cristo	Repave Parking Lots & Drives					\$ 175,000.00		
117	Escandon	Parking Lot Addition				\$ 175,000.00			
118	Truman	Parking Lot Addition				\$ 175,000.00			
119	Guerra	Parking Lot Addition				\$ 175,000.00			
120	Operation Complex Paving								
121		Phase I							
122		Phase II					\$ 350,000.00		
123		Phase III							
124									
125	27 District Parking Lot Lighting								
126	Canterbury					\$ 50,000.00			
127	DeLa Vina				\$ 50,000.00				
128	LBJ						\$ 75,000.00		
129	Travis							\$ 75,000.00	
130									
131	28 District Lawn Sprinkler Systems								
132	Villarreal	New Irrigation sprinkler system				\$ 25,000.00			
133	Betts	New Irrigation sprinkler system				\$ 25,000.00			
134	Guerra	New Irrigation sprinkler system							
135	Hargill	New Irrigation sprinkler system			\$ 25,000.00				
136	Montecristo	New Irrigation sprinkler system					\$ 25,000.00		
137	San Carlos	New Irrigation sprinkler system					\$ 25,000.00		
138	Trevino	New Irrigation sprinkler system			\$ 25,000.00				
139	Zavala	New Irrigation sprinkler system					\$ 25,000.00		
140	Austin	New Irrigation sprinkler system					\$ 10,000.00		
141									
142									
143									
			\$ 110,700,000.00	\$ 169,722,500.00	\$ 1,000,000.00	\$ 2,650,000.00	\$ 2,725,000.00	\$ 535,000.00	\$ 575,000.00
		Total Budget							



EXHIBIT _____



EXHIBIT _____

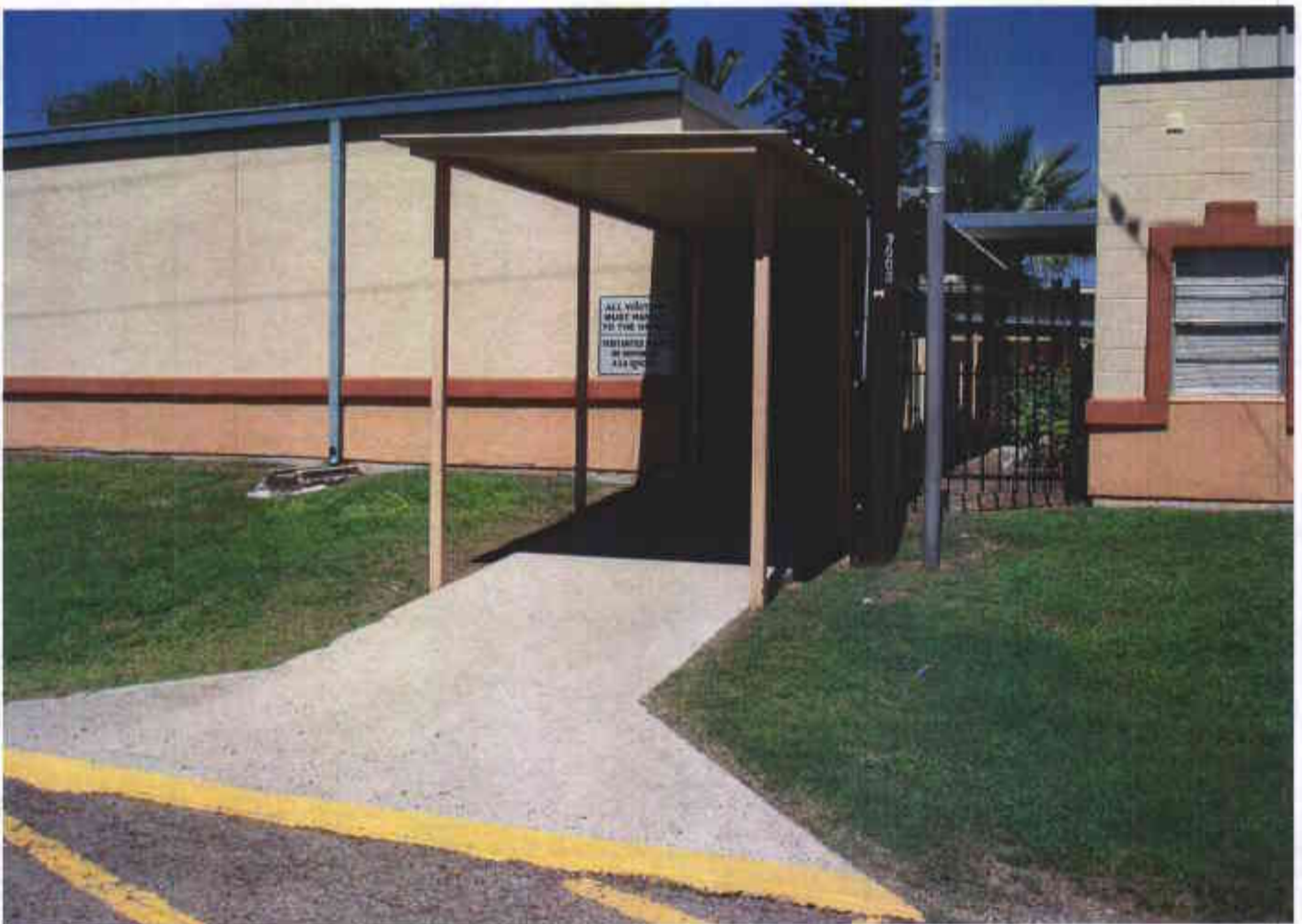

EXHIBIT _____



EXHIBIT _____



EXHIBIT _____

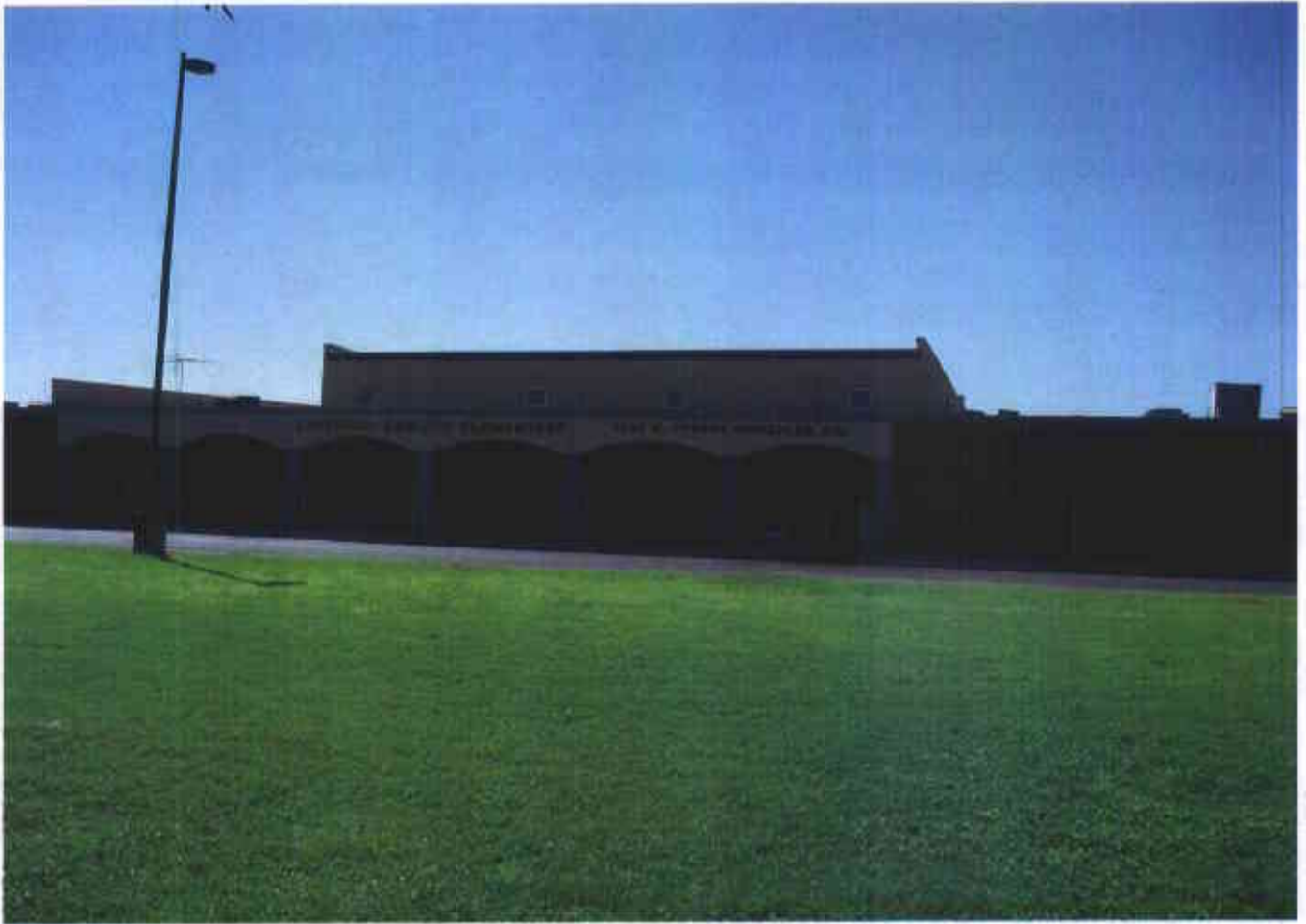

EXHIBIT _____



EXHIBIT



EXHIBIT _____



EXHIBIT _____



EXHIBIT _____

APPROVAL OF MACARIA GORENA ELEMENTARY SCHOOL UTILITY EASEMENT

Superintendent's Recommendation

That the Board of Trustees approves Macaria Gorena Elementary School Utility Easement as prepared by Broaddus & Associates.

Rationale

Broaddus and Associates respectfully submit for your consideration a request for the dedication of a utility easement for the project referred to above. This easement is required per a request by AT&T in order to properly service the newly installed telephone line for the new elementary school. The easement will also be available for use by utility companies other than AT&T if the need arises.

Broaddus and Associates requests the Board of Trustees accept the proposed utility easement as described in the attached documents prepared by Rio Delta Engineering.

The Facilities Committee has reviewed this item and recommends Board approval.

Budgetary Information

Account Number	Appropriation	Encumbrance	Expenditure	Balance
N/A				

Resource Personnel

Facilities Committee
 Gilberto Garza, Jr.
 Mario Salinas
 Sylvia Garcia
 Robert Estrada

Board Policy Reference

This is in accordance with Board Policy CVB (Legal) Facilities Construction:

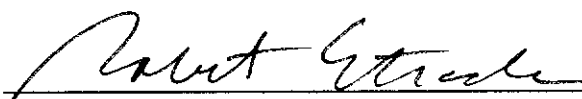
Prepared by: 
 Robert Estrada, District Architect

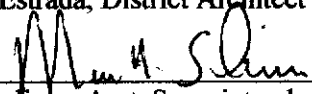
Approved by: 
 Mario Salinas, Asst. Superintendent for District Administration

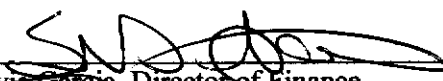
Within Budgetary Allocations: 
 Sylvia Garcia, Director of Finance

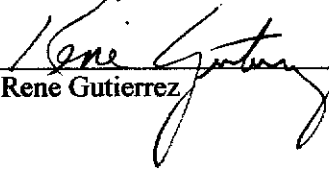
Superintendent: 
 Dr. Rene Gutierrez

**BROADDUS
& ASSOCIATES**
Facilities Project Management and Consulting

11/04/2010

Dr. Rene Gutierrez, Ed.D.
Superintendent of Schools
Edinburg Consolidated Independent School District
411 N. 8th St.
Edinburg, TX 78541

Re: ECISD 2008 Bond Program
Utility Easement Dedication
Gorena Elementary School ES #31

Dear Mr. Gutierrez:

Broaddus & Associates respectfully submits for your consideration a request for the dedication of a utility easement for the project referred to above. This easement is required per a request by AT&T in order to properly service the newly installed telephone line for the new elementary school. The easement will also be available for use by utility companies other than AT&T if the need arises.

Broaddus & Associates requests that the Facilities Committee consider recommending to the ECISD Board of Trustees the acceptance of the proposed utility easement as described in the attached documents prepared by Rio Delta Engineering. Please contact me if you have any questions or if you require any additional information.

Sincerely,

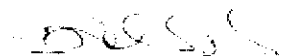

Rolando L. Garcia, FAIA
Senior Project Manager, LEED AP

FN: 101104 ECISD Gorena ES Easement Recom Let.docx

1100 E. Jasmine Ave. ◊ McAllen, Texas 78501 ◊ Phone: (956) 688-2307 ◊ Fax: (956) 688-2315

1301 S. Capital of Texas Highway, Suite A-302 ◊ Austin, Texas 78746 ◊ Phone: (512) 329-8822 ◊ Fax: (512) 329-8242

EXHIBIT _____

EXHIBIT "B"
 TO ACCOMPANY FIELD
 NOTES FOR
 UTILITY EASEMENT

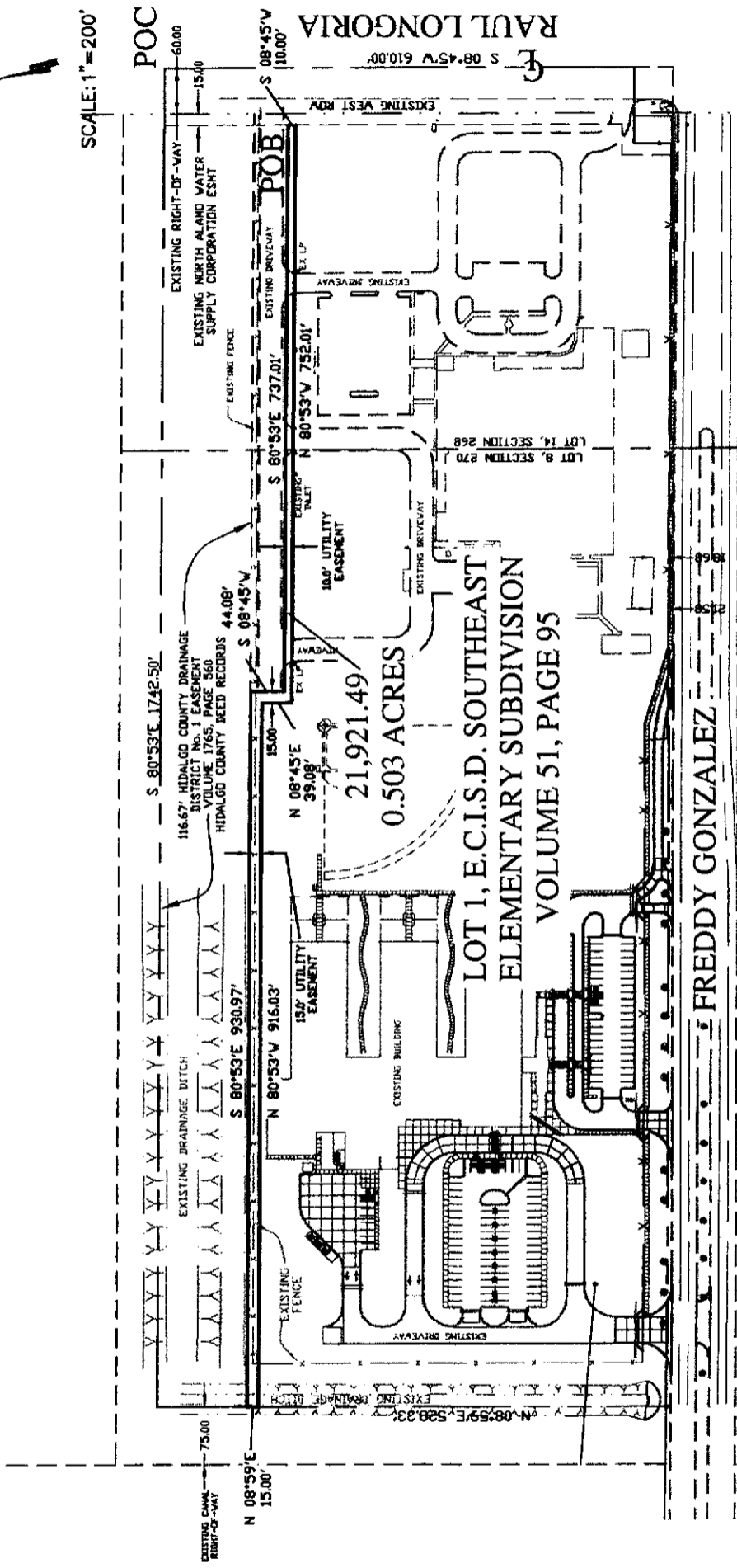

SCALE: 1" = 200'

POC

RAUL LONGORIA

21,921.49
 0.503 ACRES

LOT 1, E.C.I.S.D. SOUTHEAST
 ELEMENTARY SUBDIVISION
 VOLUME 51, PAGE 95

FREDDY GONZALEZ

METES AND BOUNDS
 DESCRIPTION AND EXHIBIT
 PRODUCED FROM
 RECORDED PLAT

DATE OF PREPARATION: OCT 18, 2010

EXHIBIT

**EXHIBIT A
UTILITY EASEMENT
0.503 ACRES**

BEING A CERTAIN 0.503 ACRE TRACT OF LAND OUT OF LOT 8, SECTION 270, AND LOT 14, SECTION 268, TEXAS-MEXICAN RAILWAY COMPANY SURVEY, HIDALGO COUNTY, TEXAS, AS PER MAP RECORDED IN VOLUME 24, PAGES 170-171, DEED RECORDS HIDALGO COUNTY, TEXAS, SAME BEING OUT OF LOT 1, E.C.I.S.D. SOUTHEAST ELEMENTARY SUBDIVISION, AS RECORDED IN VOLUME 51, PAGE 95, OF THE MAP RECORDS OF HIDALGO COUNTY, TEXAS, SAID 0.503 ACRES BEING MORE PARTICULARLY DESCRIBED BY METES AND BOUNDS AS FOLLOWS;

BEGINNING AT THE NORTHEAST CORNER OF SAID LOT 1, OF SAID SUBDIVISION, SAME BEING A POINT IN THE CENTERLINE OF RAUL LONGORIA ROAD;

THENCE N 80°53' W ALONG THE NORTH LINE OF SAID LOT 1 A DISTANCE OF 75.0 FEET TO A CALCULATED POINT ON THE NORTH LINE OF SAID LOT 1 AND SAME BEING A POINT ON THE WEST LINE OF A 15.0 FOOT EASEMENT TO NORTH ALAMO WATER SUPPLY CORPORATION AS SHOWN IN THE RECORDED SUBDIVISION PLAT;

THENCE S 08°45' W ALONG THE WEST LINE OF SAID EASEMENT A DISTANCE OF 160.28 FEET TO A CALCULATED POINT AND THE NORTHEAST CORNER OF THE HEREIN DESCRIBED TRACT AND THE **PLACE OF BEGINNING**;

THENCE S 08°45' W CONTINUING ALONG THE WEST LINE OF SAID EASEMENT A DISTANCE OF 10.0 FEET TO CALCULATED POINT ON THE WEST LINE OF SAID EASEMENT AND THE SOUTHEAST CORNER OF THE HEREIN DESCRIBED TRACT;

THENCE N 80°53' W, ACROSS AND PARALLEL TO THE NORTH LINE OF SAID LOT 1, A DISTANCE OF 752.01 FEET TO A CALCULATED POINT FOR AN EXTERIOR CORNER OF THE HEREIN DESCRIBED TRACT;

THENCE N 08°45' E, PARALLEL THE EAST LINE OF SAID LOT 1, A DISTANCE OF 39.08 FEET TO A CALCULATED POINT FOR AN INTERIOR CORNER OF THE HEREIN DESCRIBED TRACT;

THENCE N 80°53' W, PARALLEL THE NORTH LINE OF SAID LOT 1, A DISTANCE OF 916.03 FEET TO A CALCULATED POINT ON THE WEST LINE OF THE SAID LOT 1 AND SAME BEING THE SOUTHWEST CORNER OF THE HEREIN DESCRIBED TRACT;

THENCE N 08°59' E ALONG THE WEST LINE OF SAID LOT 1 A DISTANCE OF 15.0 FEET TO A CALCULATED POINT ON THE WEST LINE OF SAID LOT 1, SAME POINT BEING THE NORTHWEST CORNER OF THE HEREIN DESCRIBED TRACT;

THENCE S 80°53' E, ACROSS AND PARALLEL THE NORTH LINE OF SAID LOT 1, A DISTANCE OF 930.97 FEET TO A CALCULATED POINT FOR AN EXTERIOR CORNER OF THE HEREIN DESCRIBED TRACT;

THENCE S 08°45' W, PARALLEL THE EAST LINE OF SAID LOT 1, A DISTANCE OF 44.08 FEET TO A CALCULATED POINT FOR AN INTERIOR CORNER OF THE HEREIN DESCRIBED TRACT;

THENCE S 80°53' E, PARALLEL THE NORTH LINE OF SAID LOT 1, A DISTANCE OF 737.01 FEET TO THE POINT AND PLACE OF BEGINNING, SAID TRACT CONTAINING 0.503 ACRES OF LAND, MORE OR LESS.

EXHIBIT "A" AND EXHIBIT "B", PRODUCED FROM THE RECORDED PLAT RECORDED IN VOLUME 51, PAGE 95, AND NOT FROM AN ON THE GROUND SURVEY. THE EASEMENT LIES WHOLLY WITHIN LOT 1 OF THE RECORDED SUBDIVISION. THESE FIELD NOTES TO BE USED ONLY IN CONJUNCTION WITH THE ATTACHED EXHIBIT "B".

James W. Griffith

10/20/10

JAMES W. GRIFFITH

DATE

REGISTERED PROFESSIONAL LAND SURVEYOR NO. 1885

GRIFFITH CONSULTING

SURVEY FIRM NO. 101699-00



EXHIBIT _____

**APPROVAL OF GROUP E - ROBERT VELA HIGH SCHOOL
MILNET ARCHITECTURAL SERVICES CONTRACT
AMENDMENT**

Superintendent's Recommendation

That the Board of Trustees approves the Group E – Robert Vela High School Milnet Architectural Services Contract Amendment as prepared by Broaddus & Associates.

Rationale

Attached is a revised projection of the proposed costs for the renovations of the existing Harwell Campus in order to convert it to the Robert Vela High School. Broaddus and Associates respectfully request that the ECISD Board of Trustees consider approval of the proposed increase in the Architect's fee based on the revised projections. Approval of this increase will allow the Architect to proceed with the necessary design and documentation for the project.

Per the attachment, the original project construction budget of \$900,000 would increase to \$3,683,339 and the corresponding A/E fee would increase by \$212,125 from \$64,125 to \$276,250. Broaddus and Associates believe that this adjustment to the Architect's fee is fair and reasonable.

The Facilities Committee has reviewed this item and recommended Board approval.

Budgetary Information

Account Number	Appropriation	Encumbrance	Expenditure	Balance
623-81-6216-00-006-099	\$469,370.00	\$ 78,162.50	\$ 0.00	\$391,207.50

Resource Personnel

Facilities Committee	Dr. Rene Gutiérrez
Mario Salinas	Sylvia Garcia
Robert Estrada	

Board Policy Reference

This is in accordance with Board Policy BAA (Legal) Board Powers and Duties.

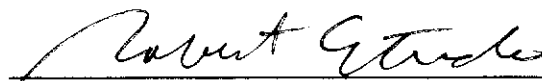
Prepared by: 
Robert Estrada, District Architect

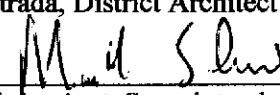
Approved by: 
Mario Salinas, Asst. Superintendent for District Administration

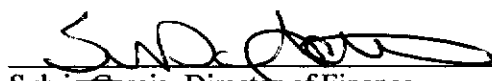
Within Budgetary Allocations: 
Sylvia Garcia, Director of Finance

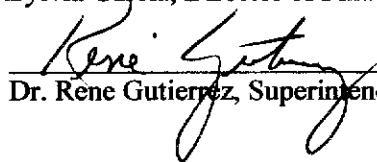
Recommended by: 
Dr. Rene Gutierrez, Superintendent of Schools

**BROADDUS
& ASSOCIATES**
Financial Project Management and Consulting

11/17/2010

Dr. Rene Gutierrez, Ed.D.
Superintendent of Schools
Edinburg Consolidated Independent School District
411 N. 8th St.
Edinburg, TX 78541

Re: ECISD 2008 Bond Program
Robert Vela High School (Harwell) Campus Renovations
Revisions to Project Budget and Architect's Agreement

Dear Mr. Gutierrez:

Attached is a revised projection of the proposed costs for the renovations of the existing Harwell Campus in order to convert it to the Robert Vela High School. Broaddus & Associates respectfully request the ECISD Board of Trustees consider approval of the proposed increase in the Architect's fee based on the revised projections. Approval of this increase will allow the Architect to proceed with the necessary design and documentation for the project.

Per the attachment, the original project construction budget of \$900,000 would increase to \$3,683,339 and the corresponding A/E fee would increase by \$212,125, from \$64,125 to \$276,250. Broaddus & Associates believes that this adjustment to the Architect's fee is fair and reasonable.

Please contact me if you have any questions or if you require any additional information.

Sincerely,



Rolando L. Garcia, FAIA
Senior Project Manager, LEED AP
FN: 101117 ECISD RVHS Renovs Board Recom Let.docx

1100 E. Jasmine Ave. ♦ McAllen, Texas 78501 ♦ Phone: (956) 688-2307 ♦ Fax: (956) 688-2315

1301 S. Capital of Texas Highway, Suite A-302 ♦ Austin, Texas 78746 ♦ Phone: (512) 329-8822 ♦ Fax: (512) 329-8242

**ECISD 2008 Bond Program
Available Funds Status
11/10/10**

Project Group	Project Cost	Design Contingency	Owner Contingency	Projected Savings	Total
Elementary Schools	\$ 35,000,000	\$ 83,858	\$ 542,040	\$ 727,324	\$ 1,353,222
Middle Schools	\$ 38,768,651	\$ 298,020	\$ 291,907	\$ 397,583	\$ 987,510
Fine Arts	\$ 18,466,256	\$ 5,553	\$ 1,760	\$ -	\$ 7,313
Brewster Campus Additions	\$ 4,515,518	\$ -	\$ -	\$ -	\$ -
R. Vela HS Campus Renovations	TBD	\$ -	\$ -	\$ -	TBD
Bond Project Savings Sub-Total					
Bond Funds - Interest Earned	\$ -	\$ -	\$ -	\$ -	\$ 2,348,045
OCIP Savings	\$ -	\$ -	\$ -	\$ -	\$ 1,177,000
Other Bond Project Savings	\$ -	\$ -	\$ -	\$ -	\$ 250,000
Totals	\$ 96,750,425	\$ 387,431	\$ 835,707	\$ 1,124,907	\$ 3,775,045

Total Project Savings Funds Available \$ 2,348,045

Recommendation:

Assign funds to RVHS Renovations from the following sources:

Description	2008 Bond Budget	Bond Interest	Available Funds	Totals
Priority A			\$ 1,355,000	\$ 1,355,000
Priority B		\$ 1,052,464		\$ 1,052,464
Priority C			\$ 810,875	\$ 810,875
Priority D			\$ 465,000	\$ 465,000
Total	\$ -	\$ 1,052,464	\$ 2,630,875	\$ 3,683,339

Total Project Probable Cost	\$ 3,683,339
From Bond Budget	\$ (900,000)
From Bond Interest	\$ 2,783,339
Req'd From Available Bond Funds	\$ (1,052,464)
	\$ 1,730,875

Total Available Funds	\$ 2,348,045
Req'd From Available Bond Funds	\$ (1,730,875)
Available Funds Balance	\$ 617,170
Additional AE Fees	\$ (212,125)
Cost for Fine Arts AV Alternates	\$ (324,204)
Savings Balance	\$ 80,841

EXHIBIT

ADDITIONAL SERVICES PROPOSAL #01

November 17, 2010

Rodolfo Molina, AIA, Principal
Milnet Architectural Services
608 S. 12th St.
McAllen, TX 78501
(956) 688-5656

RE: ECISD 2008 Bond Program
Robert Vela High School (Harwell) Campus Renovations
Revisions to Project Budget and Architect's Agreement

Gentlemen:

Please refer to the Agreement dated November 12, 2008 between Edinburg Consolidated Independent School District ("Owner") and the undersigned ("Architect") as amended to the date hereof (such agreement as so modified and amended being hereafter called the "Agreement") pursuant to which Project Architect is to perform certain services. The terms which are defined in the Agreement shall have the same meanings when used in this letter.

1. Owner has requested the performance of the services described below which Project Architect deems to be Additional Services.

(Refer to attached exhibit)
2. Project Architect agrees to perform the Additional Services described above subject to and in accordance with the terms and provisions of the Agreement for a fee which will be determined in accordance with the Agreement but which will not exceed two hundred twelve thousand one hundred twenty-five Dollars (\$212,125.00) and for reimbursement of expenses in accordance with the Agreement, incurred solely in connection with the performance of such Additional Services.
3. Project Architect will perform the service in accordance with the schedule. The schedule will be adjusted to reflect the date that the Architect is authorized to proceed.

If the foregoing is acceptable to you, please so execute by signing this letter at the space provided for this purpose.

Original Contract Amount	\$64,125.00
Previous Additions	0.00
Previous Deductions	0.00
Net Balance Contract Amount	<u>\$64,125.00</u>
This Addition	212,125.00
Adjusted Contract Amount	<u>\$276,250.00</u>

Milnet Architectural Services

By:

Name: Rodolfo Molina, AIA

Title: Principal



MILNET ARCHITECTURAL SERVICES
608 SOUTH 12TH ST.
McALLEN, TEXAS 78501

ADDITIONAL SERVICES PROPOSAL #01

November 15, 2010

Rodolfo Molina, AIA, Principal
Milnet Architectural Services
608 S. 12th St.
McAllen, TX 78501
(956) 688-5656

RE: ECISD 2008 Bond Program
Robert Vela High School (Harwell) Campus Renovations
Revisions to Project Budget and Architect's Agreement

Gentlemen:

Please refer to the Agreement dated November 12, 2008 between Edinburg Consolidated Independent School District ("Owner") and the undersigned ("Architect") as amended to the date hereof (such agreement as so modified and amended being hereafter called the "Agreement") pursuant to which Project Architect is to perform certain services. The terms which are defined in the Agreement shall have the same meanings when used in this letter.

1. Owner has requested the performance of the services described below which Project Architect deems to be Additional Services.

(Refer to attached exhibits)

2. Project Architect agrees to perform the Additional Services described above subject to and in accordance with the terms and provisions of the Agreement for a fee which will be determined in accordance with the Agreement but which will not exceed two hundred seventy-six thousand two hundred fifty Dollars (\$276,250.00) and for reimbursement of expenses in accordance with the Agreement, incurred solely in connection with the performance of such Additional Services.
3. Project Architect will perform the service in accordance with the schedule attached hereto. The schedule will be adjusted to reflect the date that the Architect is authorized to proceed.

If the foregoing is acceptable to you, please so execute by signing this letter at the space provided for this purpose.

Milnet Architectural Services

By: 

Name: Rodolfo Molina, AIA
Title: Principal

Edinburg Consolidated Independent School District

By:

Name: Dr. Rene Gutierrez, Ed.D.
Title: Superintendent of Schools

ECISD 2008 Bond Program
Robert Vela (Harwell) Campus Renovations
Prioritized Master List of Proposed Renovations
 05/27/2010

Priority	Description	Quantity	Unit	Unit Cost	Priority A	Priority B	Priority C	Priority D	Total	Remarks
A	Science Lab Renovations	13,600	SF	\$ 50.00	\$ 680,000				\$ 680,000	Includes Science Lab Equipment in renovation cost
A	Football Field	1	LS	\$230,000.00	\$ 230,000				\$ 230,000	Includes 150 seat bleacher section
A	Track	1	LS	\$175,000.00	\$ 175,000				\$ 175,000	
A	Baseball Field	1	LS	\$125,000.00	\$ 125,000				\$ 125,000	Flipped & modernized. Includes 150 seat bleacher section
A	Softball Field	1	LS	\$100,000.00	\$ 100,000				\$ 100,000	Includes 150 seat bleacher section
A	Band Practice Field	1	LS	\$ 45,000.00	\$ 45,000				\$ 45,000	Includes field dressing and Band Dir. tower relocation
B	Field Events	1	LS	\$ 75,000.00		\$ 75,000			\$ 75,000	
B	Press Box	368	SF	\$ 85.00		\$ 31,280			\$ 31,280	3 Press Boxes @ \$10,426 ea.
B	Lighting: Football Field	1	LS	\$161,000.00		\$ 161,000			\$ 161,000	
B	Add Bleachers: Football Field	250	Seat	\$ 100.00		\$ 25,000			\$ 25,000	Home seating bleachers
B	Lighting: Baseball Field	1	LS	\$175,000.00		\$ 175,000			\$ 175,000	
B	Add Bleachers: Baseball Field	150	Seat	\$ 100.00		\$ 15,000			\$ 15,000	Home seating bleachers
B	Lighting: Softball Field	1	LS	\$ 92,684.00		\$ 92,684			\$ 92,684	
B	Add Bleachers: Softball Field	75	Seat	\$ 100.00		\$ 7,500			\$ 7,500	Home seating bleachers
B	Dugouts and storage	4	LS	\$ 25,000.00		\$ 100,000			\$ 100,000	
B	Tennis courts upgrades and light	2	LS	\$ 60,000.00		\$ 120,000			\$ 120,000	
B	Restroom / Storage - Athletics	2	LS	\$125,000.00		\$ 250,000			\$ 250,000	per Brewster Campus additions
C	Add Ag welding booths	1	LS	\$100,000.00			\$ 100,000		\$ 100,000	
C	HVAC Controls upgrade	1	LS	\$ 90,000.00			\$ 90,000		\$ 90,000	
C	Asbestos abatement	1	LS	\$120,000.00			\$ 120,000		\$ 120,000	
C	Drainage Fill & Grading	1,000	CY	\$ 34.00			\$ 34,000		\$ 34,000	
C	New Sidewalks - Fields	7,750	SF	\$ 8.50			\$ 65,875		\$ 65,875	
C	Practice Gym Flooring Pad	1	LS	\$ 25,000.00			\$ 25,000		\$ 25,000	
C	Caulk & Seal Building Envelope	240,000	SF	\$ 0.15			\$ 36,000		\$ 36,000	
C	Maintenance assessment request	1	LS	\$150,000.00			\$ 150,000		\$ 150,000	
D	Maintenance assessment request	1	LS	\$830,000.00				\$ 830,000	\$ 830,000	
D	Terrazo	35,850	SF	\$ 15.00				\$ 537,750	\$ 537,750	
D	Painting	500,000	SF	\$ 0.56				\$ 280,000	\$ 280,000	
D	Parking lots Repair and Re-seal	264,000	SF	\$ 4.00				\$ 1,056,000	\$ 1,056,000	Includes stripping
D	Roofing: Replace	240,000	SF	\$ 12.00				\$ 2,880,000	\$ 2,880,000	Out of warranty in 2011. Replacement in 2 - 5 years
D	New Fine Arts Building	1	1	\$ 6,165.00				\$ 6,165,000	\$ 6,165,000	
D	New Science Wing Addition	18,000	SF	\$ 150.00				\$ 2,700,000	\$ 2,700,000	
				TOTALS:	\$ 1,355,000	\$ 1,052,464	\$ 620,875	\$ 14,448,750	\$ 17,477,089	
	Priority A = 2008 Bond Program Budgeted			Original Budgeted Amount	\$ 900,000					
	Priority B = Non-IFA Item			Priority Items A	\$ 1,355,000					
	Priority C = Project Necessity			Priority Items B	\$ 1,052,464					
	Priority D = Project Betterment			Priority Items C	\$ 620,875					
				Unfunded Balance	\$ (2,128,339)					

APPROVAL OF CHANGE ORDER #2 FOR GROUP C – FINE ARTS FACILITIES

Superintendent's Recommendation

That the Board of Trustees approves the Change Order #2 for Group C Fine Arts Facilities Project as prepared by Broaddus & Associates.

Rationale

Broaddus and Associates has reviewed the proposed change request submitted by Construction Manager at Risk (CMR) SpawGlass Contractors, Inc. for a reduction to the GMP for the Owner Controlled Insurance Program (OCIP). The original Guaranteed Maximum Price (GMP) of \$18,501,256 will be reduced by an additional \$16,144.00. The revised GMP will be \$18,431,482.

Original GMP	\$18,501,256.00
Change Order #1 – OCIP Contribution/Time	\$ (53,630.00)
Change Order #2 – Miscellaneous Items	\$ (16,144.00)
Construction Contingency Balance	\$18,431,482.00

Broaddus and Associates has also reviewed the proposed change request for additional construction days caused by rain delays. The original date established for Substantial Completion was September 14, 2010. The revised Substantial Completion date per Change Order #1 was November 6, 2010. The CMR and Broaddus and Associates have agreed to a total of 24 additional acceptable rain delays days. The new revised Substantial Completion date will be November 30, 2010. There will be no additional cost to the contract price as a result of the change in Substantial Completion date.

Broaddus and Associates finds the proposed costs reduction and the additional construction delay days to be fair and reasonable and respectfully requests that the ECISD Board of Trustees consider recommending approval of this credit to the GMP.

The Facilities Committee has reviewed this item and recommended Board approval.

Budgetary Information

Account Number	Appropriation	Encumbrance	Expenditure	Balance
623-81-6629-00-001-199	\$ 2,039,444.00	\$1,047,262.71	\$959,953.14	\$ 32,228.15
623-81-6629-00-002-199	\$1,386,317.00	\$ 607,593.64	\$739,368.13	\$ 39,355.23
623-81-6629-00-003-199	\$1,449,945.00	\$ 436,709.65	\$982,688.73	\$ 30,546.62

Resource Personnel

Facilities Committee	Dr. Rene Gutiérrez
Mario Salinas	Sylvia Garcia
Robert Estrada	

Board Policy Reference

This is in accordance with Board Policy BAA (Legal) Board Powers and Duties.

Prepared by:

Robert Estrada, District Architect

Approved by:

Mario Salinas, Asst. Superintendent for District Administration

Within Budgetary Allocations:

Sylvia Garcia, Director of Finance

Recommended by:



Dr. Rene Gutierrez, Superintendent of Schools

Exhibit _____, Pages _____

**BROADDUS
& ASSOCIATES**
INTEGRATED PROJECT MANAGEMENT AND CONSULTING

11/17/2010

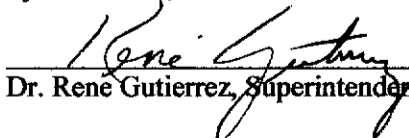
Dr. Rene Gutierrez, Ed.D.
Superintendent of Schools
Edinburg Consolidated Independent School District
411 N. 8th St.
Edinburg, TX 78541

Re: ECISD 2008 Bond Program
New Fine Arts Facilities – ENHS, JEHS, & EHS
Change Order # 02

Dear Mr. Gutierrez:

Broaddus & Associates has reviewed the proposed change request submitted by Construction Manager-at-Risk (CMR) SpawGlass Contractors, Inc. for a reduction to the GMP for the Owner Controlled Insurance Program (OCIP). The original Guaranteed Maximum Price (GMP) of \$18,501,256 will be reduced by an additional \$16,144.00. The revised GMP will be \$18,431,482.

Description	Amount
Original GMP	\$18,501,256
Change Order #01 – OCIP Contribution/Time	(53,630)
Change Order #02 – OCIP Contribution/Time	(16,144)
Revised GMP	\$18,431,482

Broaddus & Associates has also reviewed the proposed change request for additional construction days caused by rain delays. The original date established for Substantial Completion was September 14, 2010. The revised Substantial Completion date per Change Order #1 was November 06, 2010. The CMR and Broaddus & Associates have agreed to a total of 24 additional acceptable rain delay days. The new revised Substantial Completion date will be November 30, 2010. There will be no additional cost to the contract price as a result of the change in substantial completion date.

Based on our review, Broaddus & Associates finds the proposed costs reduction and the additional construction delay days to be fair and reasonable and respectfully requests that the Facility Committee consider recommending approval to the Board of Trustees of this credit to the GMP.

Please contact me if you have any questions or if you require any additional information.

Sincerely,



Rolando L. Garcia, FAIA
Senior Project Manager, LEED AP

FN: 101117 ECISD FA Change Order 02 Recom Let.docx

1100 E. Jasmine Ave. ♦ McAllen, Texas 78501 ♦ Phone: (956) 688-2307 ♦ Fax: (956) 688-2315

1301 S. Capital of Texas Highway, Suite A-302 ♦ Austin, Texas 78746 ♦ Phone: (512) 329-8822 ♦ Fax: (512) 329-8242

EXHIBIT _____

Change Order (For CM/R, D/B and Performance Contracts)

Project Name: ECISD 2008 Bond Fine Arts Facilities Change Order No.: 2
 Project No.: 09003 Date: November 11, 2010
 Location: JEHS, ENHS, EHS

This Change Order Impacts Phase II Services

To: SpawGlass Contractors, Inc., Contractor for the above project;
 You are hereby authorized to make the following changes in the work under your contract:

C.P./F.O. No.	Description of Work	Cost	Time Extension
1	Adjust contract completion dates	0	24 days
	OCIP and returned contingencies credit	(\$16,144.00)	0 days

It is agreed that the _____ cost ~~XXXXX~~ credit of **Sixteen Thousand, One Hundred Forty-Four dollars (\$16,144.00)** and 24 days Time extension provided

For in this Change Order, constitutes full compensation to the Contracting Firm (CM/R, D/B, Performance Contractor), whether direct, consequential or otherwise, in any wise incident to, or arising out of, or resulting directly from the work performed or modified by the Contracting Firm under this Change Order. The Contract completion date, including this time extension if any, is Original Notice To Proceed was granted September 29, 2009 with a 12-month duration until Substantial Completion. 38 rain days carried the Substantial Completion Date to November 6, 2010 for all buildings, granted 8-31-2010. Additional rain and delay days now bring the Substantial Completion date to November 30, 2010.

For the above changes the sum of; \$16,144.00
 will be: _____ added to, xxxx deducted from, the contract price.

Original Part <u>II</u> Services Amt. OR Contingency Allowance	(\$ <u>18,501,256.00</u>)	Accepted:
Previous Additions	(\$ <u>0</u>)	
Previous Deductions	(\$ <u>53,630.00</u>)	By: _____
Net Bal. Part <u>II</u> Services Amount OR Contingency Allowance	(\$ <u>18,447,626.00</u>)	SpawGlass Contractors, Inc.
This ADDITION	(\$ <u>0</u>)	
This DEDUCTION	(\$ <u>16,144.00</u>)	By: _____
Adjusted Part <u>II</u> Services Amount OR Contingency Allowance Balance	(\$ <u>18,431,482.00</u>)	Broaddus & Associates
Summary of Other Services Total:		By: _____
Part <u>I</u> Services Amount	(\$ <u>0</u>)	ERO Architects, Inc.
Part <u>II</u> Services Amount	(\$ <u>0</u>)	E.C.I.S.D.
Total Adjusted Contract	(\$ <u>18,431,482.00</u>)	

**BROADDUS
& ASSOCIATES
EXHIBIT**

**APPROVAL OF CONSTRUCTION CONTINGENCY
AUTHORIZATION 4 FOR GROUP C FINE ARTS FACILITIES**

Superintendent's Recommendation

That the Board of Trustees approves the Construction Contingency Authorization 4 for Group C Fine Arts Facilities Project as prepared by Broaddus & Associates.

Rationale

Broaddus and Associates has reviewed the cost proposals submitted by Construction Manager at Risk (CMR) SpawGlass Contractors, Inc. for electrical, data, cat-walk and dumpster enclosure modifications. The original Owner Contingency amount of \$300,000 included in the GMP would be reduced by \$9,477 and the new remaining balance would be \$1,759.

Contingency Amount	\$300,000.00
Construction Contingency Expenditure Authorization 1	\$ 88,347.00
Construction Contingency Expenditure Authorization 2	\$176,792.00
Construction Contingency Expenditure Authorization 3	\$ 23,655.00
Construction Contingency Expenditure Authorization 3	\$ 9,477.00
Contingency Balance	\$ 1,759.00

Broaddus and Associates finds the proposed costs to be fair and reasonable and respectfully recommend that the Board consider approval of this expenditure from the Construction (Owner) Contingency.

The Facilities Committee has reviewed this item and recommended Board approval.

Budgetary Information

Account Number	Appropriation	Encumbrance	Expenditure	Balance
623-81-6629-00-001-199	\$ 2,039,444.00	\$1,047,262.71	\$959,953.14	\$ 32,228.15
623-81-6629-00-002-199	\$1,386,317.00	\$ 607,593.64	\$739,368.13	\$ 39,355.23
623-81-6629-00-003-199	\$1,449,945.00	\$ 436,709.65	\$982,688.73	\$ 30,546.62

Resource Personnel

Facilities Committee
Dr. Rene Gutiérrez
Mario Salinas
Sylvia Garcia
Robert Estrada

Board Policy Reference

This is in accordance with Board Policy BAA (Legal) Board Powers and Duties.

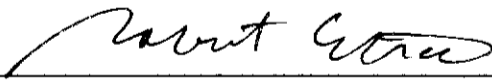
Prepared by: 
Robert Estrada, District Architect

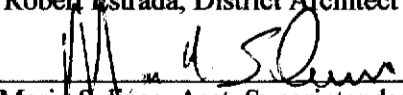
Approved by: 
Mario Salinas, Asst. Superintendent for District Administration

Within Budgetary Allocations: 
Sylvia Garcia, Director of Finance

Recommended by: 
Dr. Rene Gutierrez, Superintendent of Schools

Exhibit _____, Pages _____

**BROADDUS
& ASSOCIATES**
Facilities Project Management and Consulting

11/08/2010

Dr. Rene Gutierrez, Ed.D.
Superintendent of Schools
Edinburg Consolidated Independent School District
411 N. 8th St.
Edinburg, TX 78541

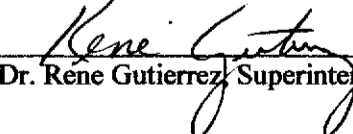
Re: ECISD 2008 Bond Program
New Fine Arts Facilities – ENHS, JEHS, & EHS
Proposed Electrical, Data, Cat Walk, & Dumpster Enclosure Modifications
Construction Contingency Expenditure Authorization #04

Dear Mr. Gutierrez:

Broaddus & Associates has reviewed the attached cost proposals submitted by Construction Manager at Risk (CMR) SpawGlass Contractors, Inc. for electrical, data, cat-walk and dumpster enclosure modifications. The original Owner Contingency amount of \$300,000 included in the GMP would be reduced by \$9,477 and the new remaining balance would be \$1,759.

Description	Amount
Construction Contingency	\$300,000.00
Construction Contingency Expenditure #01	88,347.00
Construction Contingency Expenditure #02	176,792.00
Construction Contingency Expenditure #03	23,655.00
Construction Contingency Expenditure #04	9,447.00
Construction Contingency Balance	\$1,759.00

Based on our review, Broaddus & Associates finds the proposed costs to be fair and reasonable and respectfully recommends that the Facility Committee consider recommending approval of this expenditure from the Construction (Owner) Contingency to the Board of Trustees.

Please contact me if you have any questions or if you require any additional information.

Sincerely,

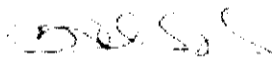

Rolando L. Garcia, FAIA
Senior Project Manager, LEED AP

FN: 101108 ECISD FA Expense Authorization 04 Recom Let.docx

1100 E. Jasmine Ave. ♦ McAllen, Texas 78501 ♦ Phone: (956) 688-2307 ♦ Fax: (956) 688-2315

1301 S. Capital of Texas Highway, Suite A-302 ♦ Austin, Texas 78746 ♦ Phone: (512) 329-8822 ♦ Fax: (512) 329-8242

EXHIBIT _____

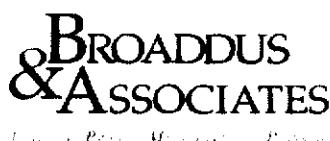

CONSTRUCTION CONTINGENCY EXPENDITURE AUTHORIZATION

NUMBER: 4
 DATE: 10/25/2010

PROJECT NAME: Fine Arts Facilities
 PROJECT NO.: 9003

To: SpawGlass Contractors, Inc.
4909 East Grimes, Suite 116
Harlingen, TX 78550

YOU ARE HEREBY AUTHORIZED TO PERFORM THE FOLLOWING ITEM(S) OF WORK AND TO ADJUST THE CONTINGENCY ALLOWANCE SUM ACCORDINGLY, AS INDICATED BELOW:

SCOPE OF WORK: CPR #50, CPR #64, and CPR #65
 DESCRIPTION OF WORK: electrical / data modifications, modify existing dumpster enclosure, and add security gate to catwalk ladder per owner's request
 JUSTIFICATION: specific owner requests
 ATTACHMENTS: Subcontractor's price quotes. Verifications of pricing from architect and B&A cost control. Also, submittal / cut sheets.

ORIGINAL CONTINGENCY AMOUNT	\$	300,000
CONTINGENCY EXPENDITURE PRIOR TO THIS AUTHORIZATION	\$	288,794
CONTINGENCY BALANCE PRIOR TO THIS AUTHORIZATION	\$	11,206
CONTINGENCY SUM WILL BE <i>(DECREASED)</i> BY THIS AUTHORIZATION	\$	9,447
REMAINING CONTINGENCY BALANCE	\$	1,759

ODR RECOMMENDATION: BROADDUS & ASSOCIATES
 By: Date: 10.25.10
 Grady J. Deaton, Ph.D.

ARCHITECT APPROVED: ERO
 By: Date: 11/2/10
 Eli Ochoa, P.E., AIA

CONTENT APPROVED: E.C.I.S.D
 By: _____ Date: _____
 Dr. Rene Gutierrez, Superintendent

CMR ACCEPTANCE: SpawGlass Contractors, Inc.
 By: Date: 11/1/10
 Steve Rodriguez, LEED AP

EXHIBIT _____

APPROVAL OF BID 11-16, AIR CONDITIONER FILTER MEDIA

Superintendent's Recommendation

That the Board of Trustees approve the recommendation to accept the Air Conditioner Filter Media bid as requested by the Maintenance & Facilities Department as being the most favorable and advantageous to the District.

Rationale

Air conditioner filters are needed for routine maintenance of air conditioner filter replacements. These are used district-wide. New bid includes media for new bond facilities.

The administration sought competitive sealed bids for the above mentioned bid. Bid opening was held at the Business Office Building on October 22, 2010, at 2:30 P.M. seven (7) proposals were received, opened, and read aloud.

User Department

This item was requested by Mr. Robert Saenz, Director of Maintenance & Facilities Department.

Budgetary Information

Award Recommendation: \$34,000.00

Account	Description	Appropriations	Encumbrance	Expenditure	Balance
199-51-6319-01-936-199-000	Supplies-Maint/Operations	232,163.00	17,074.53	19,547.34	195,541.13
	TOTALS	232,163.00	17,074.53	19,547.34	195,541.13

Resource Personnel

Dr. René Gutiérrez
Robert J. Saenz

Mario H. Salinas
Amaro Tijerina

Sylvia D. Garcia
Soledad Schuller

Board Policy Reference

This is in accordance with the Board Policy CH (Legal), Purchasing Law Bidding Requirements.

Prepared by: Robert J. Saenz for Robert Saenz
Robert J. Saenz, Director of Maintenance and Facilities

Approved by: Mario H. Salinas
Mario H. Salinas, Asst. Supt. District Administration

Within Budgetary Allocations: Sylvia D. Garcia
Sylvia D. Garcia, Director of Finance

Prepared by: Sylvia D. Garcia
Sylvia D. Garcia, Director of Finance

Recommended by: Dr. René Gutiérrez
Dr. René Gutiérrez, Superintendent of Schools

**Notes for Bid Tabulation
11-16, Air Conditioner Filter Media
November 30, 2010**

1. **USER DEPARTMENT:** This bid was requested by the Maintenance & Facilities Department. Mr. Robert Saenz will be present to answer any questions regarding this bid.
2. **TYPE OF BID:** This is a term bid beginning December 1, 2010 or soon thereafter and ending November 30, 2011.
3. **BID RENEWAL:** This bid contract has an option to renew for an additional 12 months if the vendor and the Edinburg Consolidated Independent School district agree in writing and there is no increase except for the districts growth.
4. **ORDERING INFORMATION:** Maintenance & Facilities Department will prepare purchase orders on an as needed basis after the Board of Trustee approval.
5. **APPROXIMATE AMOUNT SPENT LAST YEAR: \$34,000.00**
6. **AMENDED BID AWARD RECOMMENDATION:**

VENDOR	ESTIMATED AWARD RECOMMENDATION
Joe W. Fly 2810 N. Expwy. 77, Ste. C Harlingen, TX. 78550 Phone: 956-412-3234 Fax: 956-412-7447 Jessica Cortez	34,000.00
ESTIMATED TOTAL AWARD	\$34,000.00

***Awarded to lowest overall vendor.

EDINBURG CONSOLIDATED INDEPENDENT SCHOOL DISTRICT
EXTENDED AMOUNT ANALYSIS

VENDOR 1 (194)

VENDOR 2 (1429)

VENDOR 3 (190)

CONTROL: 10 A/C MEDIA		JOE W. FLY CO. INC.	AIR FLO FILTER	FILTER TECHNOLOGY COMPANY
PAGE/PART: 1/1		HARLINGEN TX 78550	MCALLEN TX 78501	ALTON TX 78573
BUYER: SOLEDAD SCHULLER	DELIVERY DAYS: 4	TERMS: NET 30	14	30
OPEN DATE: 10/22/10		OTHER 1: JESSICA CORTEZ	NET 30	NET 30
EFFECTIVE: 11/10/10		OTHER 2:	SEAN DONNELLY	DAVID WITTMAN
EXPIRATION: 10/31/11		NOTE:		
ENTERED: 10/25/10		CODES:		
PRINTED: 11/12/10				

031-45-23005-2	1" FILTER MEDIA, 16" X 20" X 1"	1 EACH	84.00 ✓	77.00	45.00
031-45-23015-1	1" FILTER MEDIA, 16" X 25" X 1"	1 EACH	890.00 ✓	830.00	490.00
031-45-23020-1	1" FILTER MEDIA, 20" X 20" X 1"	1 EACH	1780.00 ✓	1660.00	1060.00
031-45-23030-0	1" FILTER MEDIA, 20" X 25" X 1"	1 EACH	1940.00 ✓	1840.00	1200.00
031-45-23035-9	1" FILTER MEDIA, 24" X 24" X 1"	1 EACH	990.00 ✓	940.00	650.00
031-45-23040-9	1" FILTER MEDIA, 16" X 20" X 1"	1 EACH	237.00 ✓	195.00	1590.00
031-45-23045-8	1" FILTER MEDIA, 20" X 20" X 1"	1 EACH	445.00 ✓	345.00	260.00
031-45-23050-8	1" FILTER MEDIA, 20" X 25" X 1"	1 EACH	564.00 ✓	432.00	354.00
031-45-23055-7	1" FILTER MEDIA, 20" X 22" X 1"	1 EACH	285.00 ✓	210.00	360.00
031-45-25004-3	2" FILTER MEDIA, 16" X 20" X 2"	1 EACH	91.00 ✓	97.00	65.00
031-45-25014-2	2" FILTER MEDIA, 16" X 25" X 2"	1 EACH	109.00 ✓	106.00	67.00
031-45-25019-1	2" FILTER MEDIA, 20" X 20" X 2"	1 EACH	1090.00 ✓	1060.00	670.00
031-45-25024-1	2" FILTER MEDIA, 20" X 25" X 2"	1 EACH	1350.00 ✓	1310.00	960.00
031-45-25031-6	2" FILTER MEDIA, 24" X 24" X 2"	1 EACH	140.00 ✓	139.00	85.00
031-45-27000-9	4" FILTER MEDIA, 16" X 20" X 4", RFM, 10PF	1 EACH	72.50 ✓	87.50	119.50
031-45-27001-7	4" FILTER MEDIA, 16" X 25" X 4"	1 EACH	82.50 ✓	90.00	138.50
031-45-27010-8	4" FILTER MEDIA, 20" X 25" X 4", RFM, 10PF	1 EACH	99.50 ✓	100.00	158.50
031-45-27016-5	4" FILTER MEDIA, 24" X 24" X 4"	1 EACH	115.00 ✓	112.50	171.00
031-45-27019-9	4" FILTER MEDIA, 12" X 24" X 4"	1 EACH	64.50 ✓	65.50	118.50
031-45-27020-7	4" FILTER MEDIA, 12" X 24" X 4"	1 EACH	129.00 ✓	NB	216.00
031-45-27025-6	4" FILTER MEDIA, 24" X 24" X 4"	1 EACH	250.00 ✓	NB	1869.00
031-45-28010-7	16" X 20" X 2"	1 EACH	265.00 ✓	250.00	43.00

EXHIBIT _____

EDINBURG CONSOLIDATED INDEPENDENT SCHOOL DISTRICT EXTENDED AMOUNT ANALYSIS	VENDOR 1 (194)	VENDOR 2 (1429)	VENDOR 3 (190)
CONTROL: 10 A/C MEDIA	JOE W. FLY CO. INC.	AIR FLO FILTER	FILTER TECHNOLOGY COMPANY
PAGE/PART: 2/1	HARLINGEN TX 78550	MCALLEN TX 78501	ALTON TX 78573
BUYER: SOLEDAD SCHULLER	DELIVERY DAYS: 4	14	30
OPEN DATE: 10/22/10	TERMS: NET 30	NET 30	NET 30
EFFECTIVE: 11/10/10	OTHER 1: JESSICA CORTEZ	SEAN DONNELLY	DAVID WITTMAN
EXPIRATION: 10/31/11	OTHER 2:		
ENTERED: 10/25/10	NOTE:		
PRINTED: 11/12/10	CODES:		
031-45-28020-6 20" X 20" X 2"	1 EACH	305.00 ✓	291.00 50.00
031-45-28030-5 12" X 24" X 2"	1 EACH	265.00 ✓	250.00 43.00
031-45-28040-4 24" X 24" X 2"	1 EACH	359.00 ✓	370.00 61.00
031-45-28050-3 16" X 25" X 2"	1 EACH	305.00 ✓	285.00 49.00
031-45-28060-2 20" X 25" X 2"	1 EACH	329.00 ✓	332.00 54.00
031-45-28090-9 20" X 30" X 1"	1 EACH	379.00 ✓	767.00 129.00
031-45-28100-6 16" X 30" X 1"	1 EACH	379.00 ✓	489.00 119.00
031-45-28110-5 20" X 24" X 2"	1 EACH	329.00 ✓	340.00 54.00
031-45-30010-3 3 PLY, 15/40 LINK, DISPOSABLE PANEL AND LINK AIR FILTERS, 4 - 16 X 15 (16" X 60")	1 EACH	216.00 ✓	386.88 282.96
031-45-30020-2 3 PLY, 15/40 LINK, DISPOSABLE PANEL AND LINK AIR FILTERS, 4 - 16 X 17 (16" X 68")	1 EACH	1005.12 ✓	1682.88 1920.00
031-45-30030-1 3 PLY, 15/40 LINK, DISPOSABLE PANEL AND LINK AIR FILTERS, 5 - 16 X 20 (16" X 100")	1 EACH	159.48 ✓	253.20 235.80
031-45-30040-0 3 PLY, 15/40 LINK, DISPOSABLE PANEL AND LINK AIR FILTERS, 4 - 16 X 23 (16" X 92")	1 EACH	1674.00 ✓	2578.80 2164.80
031-45-30060-8 3 PLY, 15/40 LINK, DISPOSABLE PANEL AND LINK AIR FILTERS, 7 - 20 X 16 (20" X 112")	1 EACH	1224.00 ✓	2032.56 1980.72
031-45-30070-7 3 PLY, 15/40 LINK, DISPOSABLE PANEL AND LINK AIR FILTERS, 4 - 20 X 20 (20" X 80")	1 EACH	495.00 ✓	756.00 645.12
031-45-30090-5 3 PLY, 15/40 LINK, DISPOSABLE PANEL AND LINK AIR FILTERS, 3 - 20 X 25 (20" X 75")	1 EACH	122.50 ✓	187.60 152.50
031-45-30100-2 3 PLY, 15/40 LINK, DISPOSABLE PANEL AND LINK AIR FILTERS, 5 - 20 X 26 (20" X 130")	1 EACH	2820.96 ✓	3828.96 4671.36
031-45-30120-0 3 PLY, 15/40 LINK, DISPOSABLE PANEL AND LINK AIR FILTERS, 2 - 24 X 25 (24" X 50")	1 EACH	107.50 ✓	155.80 180.00
031-45-30130-9 3 PLY, 15/40 LINK, DISPOSABLE PANEL AND LINK AIR FILTERS, 4 - 25	1 EACH	137.50 ✓	210.00 223.60

EXHIBIT _____

EDINBURG CONSOLIDATED INDEPENDENT SCHOOL DISTRICT EXTENDED AMOUNT ANALYSIS	VENDOR 1 (194)	VENDOR 2 (1429)	VENDOR 3 (190)
CONTROL: 10 A/C MEDIA	JOE W. FLY CO. INC. HARLINGEN TX 78550	AIR FLO FILTER MCALLEN TX 78501	FILTER TECHNOLOGY COMPANY ALTON TX 78573
PAGE/PART: 3/1	DELIVERY DAYS: 4	14	30
BUYER: SOLEDAD SCHULLER	TERMS: NET 30	NET 30	NET 30
OPEN DATE: 10/22/10	OTHER 1: JESSICA CORTEZ	SEAN DONNELLY	DAVID WITTMAN
EFFECTIVE: 11/10/10	OTHER 2:		
EXPIRATION: 10/31/11	NOTE:		
ENTERED: 10/25/10	CODES:		
PRINTED: 11/12/10			
x 17(25" x 68")			
031-45-30140-8 3 PLY, 15/40 LINK, DISPOSABLE PANEL AND LINK AIR FILTERS, 3 - 25 x 18 (25" x 54")	1 EACH	117.50 ✓	190.00 187.50
031-45-30150-7 3 PLY, 15/40 LINK, DISPOSABLE PANEL AND LINK AIR FILTERS, 2 - 25 x 25 (25" x 50")	1 EACH	100.00 ✓	161.80 137.70
031-45-30160-6 3 PLY, 15/40 LINK, DISPOSABLE PANEL AND LINK AIR FILTERS, 2 - 25 x 31 (25" x 62")	1 EACH	141.00 ✓	225.12 220.32
031-45-30170-5 3 PLY, 15/40 LINK, DISPOSABLE PANEL AND LINK AIR FILTERS, 4 - 25 x 32 (25" x 72")	1 EACH	183.00 ✓	252.84 219.48
031-45-30200-0 3 PLY, 15/40 LINK, DISPOSABLE PANEL AND LINK AIR FILTER, 14" X 30" X 1"	1 EACH	60.00 ✓	161.80 55.40
031-45-30203-4 3 PLY, 15/40 LINK, DISPOSABLE PANEL AND LINK AIR FILTERS, 14" X 50" X 1"	1 EACH	192.00 ✓	508.56 252.96
031-45-30205-9 3 PLY, 15/40 LINK, DISPOSABLE PANEL AND LINK AIR FILTERS, 15" X 50" X 1"	1 EACH	192.00 ✓	420.00 277.44
031-45-30210-9 3 PLY, 15/40 LINK, DISPOSABLE PANEL AND LINK AIR FILTER, 16" X 40" X 1"	1 EACH	431.28 ✓	908.64 565.92
031-45-30220-8 3 PLY, 15/40 LINK, DISPOSABLE PANEL AND LINK AIR FILTERS, 16" X 44" X 1"	1 EACH	59.90 ✓	166.50 110.20
031-45-30230-7 3 PLY, 15/40 LINK, DISPOSABLE PANEL AND LINK AIR FILTERS, 16" X 48" X 1"	1 EACH	69.90 ✓	177.00 90.20
031-45-30240-6 3 PLY, 15/40 LINK, DISPOSABLE PANEL AND LINK AIR FILTERS, 16" X 125" X 1"	1 EACH	597.60 ✓	878.40 826.20
031-45-30250-5 3 PLY, 15/40 LINK, DISPOSABLE PANEL AND LINK AIR FILTERS, 20" X 24" X 1"	1 EACH	37.00 ✓	83.00 50.00
031-45-30260-4 3 PLY, 15/40 LINK, DISPOSABLE PANEL AND LINK AIR FILTERS, 20" X	1 EACH	143.64 ✓	298.60 189.00

EXHIBIT _____

EDINBURG CONSOLIDATED INDEPENDENT SCHOOL DISTRICT
EXTENDED AMOUNT ANALYSIS

VENDOR 1 (194)

VENDOR 2 (1429)

VENDOR 3 (190)

JOE W. FLY CO. INC.
HARLINGEN TX 78550

AIR FLO FILTER
MCALLEN TX 78501

FILTER TECHNOLOGY COMPANY
ALTON TX 78573

CONTROL: 10 A/C MEDIA
PAGE/PART: 4/1
BUYER: SOLEDAD SCHULLER
OPEN DATE: 10/22/10
EFFECTIVE: 11/10/10
EXPIRATION: 10/31/11
ENTERED: 10/25/10
PRINTED: 11/12/10

DELIVERY DAYS: 4
TERMS: NET 30
OTHER 1: JESSICA CORTEZ
OTHER 2:
NOTE:
CODES:

14
NET 30
SEAN DONNELLY

30
NET 30
DAVID WITTMAN

ITEM ID	DESCRIPTION	QUANTITY	UNIT PRICE	TOTAL PRICE	UNIT PRICE	TOTAL PRICE
031-45-30270-3	25" X 1" 3 PLY, 15/40 LINK, DISPOSABLE PANEL AND LINK AIR FILTERS, 20" X 40" X 1"	1 EACH	75.00 ✓	129.60	89.60	
031-45-30280-2	3 PLY, 15/40 LINK, DISPOSABLE PANEL AND LINK AIR FILTERS, 20" X 50" X 1"	1 EACH	98.40 ✓	165.96	126.00	
031-45-30290-1	3 PLY, 15/40 LINK, DISPOSABLE PANEL AND LINK AIR FILTERS, 20" X 72" X 1"	1 EACH	119.50 ✓	187.60	150.00	
031-45-30300-8	3 PLY, 15/40 LINK, DISPOSABLE PANEL AND LINK AIR FILTERS, 20" X 100" X 1"	1 EACH	1339.20 ✓	2177.28	1920.00	
031-45-30310-7	3 PLY, 15/40 LINK, DISPOSABLE PANEL AND LINK AIR FILTERS, 24" X 24" X 1"	1 EACH	105.60 ✓	206.40	136.32	
031-45-30320-6	3 PLY, 15/40 LINK, DISPOSABLE PANEL AND LINK AIR FILTERS, 24" X 36" X 1"	1 EACH	191.76 ✓	315.36	247.68	
031-45-30330-5	3 PLY, 15/40 LINK, DISPOSABLE PANEL AND LINK AIR FILTERS, 24" X 48" X 1"	1 EACH	87.50 ✓	145.80	135.30	
031-45-30335-4	3 PLY, 15/40 LINK, DISPOSABLE PANEL AND LINK AIR FILTERS, 25" X 48" X 1"	1 EACH	333.00 ✓	627.84	488.52	
031-45-30340-4	3 PLY, 15/40 LINK, DISPOSABLE PANEL AND LINK AIR FILTERS, 25" X 68" X 1"	1 EACH	270.00 ✓	502.56	536.64	
031-45-30350-3	3 PLY, 15/40 LINK, DISPOSABLE PANEL AND LINK AIR FILTERS, 25" X 52" X 1"	1 EACH	251.76 ✓	388.32	356.64	
031-45-30360-2	3 PLY, 15/40 LINK, DISPOSABLE PANEL AND LINK AIR FILTERS, 25" X 80" X 1"	1 EACH	156.50 ✓	226.80	200.00	
031-45-30370-1	3 PLY, 15/40 LINK, DISPOSABLE PANEL AND LINK AIR FILTERS, 20" X 48" X 1"	1 EACH	279.00 ✓	534.60	371.52	
031-45-35010-8	16" X 20"	1 EACH	60.00 ✓	181.44	142.32	
031-45-35020-7	20" X 20"	1 EACH	125.28 ✓	384.00	311.04	

EXHIBIT

EDINBURG CONSOLIDATED INDEPENDENT SCHOOL DISTRICT EXTENDED AMOUNT ANALYSIS	VENDOR 5 (3470)	VENDOR 6 (9763)	VENDOR 7 (196)
CONTROL: 10 A/C MEDIA	FILTERS FIRST DBA AIR FIL	AMERICAN A/C & HEATING	RIO FILTER SUPPLY COMPANY
PAGE/PART: 1/2	HARLINGEN TX 78550	HARLINGEN TX 78550	HARLINGEN TX 78550
BUYER: SOLEDAD SCHULLER	DELIVERY DAYS: 10	7	10
OPEN DATE: 10/22/10	TERMS: NET 30	-3% IF PAID IN 10 DAYS	-2% IF PAID IN 20 DAYS
EFFECTIVE: 11/10/10	OTHER 1: JUAN C RODRIGUEZ	OMAR J FLORES	CURTIS R CONRAD
EXPIRATION: 10/31/11	OTHER 2:		
ENTERED: 10/25/10	NOTE:		
PRINTED: 11/12/10	CODES:		
031-45-23005-2 1" FILTER MEDIA, 16" X 20" X 1"	1 EACH 90.00	957.00	60.00
031-45-23015-1 1" FILTER MEDIA, 16" X 25" X 1"	1 EACH 940.00	9570.00	680.00
031-45-23020-1 1" FILTER MEDIA, 20" X 20" X 1"	1 EACH 1880.00	19140.00	1240.00
031-45-23030-0 1" FILTER MEDIA, 20" X 25" X 1"	1 EACH 2200.00	19140.00	1500.00
031-45-23035-9 1" FILTER MEDIA, 24" X 24" X 1"	1 EACH 1100.00	9570.00	780.00
031-45-23040-9 1" FILTER MEDIA, 16" X 20" X 1"	1 EACH 270.00	2871.00	180.00
031-45-23045-8 1" FILTER MEDIA, 20" X 20" X 1"	1 EACH 470.00	4785.00	310.00
031-45-23050-8 1" FILTER MEDIA, 20" X 25" X 1"	1 EACH 660.00	5742.00	450.00
031-45-23055-7 1" FILTER MEDIA, 20" X 22" X 1"	1 EACH 330.00	2871.00	2010.00
031-45-25004-3 2" FILTER MEDIA, 16" X 20" X 2"	1 EACH 120.00	957.00	69.00
031-45-25014-2 2" FILTER MEDIA, 16" X 25" X 2"	1 EACH 125.00	957.00	78.00
031-45-25019-1 2" FILTER MEDIA, 20" X 20" X 2"	1 EACH 1250.00	9570.00	780.00
031-45-25024-1 2" FILTER MEDIA, 20" X 25" X 2"	1 EACH 1400.00	9570.00	860.00
031-45-25031-6 2" FILTER MEDIA, 24" X 24" X 2"	1 EACH 155.00	957.00	99.00
031-45-27000-9 4" FILTER MEDIA, 16" X 20" X 4", RFM, 10PF	1 EACH 100.00	478.50	193.50
031-45-27001-7 4" FILTER MEDIA, 16" X 25" X 4"	1 EACH 100.00	478.50	199.50
031-45-27010-8 4" FILTER MEDIA, 20" X 25" X 4", RFM, 10PF	1 EACH 105.00	478.50	202.50
031-45-27016-5 4" FILTER MEDIA, 24" X 24" X 4"	1 EACH 125.00	478.50	225.00
031-45-27019-9 4" FILTER MEDIA, 12" X 24" X 4"	1 EACH 72.50	478.50	184.00
031-45-27020-7 4" FILTER MEDIA, 12" X 24" X 4"	1 EACH 145.00	957.00	368.00
031-45-27025-6 4" FILTER MEDIA, 24" X 24" X 4"	1 EACH 145.00	957.00	450.00
031-45-28010-7 16" X 20" X 2"	1 EACH 240.00	957.00	367.00

EXHIBIT

EDINBURG CONSOLIDATED INDEPENDENT SCHOOL DISTRICT EXTENDED AMOUNT ANALYSIS	VENDOR 5 (3470)	VENDOR 6 (9763)	VENDOR 7 (196)	
CONTROL: 10 A/C MEDIA	FILTERS FIRST DBA AIR FIL HARLINGEN TX 78550	AMERICAN A/C & HEATING HARLINGEN TX 78550	RIO FILTER SUPPLY COMPANY HARLINGEN TX 78550	
PAGE/PART: 2/2	DELIVERY DAYS: 10	7	10	
BUYER: SOLEDAD SCHULLER	TERMS: NET 30	-3% IF PAID IN 10 DAYS	-2% IF PAID IN 20 DAYS	
OPEN DATE: 10/22/10	OTHER 1: JUAN C RODRIGUEZ	OMAR J FLORES	CURTIS R CONRAD	
EFFECTIVE: 11/10/10	OTHER 2:			
EXPIRATION: 10/31/11	NOTE:			
ENTERED: 10/25/10	CODES:			
PRINTED: 11/12/10				
031-45-28020-6 20" X 20" X 2"	1 EACH	280.00	957.00	419.00
031-45-28030-5 12" X 24" X 2"	1 EACH	250.00	957.00	384.00
031-45-28040-4 24" X 24" X 2"	1 EACH	260.00	957.00	543.00
031-45-28050-3 16" X 25" X 2"	1 EACH	270.00	957.00	417.00
031-45-28060-2 20" X 25" X 2"	1 EACH	340.00	957.00	470.00
031-45-28090-9 20" x 30" x 1"	1 EACH	750.00	957.00	523.00
031-45-28100-6 16" x 30" x 1"	1 EACH	490.00	957.00	523.00
031-45-28110-5 20" x 24" x 2"	1 EACH	360.00	957.00	518.00
031-45-30010-3 3 PLY, 15/40 LINK, DISPOSABLE PANEL AND LINK AIR FILTERS, 4 - 16 x 15 (16" x 60")	1 EACH	246.00	229.68	230.40
031-45-30020-2 3 PLY, 15/40 LINK, DISPOSABLE PANEL AND LINK AIR FILTERS, 4 - 16 x 17 (16" x 68")	1 EACH	1041.60	918.72	1044.48
031-45-30030-1 3 PLY, 15/40 LINK, DISPOSABLE PANEL AND LINK AIR FILTERS, 5 - 16 x 20 (16" x 100")	1 EACH	142.32	114.84	192.00
031-45-30040-0 3 PLY, 15/40 LINK, DISPOSABLE PANEL AND LINK AIR FILTERS, 4 - 16 x 23 (16" x 92")	1 EACH	1578.00	1148.40	1766.40
031-45-30060-8 3 PLY, 15/40 LINK, DISPOSABLE PANEL AND LINK AIR FILTERS, 7 - 20 x 16 (20" x 112")	1 EACH	1368.00	689.04	1612.80
031-45-30070-7 3 PLY, 15/40 LINK, DISPOSABLE PANEL AND LINK AIR FILTERS, 4 - 20 x 20 (20" x 80")	1 EACH	486.00	344.52	576.00
031-45-30090-5 3 PLY, 15/40 LINK, DISPOSABLE PANEL AND LINK AIR FILTERS, 3 - 20 x 25 (20" x 75")	1 EACH	130.00	95.70	150.00
031-45-30100-2 3 PLY, 15/40 LINK, DISPOSABLE PANEL AND LINK AIR FILTERS, 5 - 20 x 26 (20" x 130")	1 EACH	2952.00	1378.08	3744.00
031-45-30120-0 3 PLY, 15/40 LINK, DISPOSABLE PANEL AND LINK AIR FILTERS, 2 - 24 x 25 (24" x 50")	1 EACH	120.00	95.70	120.00
031-45-30130-9 3 PLY, 15/40 LINK, DISPOSABLE PANEL AND LINK AIR FILTERS, 4 - 25	1 EACH	139.00	95.70	170.00

EXHIBIT

EDINBURG CONSOLIDATED INDEPENDENT SCHOOL DISTRICT
EXTENDED AMOUNT ANALYSIS

VENDOR 5 (3470)

VENDOR 6 (9763)

VENDOR 7 (196)

CONTROL: 10 A/C MEDIA
PAGE/PART: 3/2
BUYER: SOLEDAD SCHULLER
OPEN DATE: 10/22/10
EFFECTIVE: 11/10/10
EXPIRATION: 10/31/11
ENTERED: 10/25/10
PRINTED: 11/12/10

DELIVERY DAYS:
TERMS:
OTHER 1:
OTHER 2:
NOTE:
CODES:

FILTERS FIRST DBA AIR FIL
HARLINGEN TX 78550
10
NET 30
JUAN C RODRIGUEZ
NOTE:
CODES:

AMERICAN A/C & HEATING
HARLINGEN TX 78550
7
-3% IF PAID IN 10 DAYS
OMAR J FLORES

RIO FILTER SUPPLY COMPANY
HARLINGEN TX 78550
10
-2% IF PAID IN 20 DAYS
CURTIS R CONRAD

x 17 (25" x 68")

ITEM ID	DESCRIPTION	QUANTITY	UNIT PRICE	TOTAL PRICE	AMOUNT
031-45-30140-8	3 PLY, 15/40 LINK, DISPOSABLE PANEL AND LINK AIR FILTERS, 3 - 25 x 18 (25" x 54")	1 EACH	129.00	95.70	135.00
031-45-30150-7	3 PLY, 15/40 LINK, DISPOSABLE PANEL AND LINK AIR FILTERS, 2 - 25 x 25 (25" x 50")	1 EACH	117.50	95.70	125.00
031-45-30160-6	3 PLY, 15/40 LINK, DISPOSABLE PANEL AND LINK AIR FILTERS, 2 - 25 x 31 (25" x 62')	1 EACH	150.00	114.84	186.00
031-45-30170-5	3 PLY, 15/40 LINK, DISPOSABLE PANEL AND LINK AIR FILTERS, 4 - 25 x 32 (25" x 72")	1 EACH	180.00	114.84	216.00
031-45-30200-0	3 PLY, 15/40 LINK, DISPOSABLE PANEL AND LINK AIR FILTER, 14" X 30" X 1"	1 EACH	117.50	95.70	72.00
031-45-30203-4	3 PLY, 15/40 LINK, DISPOSABLE PANEL AND LINK AIR FILTERS, 14" X 50" X 1"	1 EACH	300.00	229.68	288.00
031-45-30205-9	3 PLY, 15/40 LINK, DISPOSABLE PANEL AND LINK AIR FILTERS, 15" X 50" X 1"	1 EACH	336.00	229.68	324.00
031-45-30210-9	3 PLY, 15/40 LINK, DISPOSABLE PANEL AND LINK AIR FILTER, 16" X 40" X 1"	1 EACH	756.00	689.04	784.80
031-45-30220-8	3 PLY, 15/40 LINK, DISPOSABLE PANEL AND LINK AIR FILTERS, 16" X 44" X 1"	1 EACH	105.00	95.70	111.00
031-45-30230-7	3 PLY, 15/40 LINK, DISPOSABLE PANEL AND LINK AIR FILTERS, 16" X 48" X 1"	1 EACH	105.00	95.70	125.00
031-45-30240-6	3 PLY, 15/40 LINK, DISPOSABLE PANEL AND LINK AIR FILTERS, 16" X 125" X 1"	1 EACH	648.00	344.52	774.00
031-45-30250-5	3 PLY, 15/40 LINK, DISPOSABLE PANEL AND LINK AIR FILTERS, 20" X 24" X 1"	1 EACH	70.00	95.70	59.00
031-45-30260-4	3 PLY, 15/40 LINK, DISPOSABLE PANEL AND LINK AIR FILTERS, 20" X	1 EACH	252.00	344.52	219.60

EXHIBIT

EDINBURG CONSOLIDATED INDEPENDENT SCHOOL DISTRICT EXTENDED AMOUNT ANALYSIS	VENDOR 5 (3470)	VENDOR 6 (9763)	VENDOR 7 (196)
CONTROL: 10 A/C MEDIA	FILTERS FIRST DBA AIR FIL	AMERICAN A/C & HEATING	RIO FILTER SUPPLY COMPANY
PAGE/PART: 4/2	HARLINGEN TX 78550	HARLINGEN TX 78550	HARLINGEN TX 78550
BUYER: SOLEDAD SCHULLER	DELIVERY DAYS: 10	7	10
OPEN DATE: 10/22/10	TERMS: NET 30	-3% IF PAID IN 10 DAYS	-2% IF PAID IN 20 DAYS
EFFECTIVE: 11/10/10	OTHER 1: JUAN C RODRIGUEZ	OMAR J FLORES	CURTIS R CONRAD
EXPIRATION: 10/31/11	OTHER 2:		
ENTERED: 10/25/10	NOTE:		
PRINTED: 11/12/10	CODES:		
25" X 1"			
031-45-30270-3 3 PLY, 15/40 LINK, DISPOSABLE PANEL AND LINK AIR FILTERS, 20" X 40" X 1"	1 EACH 90.00	95.70	80.00
031-45-30280-2 3 PLY, 15/40 LINK, DISPOSABLE PANEL AND LINK AIR FILTERS, 20" X 50" X 1"	1 EACH 114.00	114.84	119.76
031-45-30290-1 3 PLY, 15/40 LINK, DISPOSABLE PANEL AND LINK AIR FILTERS, 20" X 72" X 1"	1 EACH 138.00	95.70	145.00
031-45-30300-8 3 PLY, 15/40 LINK, DISPOSABLE PANEL AND LINK AIR FILTERS, 20" X 100" X 1"	1 EACH 1420.80	918.72	2025.60
031-45-30310-7 3 PLY, 15/40 LINK, DISPOSABLE PANEL AND LINK AIR FILTERS, 24" X 24" X 1"	1 EACH 180.00	229.68	189.60
031-45-30320-6 3 PLY, 15/40 LINK, DISPOSABLE PANEL AND LINK AIR FILTERS, 24" X 36" X 1"	1 EACH 240.00	229.68	214.08
031-45-30330-5 3 PLY, 15/40 LINK, DISPOSABLE PANEL AND LINK AIR FILTERS, 24" X 48" X 1"	1 EACH 108.00	95.70	115.20
031-45-30335-4 3 PLY, 15/40 LINK, DISPOSABLE PANEL AND LINK AIR FILTERS, 25" X 48" X 1"	1 EACH 468.00	344.52	450.00
031-45-30340-4 3 PLY, 15/40 LINK, DISPOSABLE PANEL AND LINK AIR FILTERS, 25" X 68" X 1"	1 EACH 324.00	229.68	372.00
031-45-30350-3 3 PLY, 15/40 LINK, DISPOSABLE PANEL AND LINK AIR FILTERS, 25" X 52" X 1"	1 EACH 300.00	229.68	357.60
031-45-30360-2 3 PLY, 15/40 LINK, DISPOSABLE PANEL AND LINK AIR FILTERS, 25" X 80" X 1"	1 EACH 150.00	95.70	199.00
031-45-30370-1 3 PLY, 15/40 LINK, DISPOSABLE PANEL AND LINK AIR FILTERS, 20" X 48" X 1"	1 EACH 424.80	344.52	396.00
031-45-35010-8 16" X 20"	1 EACH 84.00	229.68	72.00
031-45-35020-7 20" X 20"	1 EACH 168.00	459.36	192.00

EXHIBIT

EDINBURG CONSOLIDATED INDEPENDENT SCHOOL DISTRICT	VENDOR 1 (194)	VENDOR 2 (1429)	VENDOR 3 (190)
EXTENDED AMOUNT ANALYSIS	-----		
	JOE W. FLY CO. INC.	AIR FLO FILTER	FILTER TECHNOLOGY COMPANY
CONTROL: 10 A/C MEDIA	HARLINGEN TX 78550	MCCALLEN TX 78501	ALTON TX 78573
PAGE/PART: 5/1	DELIVERY DAYS: 4	14	30
BUYER: SOLEDAD SCHULLER	TERMS: NET 30	NET 30	NET 30
OPEN DATE: 10/22/10	OTHER 1: JESSICA CORTEZ	SEAN DONNELLY	DAVID WITTMAN
EFFECTIVE: 11/10/10	OTHER 2:		
EXPIRATION: 10/31/11	NOTE:		
ENTERED: 10/25/10	CODES:		
PRINTED: 11/12/10			

031-45-35030-6 20" X 75"	1 EACH	212.16 ✓	900.48	1200.00
031-45-35040-5 20" X 80"	1 EACH	159.12 ✓	753.84	NB
031-45-35050-4 24" X 50"	1 EACH	41.76 ✓	186.96	281.76
031-45-35060-3 25" X 75"	1 EACH	47.88 ✓	242.40	291.48
031-45-40010-1 TRI-CELL 90, METAL FRAME NO HEADER, Box filter 20" X 24" X 12"	1 EACH	540.00 ✓	950.00	643.30
031-45-40020-0 TRI-CELL 90, METAL FRAME NO HEADER, Box filter 24" X 24" X 12"	1 EACH	580.00 ✓	1000.00	740.00
031-45-50005-8 FILTER MEDIA, DUAL PLY POLYESTER, 20" X 90' X 1", true MERV 8 as per ASHRAE 52.2 standards, 1	1 ROLL	249.95 ✓	290.00	406.30
031-45-50010-8 FILTER MEDIA, DUAL PLY POLYESTER, 20" X 90' X 2", true MERV 8 as per ASHRAE 52.2 STANDARDS, 1	1 ROLL	280.00 ✓	234.00	406.30
031-45-50015-7 FILTER MEDIA, DUAL PLY, POLYESTER, 25" X 90' X 1", true MERV 8 as per ASHRAE 52.2 standards, 1	1 ROLL	309.45 ✓	351.00	507.60
031-45-50020-7 FILTER MEDIA, DUAL PLY, POLYESTER, 25" X 90' X 2", tru MERV 8 as per ASHRAE 52.2 standards, 1	1 ROLL	349.95 ✓	292.50	507.60

CONTROL TOTAL	30272.65 LT ✓	-0-	-0-
---------------	---------------	-----	-----

ITEM COMMENTS

ITEM# VENDOR COMMENT

CODE DEFINITIONS

- * Low Bid On Item
- LT Low Total
- NB No Bid
- NI DidNot Bid All Items
- Q Different Quantity

EXHIBIT

EDINBURG CONSOLIDATED INDEPENDENT SCHOOL DISTRICT
EXTENDED AMOUNT ANALYSIS

VENDOR 5 (3470)

VENDOR 6 (9763)

VENDOR 7 (196)

CONTROL: 10 A/C MEDIA
PAGE/PART: 5/2
BUYER: SOLEDAD SCHULLER
OPEN DATE: 10/22/10
EFFECTIVE: 11/10/10
EXPIRATION: 10/31/11
ENTERED: 10/25/10
PRINTED: 11/12/10

DELIVERY DAYS:
TERMS:
OTHER 1:
OTHER 2:
NOTE:
CODES:

FILTERS FIRST DBA AIR FIL AMERICAN A/C & HEATING
HARLINGEN TX 78550
10
NET 30
JUAN C RODRIGUEZ
NOTE:
CODES:

RIO FILTER SUPPLY COMPANY
HARLINGEN TX 78550
10
-2% IF PAID IN 20 DAYS
CURTIS R CONRAD

Item Description	Quantity	Unit	Vendor 5 Price	Vendor 6 Price	Vendor 7 Price
031-45-35030-6 20" X 75"	1	EACH	672.00	459.36	720.00
031-45-35040-5 20" X 80"	1	EACH	576.00	344.52	576.00
031-45-35050-4 24" X 50"	1	EACH	144.00	114.84	204.00
031-45-35060-3 25" X 75"	1	EACH	180.00	114.84	216.00
031-45-40010-1 TRI-CELL 90, METAL FRAME NO HEADER, Box filter 20" X 24" X 12"	1	EACH	850.00	95.70	650.00
031-45-40020-0 TRI-CELL 90, METAL FRAME NO HEADER, Box filter 24" X 24" X 12"	1	EACH	950.00	95.70	700.00
031-45-50005-8 FILTER MEDIA, DUAL PLY POLYESTER, 20" X 90' X 1", true MERV 8 as per ASHRAE 52.2 standards, 1	1	ROLL	325.00	47.85	185.30
031-45-50010-8 FILTER MEDIA, DUAL PLY POLYESTER, 20" X 90' X 2", true MERV 8 as per ASHRAE 52.2 STANDARDS, 1	1	ROLL	250.00	47.85	303.75
031-45-50015-7 FILTER MEDIA, DUAL PLY, POLYESTER, 25" X 90' X 1", true MERV 8 as per ASHRAE 52.2 standards, 1	1	ROLL	375.00	47.85	231.60
031-45-50020-7 FILTER MEDIA, DUAL PLY, POLYESTER, 25" X 90' X 2", tru MERV 8 as per ASHRAE 52.2 standards, 1	1	ROLL	300.00	47.85	351.25

CONTROL TOTAL

0 0 0

EXHIBIT _____

11-16, AIR CONDITIONER FILTER MEDIA

180 74-1986477
AIR FILTER CO
301 NORTH MCCOLL
SPACE F
MCALLEN, TX 78501

181
AIR FILTER SALES/SERVICE
P.O. BOX 4142
CORPUS CHRISTI, TX 78496

1429 742609927
AIR FLO FILTER
820 E. WHITEWING
MCALLEN, TX 78501

3150 17601555182
B & B TECHNOLOGY INC
8282 WARREN ROAD
HOUSTON, TX 77040

558 15102876545
BAKER DISTRIBUTING
517 CEDAR AVENUE
BUILDING A
MCALLEN, TX 78501

183 463-56-5217
BEARD & ASSOCIATES
710 BUFFALO
SUITE 312B
CORPUS CHRISTI, TX 78401

4794 06-1519509
CARRIER SOUTH TEXAS
12625 WETMORE RD
SUITE 118
SAN ANTONIO, TX 78247-3609

9089
CAS COMPANIES
5402 S. EXPRESSWAY 83
HARLINGEN, TX 78552

5675 74-2673843
COLAIR, INC
P.O. BOX 1169
MISSION, TX 78573-0019

4255 1-7601840196
COMFORT SUPPLY INC
320 E. CEDAR
SUITE B
MCALLEN, TX 78501

3489 74-1601537
DAN'S REFRIGERATION SERVICE
P.O. BOX 795
PHARR, TX 78577

165 1-74-1972120-8
DEALERS ELECTRICAL SUPPLY
1401 EST UPAS
MCALLEN, TX 78501

5095 74-2319961
DIRTY DUCTS
817 S. ALAMO RD
ALAMO, TX 78516

2503 23-2069757
EDGEMONT PRECISION REBUILDERS
207 CARTER DR.
WEST CHESTER, PA 19382

1582 742530917
ELHARD AIR CONDITIONING & ELEC
1902 ANN STREET
EDINBURG, TX 78539

190 76-0253120
FILTER TECHNOLOGY COMPANY
304 ALVARADO ST
ALTON, TX 78573

3470 74-1986477
FILTERS FIRST DBA AIR FILTER
410 W. JACKSON
HARLINGEN, TX 78550

991 75-2516842
FMW DISTRIBUTORS INC
58 BROOKGREEN CIRCLE S.
MONTGOMERY, TX 77356

468 13611502801
GRAINGER
921 EAST PECAN BLVD
MCALLEN, TX 78501

4007 1-36-115-0280
GRAINGER
7950 RESEARCH BLVD
AUSTIN, TX 78758-8425

192 742488118
GULF COAST BEARING & SUPPLY
804 MOZELLE AVENUE
PHARR, TX 78577

193 1-74-2319961-5
HESS AIR INC
P O BOX 910
1/2 MI S ALAMO ROAD
ALAMO, TX 78516

11-16, AIR CONDITIONER FILTER MEDIA

1475 14104150108
HONEYWELL INC
506 SANDAU STE 250
SAN ANTONIO, TX 78216-3657

947 17413259460
INSCO DISTRIBUTING, INC
P O BOX 3188
1321 TAMARACK
MCALLEN, TX 78501

194 75-1374029-4
JOE W. FLY CO. INC.
2810 N EXPWY 77, SUITE C
HARLINGEN, TX 78550

4730
JOHNSON CONTROLS/YORK
117 AIRPORT ROAD
CORPUS CHRISTI, TX 78405

2763 1-74-2763168-8
JOHNSTONE SUPPLY
3107 N. SUGAR RD
PHARR, TX 78577

8574 42-0377110
LENNOX INDUSTRIES
9715 BENT OAK DRIVE
HOUSTON, TX 77040

157
MCCLELLAND ELECTRIC
2522 W FREDDY GONZALEZ
EDINBURG, TX 78539

476 74-19186931
OSMENTS APPLIANCE CENTER
P O BOX 5718
708 NOLANA LOOP
MCALLEN, TX 78502

7795 20-1818328
PERMANENT FILTER COMPANY LLC
2200 WEST ST. MARY BLVD.
LAFAYETTE, LA 70506

8376 41-2225913
PREMIER FILTRATION SERVICE
727 E. HWY. 83
WESLACO, TX 78596

196 465-62-0450
RIO FILTER SUPPLY COMPANY
210 N. EYE STREET
HARLINGEN, TX 78550

79 74-1709573
ROYAL CARPET & SERVICE
618 W. FERGUSON ST.
PHARR, TX 78577

966
TEMP CONTROL
295 U.S. HWY 281
BROWNSVILLE, TX 78520

557 74-1163372
TEXAIR COMPANY INC
2201 WEST EXPWY
MCALLEN, TX 78503

1196 741976051
TEXAS INDUSTRIES F/T BLIND & H
300 E. HIGHLAND MALL BLVD
SUITE 302
AUSTIN, TX 78752

582
TOTAL LINE CARRIER
3000 N. HIBISCUS
PHARR, TX 78577

1230 25-0900465
TRANE COMPANY
9535 BALL STREET, STE #1100
SAN ANTONIO, TX 78217

1000 74-2489949
VALLEY AIR PURIFICATION
1400 N. WARE ROAD
MCALLEN, TX 78501

4187 74-2641526
WARD SYSTEMS & SERVICES INC
2121 CEE GEE
SAN ANTONIO, TX 78217

Vendors Printed: 41

APPROVAL OF BID 11-26, REPLACEMENT OF AIR HANDLER UNITS AT EDINBURG NORTH HIGH SCHOOL

Superintendent's Recommendation

That the Board of Trustees approve the recommendation to accept the Replacement of Air Handler Units at Edinburg North High School Bid, which is indicated in the attached bid tabulation as being the most favorable and advantageous to the Edinburg CISD.

Rationale

Administration sought competitive sealed bids for Replacement of Air Handler Units at Edinburg North High School. Bid opening was held at the Business Office Building on November 5, 2010, at 2:30 P.M., where three (3) proposals were opened. Air Handler Units (AHU) #24, 25, 26 needs to be replaced to ensure adequate cooling is maintained and the learning environment is not affected. These units provide airflow to approximately 10 classrooms each in the 400 wing at Edinburg North High School. Performance can no longer be improved with routine maintenance. Existing units were originally manufactured by Trane Company.

User Department

This bid will be used by Maintenance and Facilities Department.

Budgetary Information

Award Recommendation **\$61,630.00**

Account	Description	Appropriations	Encumbrance	Expenditure	Balance
199-51-6397-00-936-199044	Fixed Assets-Inventory lte	379,537.00	12,927.70	1,400.00	365,209.30
TOTAL		379,537.00	12,927.70	1,400.00	365,209.30

Resource Personnel

Dr. René Gutiérrez	Sylvia D. Garcia	Mario H. Salinas
Robert J. Saenz	Amaro Tijerina	Jacqueline Kingan

Board Policy Reference

This is in accordance with Board Policy CH, Purchasing Law Bidding Requirements.

Prepared by: 
Robert J. Saenz, Director of Maintenance/Facilities

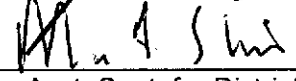
Approved by: 
Mario H. Salinas, Asst. Supt. for District Administration

Within Budgetary Allocations: 
Sylvia D. Garcia, Director for Finance

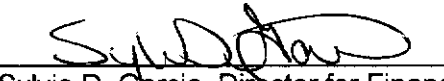
Approved by: 
Sylvia D. Garcia, Director for Finance

Recommended by: 
Dr. René Gutiérrez, Superintendent of Schools

Notes for Bid Tabulation
Bid 11-26, Replacement of Air Handler Units for Edinburg North High School
November 30, 2010

1. **USER DEPARTMENT:** This bid was requested by the Director of Maintenance and Facilities. Mr. Robert J. Saenz will be present to answer any detailed questions regarding this bid.
2. **TYPE OF BID:** This is a one time service.
3. **BID EVALUATION:** This bid was evaluated by a committee of Rene Olivarez, District Engineer; Jose L. Reyes, Air Conditioner Foreman; and Feliciano Ramirez, Chill Water Specialist. Final recommendations to the board are done by the Superintendent of School.
4. **ORDERING INFORMATION:** Maintenance Department will prepare the purchase order following Board of Trustee approval.
5. **TOTAL AWARD RECOMMENDATION:**

VENDORS	AWARD RECOMMENDATION
Trane 9535 Ball Street, Suite 1100 San Antonio, TX 78217 Contact: Stuart R. Werner PH: 800-647-0901 FAX: 210-516-1695	\$61,630.00
TOTAL AWARD RECOMMENDATION	\$61,630.00

**TABULATION OF
 BID 11-26, REPLACEMENT OF AIR HANDLER UNITS AT ENHS**

VENDORS	TOTAL OF MATERIALS	LABOR	TOTAL OF MATERIALS & LABOR	CAN YOU WORK AFTER 4:00 P.M. SAT, SUN & HOLIDAYS	LENGTH OF TIME TO ANSWER SERVICE CALLS	LENGTH OF TIME TO COMPLETE JOB
CAS COMPANIES, LP 111 Bland Lane Stafford, TX 77477 Contact: Raymond Moses PH: 956-216-8200 FAX: 956-216-8069	\$42,360.00	\$18,412.00	\$60,772.00	Yes	4 hours	4 weeks once equipment arrives
Pro Tech Mechanical, Inc. 5233 IH 37, Suite C-9 Corpus Christi, TX 78408 Contact: Tim Bradshaw PH: 800-882-2101 FAX: 361-882-2154:	\$38,196.00	\$28,254.00	\$66,450.00	Yes	2 hours	3 weeks
Trane 9535 Ball St., Ste 1100 San Antonio, TX 78217 Contact: Stuart R. Werner PH: 800-647-0901 FAX: 210-516-1695	\$37,594.00	\$24,036.00	\$61,630.00	Yes	4 hours	10 weeks

**POINTS FOR BID 11-26,
Replacement of Air Handler Units at ENHS**

POINTS	TRANE	PROTECH MECHANICAL	CAS COMPANIES
Proposed Price 30 points	24	18	27
Willingness to do work after hours 10 points	10	10	10
Length of time to answer service calls 10 points	10	10	8
Length of time to complete job 10 points	10	10	10
Past experience with school districts 15 points	15	13	7
TOTAL POINTS	69	61	62
	AWARD RECOMMENDATION		

EXHIBIT _____

11-26, REPLACEMENT OF AIR HANDLERS ENHS

558 15102876545
BAKER DISTRIBUTING
517 CEDAR AVENUE
BUILDING A
MCALLEN, TX 78501

7778 06-0991716
CARRIER COMMERCIAL SERVICE
1959 SARATOGA BLVD.
BUILDING #10
CORPUS CHRISTI, TX 78417

4794 06-1519509
CARRIER SOUTH TEXAS
12625 WETMORE RD
SUITE 118
SAN ANTONIO, TX 78247-3609

9089
CAS COMPANIES
5402 S. EXPRESSWAY 83
HARLINGEN, TX 78552

7504 76-0693469
CLEAN AIR SOLUTIONS
111 BRAND LANE
SUITE #400
STAFFORD, TX 77477

5675 74-2673843
COLAIR, INC
P.O. BOX 1169
MISSION, TX 78573-0019

4145 74-1604074
D & F INDUSTRIES INC
P.O. BOX 1680
PHARR, TX 78577

3489 74-1601537
DAN'S REFRIGERATION SERVICE
P.O. BOX 795
PHARR, TX 78577

165 1-74-1972120-8
DEALERS ELECTRICAL SUPPLY
1401 EST UPAS
MCALLEN, TX 78501

1582 742530917
ELHARD AIR CONDITIONING & ELEC
1902 ANN STREET
EDINBURG, TX 78539

991 75-2516842
FMW DISTRIBUTORS INC
58 BROOKGREEN CIRCLE S.
MONTGOMERY, TX 77356

9752
HERRERA & HUNT, INC.
1837 CISCO DRIVE
LOS FRESNOS, TX 78566

193 1-74-2319961-5
HESS AIR INC
P O BOX 910
1/2 MI S ALAMO ROAD
ALAMO, TX 78516

1475 14104150108
HONEYWELL INC
506 SANDAU STE 250
SAN ANTONIO, TX 78216-3657

947 17413259460
INSCO DISTRIBUTING, INC
P O BOX 3188
1321 TAMARACK
MCALLEN, TX 78501

4730
JOHNSON CONTROLS/YORK
117 AIRPORT ROAD
CORPUS CHRISTI, TX 78405

2763 1-74-2763168-8
JOHNSTONE SUPPLY
3107 N. SUGAR RD
PHARR, TX 78577

8574 42-0377110
LENNOX INDUSTRIES
9715 BENT OAK DRIVE
HOUSTON, TX 77040

5432 1-13-5526506-4
MSC INDUSTRIAL SUPPLY CO
2125 N. 77 SUNSHINE STRIP #3
HARLINGEN, TX 78550

8076
PROTECH MECHANICAL
5233 INTERSTATE HYW 37
SUITE C9
CORPUS CHRISTI, TX 78408

1304
SOLAR SUPPLY
1318 EAST LAUREL
MCALLEN, TX 78501

557 74-1163372
TEXAIR COMPANY INC
2201 WEST EXPWY
MCALLEN, TX 78503

11-26, REPLACEMENT OF AIR HANDLERS ENHS

1230 25-0900465
TRANE COMPANY
9535 BALL STREET, STE #1100
SAN ANTONIO, TX 78217

4187 74-2641526
WARD SYSTEMS & SERVICES INC
2121 CEE GEE
SAN ANTONIO, TX 78217

Vendors Printed: 24

APPROVAL OF BID 11-63, BUILDING AUTOMATION CONTROLS UPGRADE AT SOUTH MIDDLE SCHOOL FROM TEXAS MULTIPLE AWARD SCHEDULE

Superintendent's Recommendation

That the Board of Trustees approve the recommendation for Building Automation Controls Upgrade at South Middle School through the Texas Multiple Award Schedule (TXMAS) award contracts.

Rationale

The Texas Multiple Award Schedule sought competitive sealed bids and have awarded a contract to Johnson Controls for Maintenance and Repair Services for HVAC, Electrical, and Plumbing. This contract complies with all bidding requirements as required by federal, state, and local laws. Prices are based on Texas Multiple Award Schedule (TXMAS). Current Building Automation System (BAS) is not working. Network panel and devices are out of commission and not communicating to the front end. Existing control system is 15 years old and needs replacement. Chillers and air handlers are being turned on and off manually and overcooling. BAS will reduce energy consumption and control the comfort level and improve the learning environment. The target is to install system during December 2010 holidays.

User Department

This item was requested by Mr. Robert J. Saenz, Director of Maintenance and Facilities.

Budgetary Information

Award Recommendation **\$77,127.64**

Account	Description	Appropriations	Encumbrance	Expenditure	Balance
199-51-63XX-XX-936-1XXXXX	Supplies-Main/Operations	2,915,945.00	385,064.38	397,882.25	2,132,998.37
TOTAL		2,915,945.00	385,064.38	397,882.25	2,132,998.37

Resource Personnel

Dr. René Gutiérrez	Sylvia D. Garcia	Mario H. Salinas
Robert J. Saenz	Amaro Tijerina	Jacqueline Kingan

Board Policy Reference

This is in accordance with Board Policy CH, Purchasing Law Bidding Requirements.

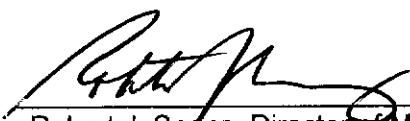
Prepared by: 
 Robert J. Saenz, Director of Maintenance/Facilities

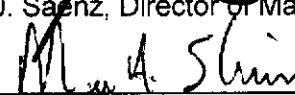
Approved by: 
 Mario H. Salinas, Asst. Supt. for District Administration

Within Budgetary Allocations: 
 Sylvia D. Garcia, Director for Finance

Approved by: 
 Sylvia D. Garcia, Director for Finance

Recommended by: 
 Dr. René Gutiérrez, Superintendent of Schools

EXHIBIT _____ PAGE(S) _____

Notes for Bid
Bid 11-63, Building Automation Controls Upgrade at South Middle School
Contract TXMAS – 5-03FAC020
November 30, 2010

1. **USER DEPARTMENT:** This bid was requested by the Director of Maintenance and Facilities. Mr. Robert J. Saenz will be present to answer any detailed questions regarding this bid.
2. **TYPE OF BID:** This is a TXMAS bid and a one time purchase.
3. **ORDERING INFORMATION:** Maintenance & Facilities Department will prepare the purchase orders following Board of Trustee approval.
4. **TOTAL AWARD RECOMMENDATION:**

VENDOR	ESTIMATED AWARD RECOMMENDATION
Rio Grande Valley Contract Johnson Controls, Inc. 117 Airport Road Corpus Christi, TX 78409 Contact: Adalberto Cavzos PH: 956-535-2718 FAX: 956-428-1591	\$77,127.64
TOTAL AWARD RECOMMENDATION	\$77,127.64

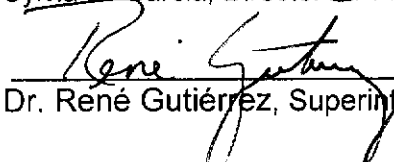

Susan Combs Texas Comptroller of Public Accounts

Search TXMAS Contracts: _____

Rebates: Pursuant to Texas Government Code § 2155.510(b), rebates generated from TXMAS contract purchases made using federal funds must be reported to the federal funding agency for reporting and reconciliation purchases. Each quarter of the State's fiscal year, TXMAS contractors rebate .75% of their TXMAS sales to the State of Texas via the Texas Comptroller of Public Accounts (CPA). It is the purchasing entity's responsibility to report the amount of rebate using the above percent based on the total dollar value of the TXMAS purchase order.

Example: A purchasing entity receives and uses federal funds of \$50,000 to purchase items/services on a TXMAS contract. The purchasing entity must report to the federal fund-provider that a sales rebate of \$375 ($\$50,000 * .75\% = \375) will be paid to the State of Texas by the TXMAS contractor.



JOHNSON CONTROLS, INC.
Contract TXMAS-5-03FAC020

On-Line Catalog/Order Processing

FACILITIES MAINTENANCE AND MANAGEMENT

Corporate Office:
 JOHNSON CONTROLS, INC.
 631 SOUTH RICHLAND AVE.
 YORK PA 17403-3348
 USA

Send PO to:

2101 E. ST. ELMO ROAD, STE. 330
 AUSTIN TX 78744
 USA
 Vendor ID: 11334734727

Invoice From:
 JOHNSON CONTROLS, INC.
 VARIES; SEE CONTRACTORS
 WEBSITE
 0
 USA
 Vendor ID:

Delivery: 30 DAYS ARO

FOB Point: JOBSITE

Terms: NET 30 DAYS

Remit To: JOHNSON CONTROLS,
 INC.
 P.O. BOX 951101
 DALLAS TX 75395-1101
 USA
 Vendor ID:

Vendor ID: 11334734727

Business Type: Large

DUNS #: 196561252

Effective: 12/8/2004

Expires: 7/13/2014

CONTACT: JOHN WENZEL
 Phone 240-683-7670
JOHN.S.WENZEL@JCI.COM

<http://portal.cpa.state.tx.us/txmas/txmasb.asp?CONTRACT=11758&dealer=0>

11/22/2010

EXHIBIT _____

Effective Date: This Texas Multiple Award Schedule (TXMAS) contract is effective beginning 12/8/2004 through 7/13/2014 and is automatically renewed on the date that the General Services Administration (GSA) exercises the renewal option. All State of Texas terms and conditions will continue and apply to all renewal periods by mutual agreement. The contractor has certified that the prices reflected in the contractor's catalog are the same as the prices contained in the most current modification to GSA Contract No. GS-06F-0060P.

Placement of Orders: Purchasing entities must use both the instructions on the contractor's web page and the terms and conditions in the federal supply schedule to place orders. Purchasing entities may use either a departmental purchase order or the contractor's on-line ordering system to place orders. Purchasing entities may opt out of using the contractor's on-line ordering system if it is incompatible with the entity's purchasing procedures. The contractor is not required to accept orders below the minimum listed below. Orders between the minimum and maximum listed below are subject to GSA preferred customer pricing. For orders above the maximum, purchasing entities are entitled to negotiate for lower prices than those listed on the on-line federal supply schedule price list.

Order Limitation:

Minimum Order: \$100

Maximum Order: \$1,500,000

Approved Products/Services: Only products or services listed in the CPA approved GSA contract may be purchased from this TXMAS contract, with one exception. Incidental, off-schedule items may be purchased as "best value, open market" items provided that they are necessary for product integration or product completeness. The purchasing entity is responsible for ensuring that the quoted price for such incidental items is fair and reasonable. These incidental items may be added to the TXMAS purchase order if they are clearly labeled as "open market (OM), best value" items.

State Contracts: All Texas Council for Purchasing from People with Disabilities contracts and Texas Correctional Industries (TCI) term contracts take precedence over this TXMAS contract. If similar products or services are listed on this TXMAS contract and a CPA term contract, a determination should be made that will result in a best value purchase.

Payment Due Date: Payment will be due on the thirtieth (30) calendar day after the later of: (a) the date the State actually receives a proper invoice at the office designated in the applicable purchase order to receive it; or (b) the date the State accepts the products or services. The post mark date on the envelope for the State warrant (State's equivalent to a check) or banking information showing when a direct deposit transaction was received will be considered the date payment is made. Interest starts accruing on the first day that payment is late. The rate of interest for late payments is set at one percent per month.

Special Note: The State of Texas, including but not limited to its Agencies, cooperative purchasing members and any local governmental entity authorized by law to use the Texas Multiple Award Schedule method for purchasing is not obligated to procure any products or services from this TXMAS contract. This schedule contract shall not be construed to prevent the State from purchasing products or services using other procurement methods as authorized by law.

Keywords: Complete Facilities Management Services, Complete Facilities Maintenance Services, maintenance and repair, elevator inspection and maintenance service,, plumbing and pipefitting, electrical including high/low voltage systems and utility service, Energy Management Control Services

<http://portal.cpa.state.tx.us/txmas/txmasb.asp?CONTRACT=11758&dealer=0>

11/22/2010

EXHIBIT _____

(EMCS), mechanical operations, maintenance and repair of building systems, heating ventilation Air Conditioning, HVAC, rental of maintenance equipment, refrigeration services, operation and maintenance of HVAC, operation and maintenance of water distribution system Refrigeration, HVAC Maintenance Services, periodic preventative maintenance(PPM), emergency service, retrofit aftermarket, Energy Management Control Services(EMCS), Direct Digital Control (DDC),Standard Communications Protocol-BACnet, cooling tower, chiller, pumps, boilers, air handlers, fan coils, variable air volume boxes, vav,refrigeration cycle, Sustainment Agreements, Performance based contracts , Total Service Agreements, parts and labor, Inspection-Plus Agreements Carrier, Trane,McQuay, Dunham-Bush, Inspection Agreements, Systems Evaluation, Master plans, Infrastructure, Centrifugal Compressor, Screw compressor, Reciprocating Compressor, Scroll compressor, remanufactured, Preventive Maintenance Predictive Analysis Vibration, oil refrigerant, fluid analysis, Air handler, Eddy Current Tube Testing, Dynamic Balancing, Air Curtains, Makeup Air Fans, Dust Collectors, Humidification, Air/Water Balancing, Fill / Louver Replacement, Alignments, Booster Systems, Exhaust Fans, Supply/Return Fans, Kitchen Ventilation, De-Humidification, Calibration, Ductwork

Contact Us

If you have any suggestions on how to improve TXMAS or this web site, please send an email to txmas@cpa.state.tx.us or call 512-463-3421.

[Texas Online](#) | [Statewide Search from the Texas State Library](#) | [State Link Policy](#) | [Texas Homeland Security](#)

Susan Combs, Texas Comptroller • [Window on State Government](#) • [Contact Us](#)
[Privacy and Security Policy](#) | [Accessibility Policy](#) | [Link Policy](#) | [Public Information Act](#) | [Compact with Texans](#)

<http://portal.cpa.state.tx.us/txmas/txmasb.asp?CONTRACT=11758&dealer=0>

11/22/2010

EXHIBIT _____



Proposal

Corpus Christi Service Branch
117 Airport Road
Corpus Christi, TX 78405
361-884-9675

TO: Edinburg ISD
1305 E. Schunior
Edinburg, TX 78539
Rene Olivarez

Date: November 22, 2010
Project: South Middle School BAS Retrofit
Proposal Ref: LC10272010A

We propose to furnish the materials and/or perform the work described below for the net price of:
\$77,127.64 Seventy-Seven Thousand, One Hundred Twenty-Seven AND 64/100 DOLLARS

For the above price this proposal includes:

We propose to furnish the services specified herein at the prices stated and in accordance with Johnson Controls standard terms and conditions. Johnson Controls would like to submit the following proposal for your review and approval. * Johnson Controls will provide the following labor and material to perform scope of the following work identified by the customer only. All work will be performed in accordance with the job specifications as provided by Johnson Controls.

Scope of Work:

* Provide & install Johnson Controls Web Based-Building Efficiency System to include point mapping with graphics for all new JCI installed controllers. Limited on-site training will be provided once the project is completed.

Johnson Controls Building Automation System will control & monitor the following:

- 2 Chillers Water Cooled with associated pumps (start/stop & status only)
- 1 Hot Water Boiler with associated pumps (start/stop & status only)
- 12 Multi-Zone Air Handlers
- 46 Zones
- Zone sensors will be replaced
- New return air temperature / humidity sensors will be installed on the AHU's
- New discharge air temperature sensors will be installed on the AHU's
- 6 Display modules on the FEC controllers will be installed to allow temporary control of AHU's that are not on the system

- All valves & valve actuators will be re-used (if components are defective this will be brought to Edinburg ISD Maintenance Department's attention)
- All dampers & damper actuators will be re-used (if components are defective this will be brought to Edinburg ISD Maintenance Department's attention)

Exclusions & Responsibilities:

- Controls are based on the original sequence of operations any additional points or modifications not original would require an additional proposal or change order
- Any type of upgrade on electrical or electrical repair is excluded
- Upgrade of controls outside of what is listed in the scope above is excluded
- Overtime is not included in this proposal
- Limited to the scope of work listed above, any additions items or work outside the scope would be quoted separately and or added as a change order to the contract at the customer's approval
- We currently exclude any additions to a change in the existing sequence of operation, if requested a cost value could be provided & if approved a change order to the initial contract would take place with approval.
- Any additional points than what is originally covered in the existing sequence of operation is excluded
- Limited to scope under division 15 specifications
- Customer is responsible to verify operation of fire alarm contactors in conjunction with smoke evacuation system & AHU shut down sequences.
- We will reuse existing control valves, & valve actuators, dampers & damper actuators if discovered while project is in progress that a component is defective the customer will be notified & a repair or replacement can be made by utilizing a change order or requesting a separate quote for this work to be performed.
- We will utilize existing control wire
- The customer is responsible to provide Ethernet drop & static IP address to Johnson Controls where necessary

This proposal and alternates listed below are hereby accepted and Johnson Controls is authorized to proceed with work; subject, however to credit approval by Johnson Controls, Inc., Milwaukee, Wisconsin.

This proposal is valid until: Nov. 27, 2010

Edinburg ISD

Johnson Controls, Inc.

Name: _____
Title: _____
Date: _____
PO: _____

Name: Lonnie Cavazos
Title: Account Executive
Date: 10-27-2010

EXHIBIT _____

TERMS AND CONDITIONS

By accepting this proposal, Purchaser agrees to be bound by the following terms and conditions:

1. **SCOPE OF WORK.** This proposal is based upon the use of straight time labor only. Plastering, patching and painting are excluded. "In-line" duct and piping devices, including, but not limited to, valves, dampers, humidifiers, wells, taps, flow meters, orifices, etc., if required hereunder to be furnished by Johnson Controls, Inc. (hereinafter referred to as JCI), shall be distributed and installed by others under JCI's supervision but at no additional cost to JCI. Purchaser agrees to provide JCI with required field utilities (electricity, toilets, drinking water, project hoist, elevator service, etc.) without charge. JCI agrees to keep the job site clean of debris arising out of its own operations. Purchaser shall not back charge JCI for any costs or expenses without JCI's written consent unless specifically noted in the statement of the scope of work or services undertaken by JCI under this agreement, JCI's obligations under this agreement expressly exclude any work or service of any nature associated or connected with the identification, abatement, clean up, control, removal, or disposal of environment Hazards or dangerous substances, to include but not be limited to asbestos or PCSs, discovered in or on the premises. Any language or provision of the agreement elsewhere contained which may authorize or empower the Purchaser to change, modify, or alter the scope of work or services to be performed by JCI shall not operate to compel JCI to perform any work relating to Hazards without JCI's express written consent.
2. **INVOICING & PAYMENTS.** JCI may invoice Purchaser monthly for all materials delivered to the job site or to an off-site storage facility and for all work performed on-site and off-site. Ten percent (10%) of the contract price is for engineering, drafting and other mobilization costs incurred prior to installation. This 10% shall be included in JCI's initial invoice. Purchaser agrees to pay JCI the amount invoiced upon receipt of the invoice. Waivers of lien will be furnished upon request as the work progresses to the extent payments are received. If JCI's invoice is not paid within 30 days of its issuance, it is delinquent.
3. **MATERIALS.** If the materials or equipment included in this proposal become temporarily or permanently unavailable for reasons beyond the control and without the fault of JCI, then in the case of such temporary unavailability, the time for performance of the work shall be extended to the extent thereof, and in the case of permanent unavailability, JCI shall (a) be excused from furnishing said materials or equipment, and (b) be reimbursed for the difference between the cost of the materials or equipment permanently unavailable and the cost of a reasonably available substitute therefore.
4. **WARRANTY.** JCI warrants that the equipment manufactured by it shall be free from defects in material and workmanship arising from normal usage for a period of one (1) year from delivery of said equipment, or if installed by JCI, for a period of one (1) year from installation. JCI warrants that for equipment furnished and/or installed but not manufactured by JCI, JCI will extend the same warranty terms and conditions which JCI receives from the manufacturer of said equipment. For equipment installed by JCI, if Purchaser provides written notice to JCI of any such defect within thirty (30) days after the appearance or discovery of such defect, JCI shall, at its option, repair or replace the defective equipment. For equipment not installed by JCI, if Purchaser returns the defective equipment to JCI within thirty (30) days after appearance or discovery of such defect, JCI shall, at its option, repair or replace the defective equipment and return said equipment to Purchaser. All transportation charges incurred in connection with the warranty for equipment not installed by JCI shall be borne by Purchaser. These warranties do not extend to any equipment which has been repaired by others, abused, altered or misused, or which has not been properly and reasonably maintained. THESE WARRANTIES ARE IN LIEU OF ALL OTHER WARRANTIES, EXPRESS OR IMPLIED, INCLUDING, BUT NOT LIMITED TO, THOSE OF MERCHANTABILITY AND FITNESS FOR A SPECIFIC PURPOSE
5. **LIABILITY.** JCI shall not be liable for any special, indirect or consequential damages arising in any manner from the equipment or material furnished or the work performed pursuant to this agreement.
6. **TAXES.** The price of this proposal does not include duties, sales, use, excise, or other similar taxes, unless required by federal, state or local law. In addition to the stated price, purchaser shall pay all taxes not legally required to be paid by JCI or, alternatively, shall provide JCI with acceptable tax exemption certificates. JCI shall provide Purchaser with any tax payment certificate upon request and after completion and acceptance of the work.
7. **DELAYS.** JCI shall not be liable for any delay in the performance of the work resulting from or attributed to acts or circumstances beyond JCI's control, including, but not limited to, acts of God, fire, riots, labor disputes, conditions of the premises, acts or omissions of the Purchaser, Owner or other Contractors or delays caused by suppliers or subcontractors of JCI, etc.
8. **COMPLIANCE WITH LAWS.** JCI shall comply with all applicable federal, state and local laws and regulations and shall obtain all temporary licenses and permits required for the prosecution of the work. Licenses and permits of a permanent nature shall be procured and paid for by the Purchaser.
9. **DISPUTES.** All disputes involving more than \$15,000 shall be resolved by arbitration in accordance with the rules of the American Arbitration Association. The prevailing party shall recover all legal costs and attorney's fees incurred as a result. Nothing here shall limit any rights under construction lien laws.
10. **INSURANCE.** Insurance coverage in excess of JCI's standard limits will be furnished when requested and required. No credit will be given or premium paid by JCI for insurance afforded by others.
11. **INDEMNITY.** The Parties hereto agree to indemnify each other from any and all liabilities, claims, expenses, losses or damages, including attorneys' fees, which may arise in connection with the execution of the work herein specified and which are caused, in whole or in part, by the negligent act or omission of the Indemnifying Party.

12. OCCUPATIONAL SAFETY AND HEALTH. The Parties hereto agree to notify each other immediately upon becoming aware of an inspection under, or any alleged violation of, the Occupational Safety and Health Act relating in any way to the project or project site.
13. ENTIRE AGREEMENT. This proposal, upon acceptance, shall constitute the entire agreement between the parties and supersedes any prior representations or understandings.
14. ENTIRE AGREEMENT. This proposal, upon acceptance, shall constitute the entire agreement between the parties and supersedes any prior representations or understandings.
15. CHANGES. No change or modification of any of the terms and conditions stated herein shall be binding upon Johnson unless accepted by Johnson in writing.

Field Equipment Controller (FEC) Series

Description

The FEC is a programmable digital controller that communicates via BACnet® Master-Slave/Token Passing (MS/TP) protocol. The FEC models include the 10-point FEC16 and the 17-point FEC26. FEC models include a 32-bit microprocessor, intuitive design, and are available with an optional built-in Liquid Crystal Display (LCD) screen local User Interface (UI).

A full range of FEC models combined with the Input/Output Module (IOM) models can be applied to a wide variety of building applications ranging from simple fan coil or heat pump control to advanced central plant management.

Refer to the *Metasys® System Field Equipment Controllers and Related Products Product Bulletin (LIT-12011042)* for important product application information.

Features

- Patented proportional adaptive control (P-Adaptive) and Pattern Recognition Adaptive Control (PRAC) technologies — provide continuous loop tuning
- User-friendly graphic theme and clear push-button identification — facilitate easy controller use
- Writable flash memory — allows you to download standard or customized applications from the Controller Configuration Tool (CCT) software

- Large product family — provides a wide range of point mix to meet application requirements and allows for the addition of one or more IOMs and/or Network Sensors to provide even more application capacity
- Network Automation Engine (NAE) and Network Control Engine (NCE) Automatic Discovery ability — allows for easy controller integration
- Local UI display option (integral display or stand-alone display) — provides enhanced local monitoring
- BACnet MS/TP communication — provides open system compatibility
- 32-bit microprocessor — ensures optimum performance and meets industry specifications
- Wireless capabilities via ZFR1800 Series Wireless Field Bus System enable wireless mesh connectivity between FECs to WRZ Series Wireless Room Temperature Sensors, and to NAE/NCE devices — facilitate easy initial location and relocation
- Universal and configurable inputs and outputs — support multiple signal options and increase controller application flexibility

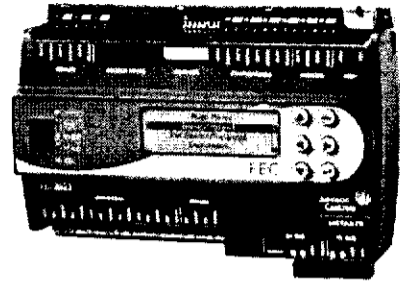

FEC26 Controller

Repair Information

If the Field Equipment Controller fails to operate within its specifications, replace the unit. For a replacement FEC, contact the nearest Johnson Controls® representative.

Selection Charts

FEC Series Point Type Counts per Model

Point Types	Signals Accepted	FEC16	FEC26
Universal Input (UI)	Analog Input, Voltage Mode, 0–10 VDC Analog Input, Current Mode, 4–20 mA ¹ Analog Input, Resistive Mode, 0–2k ohm, RTD (1k NI [Johnson Controls], 1k PT, A99B SI), NTC (10k Type L, 2.252k Type 2) Binary Input, Dry Contact Maintained Mode	2	6
Binary Input (BI)	Dry Contact Maintained Mode Pulse Counter/Accumulator Mode (High Speed), 100 Hz	1	2
Analog Output (AO)	Analog Output, Voltage Mode, 0–10 VDC Analog Output, Current Mode, 4–20 mA	0	2
Binary Output (BO)	24 VAC Triac	3	3
Configurable Output (CO)	Analog Output, Voltage Mode, 0–10 VDC Binary Output Mode, 24 VAC Triac	4	4

1. Analog Input, Current Mode is set by hardware for the FEC26, and as software for the FEC16.



Field Equipment Controller (FEC) Series (Continued)

Ordering Information

Product Code Number	Description
MS-FEC1611-0	10-Point Field Equipment Controller with 2 UI, 1 BI, 3 BO, and 4 CO; 24 VAC; SA Bus; Mounting Base
MS-FEC1621-0	10-Point Field Equipment Controller with 2 UI, 1 BI, 3 BO, and 4 CO; 24 VAC; SA Bus; Mounting Base; Integral Display
MS-FEC2611-0	17-Point Field Equipment Controller with 6 UI, 2 BI, 3 BO, 2 AO, and 4 CO; 24 VAC; SA Bus; Mounting Base
MS-FEC2621-0	17-Point Field Equipment Controller with 6 UI, 2 BI, 3 BO, 2 AO and 4 CO; 24 VAC; SA Bus; Integral Display; Mounting Base

Ordering Information for UL Listed, File S4977, UUKL 864 - 9th Edition, Smoke Control Equipment

Product Code Number ¹	Description
MS-FEU1610-0U	10-Point Field Equipment Controller with 2 UI, 1 BI, 3 BO, and 4 CO; 24 VAC; SA Bus; Mounting Base
MS-FEU1620-0U	10-Point Field Equipment Controller with 2 UI, 1 BI, 3 BO, and 4 CO; 24 VAC; SA Bus; Mounting Base; Integral Display
MS-FEU2610-0U	17-Point Field Equipment Controller with 6 UI, 2 BI, 3 BO, 2 AO, and 4 CO; 24 VAC; SA Bus; Mounting Base
MS-FEU2620-0U	17-Point Field Equipment Controller with 6 UI, 2 BI, 3 BO, 2 AO, and 4 CO; 24 VAC; SA Bus; Mounting Base; Integral Display

1. These devices are UL Listed, File S4977, UUKL 864 - 9th Edition, Smoke Control Equipment.

Accessories (Order Separately)

Product Code Number	Description
Y64T15-0	Transformer, 120/208/240 VAC Primary to 24 VAC Secondary, 92 VA, Foot Mount, 30 in. Primary Leads and 30 in. Secondary Leads, Class 2
Y65A13-0	Transformer, 120 VAC Primary to 24 VAC Secondary, 40 VA, Foot Mount (Y65AS), 8 in. Primary Leads and 30 in. Secondary Leads, Class 2
Y66T42-0	Transformer, 120/208/240 VAC Primary to 24 VAC Secondary, 40 VA, Hub Mount (Y65SP+), 8 in. Primary Leads and Secondary Screw Terminals, Class 2
Y66T31-0	Transformer, 120/208/240 VAC Primary to 24 VAC Secondary, 40 VA, Foot Mount (Y65AR+), 8 in. Primary Leads and Secondary Screw Terminals, Class 2
AP-TBK4SA-0	Replacement MS/TP SA Bus Terminal, 4-Position Connector, Brown, Bulk Pack
AP-TBK4FC-0	Replacement MS/TP FC Bus Terminal, 4-Position Connector, Blue, Bulk Pack
AP-TBK3PW-0	Replacement Power Terminal, 3-Position Connector, Gray, Bulk Pack
MS-BTCVT-1	Wireless Commissioning Converter, with Bluetooth® technology
MS-BTCVTCBL-700	Cable replacement Set for the MS-BTCVT-1 or the NS-ATV7003-0; includes one 5 ft (1.5 m) retractable cable.
MS-DIS1710-0	Local Controller Display for FEC1611 and FEC2611 models
MS-ZFR1810-0	Wireless Field Bus Coordinator, 10 mW Transmission Power. Functions with NAE35xx, NAE45xx, NAE55xx, and NCE25xx models.
MS-ZFR1811-0	Wireless Field Bus Router, 10 mW Transmission Power. Functions with Metasys BACnet FECs, VMA1600s, and WRZ-TTx Series Wireless Mesh Room Temperature Sensors.
MS-ZFRCBL-0	Wire Harness for use with ZFR1811 Router. Allows ZFR1811 Router to function with FEC1621; and with FEC1611, VMA1610, or VMA1620 controllers in conjunction with NS Series Sensors. Wireless Commissioning Converter, or DIS1710 Local Controller Display.

The performance specifications are nominal and conform to acceptable industry standards. For applications at conditions beyond these specifications, consult the local Johnson Controls office. Johnson Controls, Inc. shall not be liable for damages resulting from misapplication or misuse of its products. © 2010 Johnson Controls, Inc www.johnsoncontrols.com



Field Equipment Controller (FEC) Series (Continued)

Technical Specifications

FEC Series	
Product Code Numbers	MS-FEC1611-0 – Field Equipment Controller MS-FEC2611-0 – Field Equipment Controller MS-FEC1621-0 – Field Equipment Controller with Display and Push Button User Interface MS-FEC2621-0 – Field Equipment Controller with Display and Push Button User Interface
Supply Voltage	24 VAC (nominal, 20 VAC minimum/30 VAC maximum), 50/60 Hz, power supply Class 2 (North America), Safety Extra-Low Voltage (SELV) (Europe)
Power Consumption	14 VA maximum for FEC1611 and FEC2611 (no integral display) 20 VA maximum for FEC1621 and FEC2621 (with integral display) Note: VA ratings do not include any power supplied to the peripheral devices connected to Binary Outputs (BOs) or Configurable Outputs (COs), which can consume up to 12 VA for each BO or CO; for a possible total consumption of an additional 84 VA (maximum).
Ambient Conditions	Operating: 0 to 50°C (32 to 122°F); 10 to 90% RH noncondensing Storage: -40 to 80°C (-40 to 176°F); 5 to 95% RH noncondensing
Controller Addressing	DIP switch set; valid field controller device addresses 4–127 (Device addresses 0–3 and 128–255 are reserved and not valid field controller addresses.)
Communications Bus	BACnet® MS/TP, RS-485: 3-wire FC Bus between the supervisory controller and field controllers 4-wire SA Bus between field controller, network sensors, and other sensor/actuator devices, includes a lead to source 15 VDC supply power (from field controller) to bus devices. ¹
Processor	H8SX/166xR Renesas® microcontroller
Memory	1 MB Flash Memory and 512 KB Random Access Memory (RAM)
Input and Output Capabilities	FEC16 Models: 2 - Universal Inputs: Defined as 0–10 VDC, 4–20 mA, 0–600k ohm, or Binary Dry Contact 1 - Binary Inputs: Defined as Dry Contact Maintained or Pulse Counter/Accumulator Mode 3 - Binary Outputs: Defined as 24 VAC Triac (selectable internal or external source power) 4 - Configurable Outputs: Defined as 0–10 VDC or 24 VAC Triac BO FEC26 Models: 6 - Universal Inputs: Defined as 0–10 VDC, 4–20 mA, 0–600k ohm, or Binary Dry Contact 2 - Binary Inputs: Defined as Dry Contact Maintained or Pulse Counter/Accumulator Mode 3 - Binary Outputs: Defined as 24 VAC Triac (selectable internal or external source power) 4 - Configurable Outputs: Defined as 0–10 VDC or 24 VAC Triac BO 2 - Analog Outputs: Defined as 0–10 VDC or 4–20 mA
Analog Input/Analog Output Resolution and Accuracy	Analog Input: 16-bit resolution Analog Output: 16-bit resolution and ±200 mV in 0–10 VDC applications
Terminations	Input/Output: Fixed Screw Terminal Blocks FC Bus, SA Bus, and Supply Power: 3-Wire and 4-Wire Pluggable Screw Terminal Blocks FC Bus and SA Bus: RJ-12 6-Pin Modular Jacks
Mounting	Horizontal on single 35 mm DIN rail mount (preferred), or screw mount on flat surface with three integral mounting clips on controller
Housing	Enclosure material: ABS and polycarbonate UL94 5VB; Self-extinguishing, Plenum-rated Protection Class: IP20 (IEC529)
Dimensions (Height x Width x Depth)	FEC16 Models: 150 x 164 x 53 mm (5-7/8 x 6-7/16 x 2-1/8 in.) including terminals and mounting clips FEC26 Models: 150 x 190 x 53 mm (5-7/8 x 7-1/2 x 2-1/8 in.) including terminals and mounting clips Note: Mounting space for FEC16 and FEC26 Models requires an additional 50 mm (2 in.) space on top, bottom, and front face of controller for easy cover removal, ventilation, and wire terminations.
Weight	FEC16 Models: 0.4 kg (0.9 lb) FEC26 Models: 0.5 kg (1.1 lb)
Compliance	United States: UL Listed, File E107041, CCN PAZX, UL 916, Energy Management Equipment; FCC Compliant to CFR47, Part 15, Subpart B, Class A Canada: UL Listed, File E107041, CCN PAZX7, CAN/CSA C22.2 No. 205, Signal Equipment Industry Canada Compliant, ICES-003 Europe: CE Mark, EMC Directive 2004/108/EC, in accordance with EN 61000-6-3 (2007) Generic Emission Standard for Residential and Light Industry and EN 61000-6-2 (2005) Generic Immunity Standard for Heavy Industrial Environment Note: For FEC26 Models, Conducted RF Immunity within EN 61000-6-2 meets performance criteria B. Australia and New Zealand: C-Tick Mark, Australia/NZ Emissions Compliant BACnet International: BACnet Testing Laboratories™ (BTL) 135-2004 Listed BACnet Application Specific Controller (B-ASC)

1. For more information, refer to the *MS/TP Communications Bus Technical Bulletin (LIT-12011034)*.

The performance specifications are nominal and conform to acceptable industry standards. For applications at conditions beyond these specifications, consult the local Johnson Controls office. Johnson Controls, Inc. shall not be liable for damages resulting from misapplication or misuse of its products. © 2010 Johnson Controls, Inc. www.johnsoncontrols.com

TE-6700

2nd Generation Temperature Elements

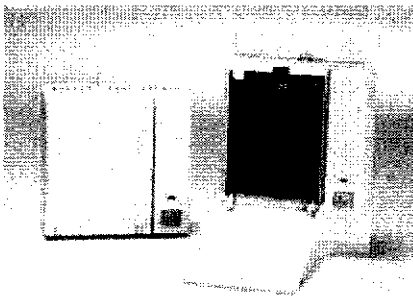

TE-6700 Series Temperature Elements

Description

The TE-6700 Series is our 2nd Generation of temperature elements. These attractively styled, feature-packed temperature sensing products offer ease of installation, user friendliness, and application flexibility in one package.

The TE-6700 Series Temperature Elements supersede the TE-6400 Series for space sensing applications. The 2nd Generation elements are designed for use with most Johnson Controls controllers, and now work directly with the VMA1200 and VMA1400 Series controllers.

Features

- temperature sensor Time Response Improvement (TRI) provides better temperature local control, increases employee comfort, and reduces energy consumption
- controller configuration switch allows users to choose occupancy features that match the application and controller
- occupancy light-emitting diode (LED) indicator displays the controller's current operating mode
- manual override pushbutton (PB) signals the controller that the space is occupied; this overrides time-of-day scheduling
- globally scaled units include setpoint and bulb indicator (both optional) that measure Fahrenheit and Celsius ranges, 65 to 85°F (19 to 29°C)
- universal mounting — ships with wallbox and surface mounting plate (all installation hardware included)
- single or dual setpoint adjustment allows for separate heating and cooling settings; this makes setpoint viewing and adjustment easier
- Analog Profile and Starfield Display compatible — analyzes heating and cooling efficiency with the M-Series Workstation

Accessories

Code Number	Description
ACC-DWCLIP-0	Drywall Clip Mounting Kit (10 per bag)
ACC-INSL-0 ^(a)	Foam Pad Kit for Wallbox Mounting (10 per package)
ACC-INSL-1 ^(a)	Foam Pad Kit for Surface Mounting (10 per package)
GRD10A-608	Plastic Guard with Baseplate and Mounting Ring
T-4000-119	Allen-Head Adjustment Tool (30 per bag)
TE-67L-600	Fahrenheit Label Replacement Kit
TE-67L-601	Celsius Label Replacement Kit
TE-67MB-600	Mounting Base Kit
TE-67D0-601 ^(b)	Door Replacement Kit with a Johnson Controls Logo (10 per box)
TE-67D0-602 ^(b)	Door Replacement Kit without a Logo (10 per box)

(a) These foam pads will prevent drafts from entering the unit through the wall, and make installation easier when mounting on an uneven surface.

(b) Contains 10 original style and 10 new style doors

Repair Parts

The TE-6700 transmitters are not field repairable.

IMPORTANT: The Printed Circuit Board (PCB) is retained with a tamper-resistant mechanism. Removal of the PCB from the plastic housing will void the product warranty.

Selection Chart

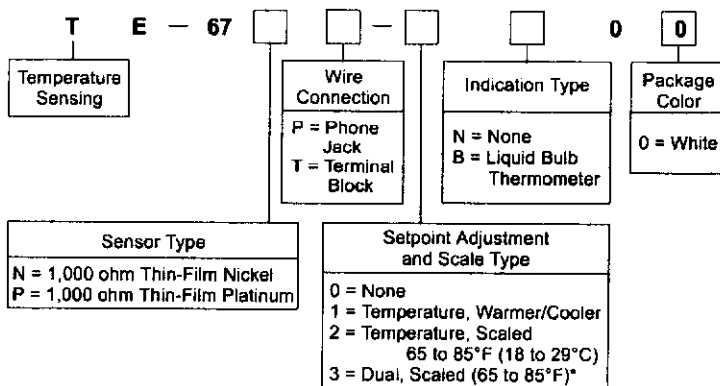

* These models do not have a functioning LED, but all models have the manual override PB.

Example 1: To order a nickel sensor with a phone jack, a warmer/cooler temperature setpoint, and a liquid bulb thermometer, specify Product Code Number TE-67NP-1B00.

Example 2: To order a platinum sensor with a terminal block, a scaled temperature setpoint, and no indication, specify Product Code Number TE-67PT-2N00.

The performance specifications are nominal and conform to acceptable industry standards. For applications at conditions beyond these specifications, consult the local Johnson Controls office. Johnson Controls, Inc. shall not be liable for damages resulting from misapplication or misuse of its products. © 12/02 Johnson Controls, Inc.

TE-6700 2nd Generation Temperature Elements (Continued)

Specifications

TE-6700 2nd Generation Temperature Elements	
Nickel Sensor	Temperature Sensor: 1,000 ohm thin-film nickel
	Temperature Coefficient: Approximately 3 ohms per F° (5.4 ohms per C°)
	Reference Resistance: 1,000 ohms at 70°F (21°C)
	Accuracy: ±0.34F° at 70°F (±0.18C° at 21°C)
Platinum Sensor	Temperature Sensor: 1,000 ohm thin-film platinum
	Temperature Coefficient: Approximately 2 ohms per F° (5.4 ohms per C°)
	Reference Resistance: 1,000 ohms at 32°F (0°C)
	Accuracy: ±0.65F° at 70°F (±0.36C° at 21°C)
Temperature Indicator	Type: Liquid filled bulb thermometer
	Range: 40 to 90°F or 5 to 30°C
	Resolution: Fahrenheit scale graduated at 10F° intervals; Celsius scale and graduated at 5C° intervals.
Setpoint	Single Adjustment: Warmer/cooler, red/blue visual scale, or temperature – scaled °F/°C
	Dual Adjustment: Heating and cooling, graduated scale 65 to 85°F (Fahrenheit only; no Celsius scale)
	Resistance: Nominal 1.5k ohm
	Resolution: Fahrenheit scale graduated at 5F° intervals; Celsius scale at 2C° intervals
Sensor Response Time	One time constant = 8 minutes ±2 minutes at 10 feet per minute (fpm) airflow rate
Field Connections	Phone Jack: 8-pin connector for 8-conductor 24 AWG phone cable Terminal Block: Screw type terminals for 18 to 24 AWG wire
Zone Bus Access	6-pin connector with front access for a laptop with HVAC PRO™ software, PalmPilot™ with VMA Balancing Tool (VBT) software, or a Zone Terminal (ZT).
Manual Override	Integral momentary pushbutton (DIP switch selectable)
LED Display	Red LED indicates three modes of operation (application and controller type dependent).
Ambient Operating Conditions	32 to 131°F (0 to 55°C) 0 to 100% RH, noncondensing; 85°F (29°C) maximum dew point
Ambient Storage Conditions	-40 to 160°F (-40 to 71°C) 0 to 100% RH, noncondensing; 85°F (29°C) maximum dew point
Mounting Style	Standard base for both surface and U.S. wallbox mounting, including hardware
Materials	White PC/ABS plastic case and mounting base
Dimensions (H x W x D)	3.2 x 3.2 x 1.4 in. (81 x 81 x 36 mm)
Shipping Weight	1 lb (0.5 kg)

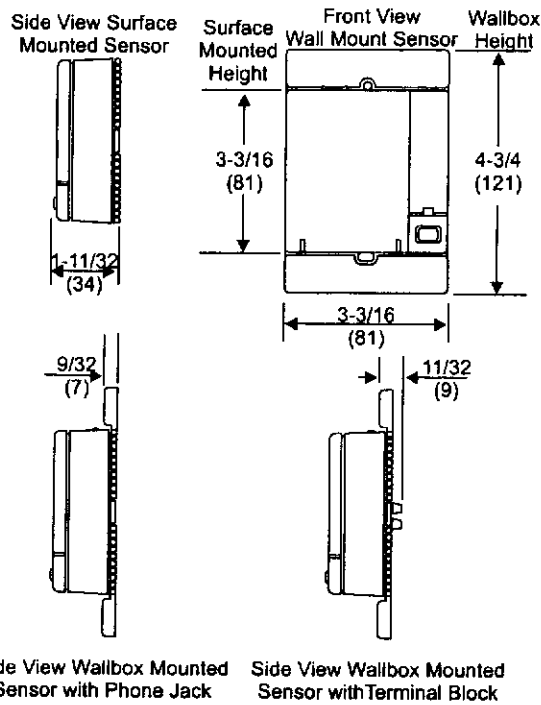

The performance specifications are nominal and conform to acceptable industry standards. For applications at conditions beyond these specifications, consult the local Johnson Controls office. Johnson Controls, Inc. shall not be liable for damages resulting from misapplication or misuse of its products. © 12/02 Johnson Controls, Inc

MS-NAE35xx-x, MS-NAE45xx-x, MS-NAE55xx-x, NAE8500-0

Network Automation Engine

Description

Network Automation Engines (NAEs) enable Internet Protocol (IP) connectivity and Web-based access to Metasys® Building Management Systems (BMSs).

NAEs leverage standard building management communication technologies, including BACnet® protocol, LONWORKS® network, and N2 Bus protocol to monitor and supervise a wide variety of Heating, Ventilating, and Air Conditioning (HVAC); lighting; security; fire; and access control equipment.

NAEs provide comprehensive equipment monitoring and control, scheduling, alarm and event management, energy management, data exchange, data trending, and data storage.

NAEs feature an embedded Site Management Portal user interface, support multiple concurrent Web browser sessions with password and permission access control, and provide the protection of industry standard Information Technology (IT) security.

NAE55 models support a comprehensive set of supervisory features and functions for large facilities and technically advanced buildings and complexes.

The NAE35/NAE45 models enable cost-effective NAE connectivity and control in smaller facilities, and can extend NAE supervisory functions in larger facilities.

The NAE85 is a high-capacity NAE that allows integration of large BACnet IP systems and can take the place of multiple NAEs.

Refer to the *Network Automation Engine Product Bulletin (LIT-1201160)* for important product application information.

Features

- communication using commonly accepted IT standards at the automation and enterprise level
- Web-based user interface
- Site Director function
- support for Web services at the automation network level
- user interface and online system configuration software embedded in NAE
- supervision of field controller networks including N2 Bus, LONWORKS network, BACnet Master-Slave/Token-Passing (MS/TP), and BACnet IP devices
- multiple connection options for data access

Repair Information

If the NAE fails to operate within its specifications, refer to the *Network Automation Engine (NAE) Product Bulletin (LIT-1201160)* for a list of repair parts available.

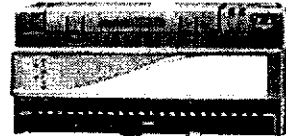

NAE35/NAE45

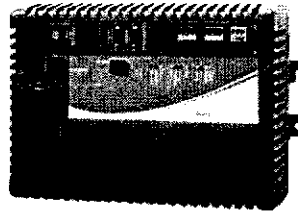

NAE55



NAE85

Selection Charts

NAE35

Product Code Number ¹	Description
MS-NAE35xx-x (Base Features of Each NAE35)	NAE35 Network Automation Engines: Requires a 24 VAC power supply. Each model includes one RS-232-C serial port, one USB serial port, one Ethernet port, and an MS-BAT1020-0 Data Protection Battery.
MS-NAE3510-2	Supports one N2 or BACnet MS/TP (RS-485) trunk; includes an additional RS-232-C serial port for optional external modem; supports up to 50 devices on the N2 or BACnet MS/TP trunk.
MS-NAE3510-2U	Supports one N2 or BACnet MS/TP (RS-485) trunk; includes an additional RS-232-C serial port for optional external modem; supports up to 50 devices on the N2 or BACnet MS/TP trunk. Note: This model is UL Listed, File S4977, UUKL 864 - 9th Edition, Smoke Control Equipment.
MS-NAE3511-2	Supports one N2 or BACnet MS/TP (RS-485) trunk; includes an internal modem; supports up to 50 devices on the N2 or BACnet MS/TP trunk.
MS-NAE3514-2	Supports one N2 or BACnet MS/TP (RS-485) trunk; features Basic Access support; includes an additional RS-232-C serial port for optional external modem; supports up to 50 devices on the N2 or BACnet MS/TP trunk.
MS-NAE3515-2	Supports one N2 or BACnet MS/TP (RS-485) trunk; features Basic Access support; includes an internal modem; supports up to 50 devices on the N2 or BACnet MS/TP trunk.
MS-NAE3520-2	Supports one LONWORKS trunk, includes an additional RS-232-C serial port for optional external modem. Supports up to 64 devices on the LONWORKS port.
MS-NAE3520-2U	Supports one LONWORKS trunk, includes an additional RS-232-C serial port for optional external modem. Supports up to 64 devices on the LONWORKS port. Note: This model is UL Listed, File S4977, UUKL 864 - 9th Edition, Smoke Control Equipment.
MS-NAE3521-2	Supports one LONWORKS trunk, includes an internal modem. Supports up to 64 devices on the LONWORKS port.
MS-NAE3524-2	Supports one LONWORKS trunk, features Basic Access support, and includes an additional RS-232-C serial port for optional external modem. Supports up to 64 devices on the LONWORKS trunks.
MS-NAE3525-2	Supports one LONWORKS trunk, features Basic Access support, and includes an internal modem. Supports up to 64 devices on the LONWORKS trunks.

1. Some models are also available in a Buy American version (add a G after the code number). For repair parts, add -702 after the code number.

The performance specifications are nominal and conform to acceptable industry standards. For applications at conditions beyond these specifications, consult the local Johnson Controls office. Johnson Controls, Inc. shall not be liable for damages resulting from misapplication or misuse of its products. © 2010 Johnson Controls, Inc. www.johnsoncontrols.com



Network Automation Engine (Continued)

NAE45

Product Code Number ¹	Description
MS-NAE45xx-x (Base features of each NAE45)	NAE45 Network Automation Engines: Requires a 24 VAC power supply. Each model includes one RS-232-C serial port, one USB serial port, one Ethernet port, and an MS-BAT1020-0 Data Protection Battery.
MS-NAE4510-2	Supports one N2 or BACnet MS/TP (RS-485) trunk; includes an additional RS-232-C serial port for optional external modem; supports up to 100 devices on the N2 or BACnet MS/TP trunk.
MS-NAE4510-2U	Supports one N2 or BACnet MS/TP (RS-485) trunk; includes an additional RS-232-C serial port for optional external modem; supports up to 100 devices on the N2 or BACnet MS/TP trunk. Note: This model is UL Listed, File S4977, UUKL 864 - 9th Edition, Smoke Control Equipment.
MS-NAE4511-2	Supports one N2 or BACnet MS/TP (RS-485) trunk; includes an internal modem; supports up to 100 devices on the N2 or BACnet MS/TP trunk.
MS-NAE4520-2	Supports one LONWORKS trunk, includes an additional RS-232-C serial port for optional external modem; supports up to 127 devices on the LONWORKS port.
MS-NAE4520-2U	Supports one LONWORKS trunk, includes an additional RS-232-C serial port for optional external modem; supports up to 127 devices on the LONWORKS port. Note: This model is UL Listed, File S4977, UUKL 864 - 9th Edition, Smoke Control Equipment.
MS-NAE4521-2	Supports one LONWORKS trunk, includes an internal modem; supports up to 127 devices on the LONWORKS port.

1. Some models are also available in a Buy American version (add a G after the code number). For repair parts, add -702 after the code number.

NAE55

Product Code Number ¹	Description
MS-NAE55xx-x (Base features of each NAE55)	NAE55 Network Automation Engines: Requires a 24 VAC power supply. Each model includes two RS-232-C serial ports, two USB serial ports, two RS-485 ports, one Ethernet port, and one MS-BAT1010-0 Data Protection Battery. Supports up to 100 devices on each N2 or BACnet MS/TP trunk.
MS-NAE5510-1	Supports two N2 or two BACnet MS/TP (RS-485) trunks (or one N2 trunk and one BACnet MS/TP trunk).
MS-NAE5510-1U	Supports two N2 or two BACnet MS/TP trunks (or one N2 trunk and one BACnet MS/TP trunk). Note: This model is UL Listed, File S4977, UUKL 864 - 9th Edition, Smoke Control Equipment.
MS-NAE5511-1	Supports two N2 or two BACnet MS/TP (RS-485) trunks (or one N2 trunk and one BACnet MS/TP trunk); includes an internal modem.
MS-NAE5512-1	Supports two N2 or two BACnet MS/TP (RS-485) trunks (or one N2 trunk and one BACnet MS/TP trunk). Note: MS-NAE5512-1 models support N2 tunneling on N2 trunks (only).
MS-NAE5513-1	Supports two N2 or two BACnet MS/TP (RS-485) trunks (or one N2 trunk and one BACnet MS/TP trunk); includes an internal modem. Note: MS-NAE5513-1 models support N2 tunneling on N2 trunks (only).
MS-NAE5520-1	Supports a LONWORKS trunk, and two N2 trunks or two BACnet MS/TP (RS-485) trunks (or one N2 trunk and one BACnet MS/TP trunk). Supports up to 255 devices on the LONWORKS trunk.
MS-NAE5520-1U	Supports a LONWORKS trunk, and two N2 trunks or two BACnet MS/TP (RS-485) trunks (or one N2 trunk and one BACnet MS/TP trunk). Supports up to 255 devices on the LONWORKS trunk. Note: This model is UL Listed, File S4977, UUKL 864 - 9th Edition, Smoke Control Equipment.
MS-NAE5521-1	Supports a LONWORKS trunk, and two N2 trunks or two BACnet MS/TP (RS-485) trunks (or one N2 trunk and one BACnet MS/TP trunk); includes an internal modem. Supports up to 255 devices on the LONWORKS trunk.

1. Some models are also available in a Buy American version (add a G after the code number). For the European version, add an E after the code number. For repair parts, add -701 after the code number.

NAE85

Product Code Number	Description
MS-NIE8500-0¹	NxE85 model with 1U chassis for mounting in a server rack Note: The NAE85 models ship as MS-NIE8500-0 models. Use the ChangeModel utility in the NxE85 Metasys software to change an NIE85 to an NAE85.
MS-NxE85SW-0	NxE85 software for 10,000 objects (new projects only software)

1. Standard NxE85 models supports 10,000 objects; an upgrade is available to support an additional 15,000 objects.

Accessories

Product Code Number	Description
MS-BAT1010-0	Replacement data protection battery for NAE55 and NIE55. Rechargeable gel cell battery: 12 V, 1.2 Ah, with a typical life of 3 to 5 years at 21°C (70°F)
MS-BAT1020-0	Replacement data protection battery for NAE35, NAE45, and NCE25. Rechargeable NiMH battery: 3.6 V 500 mAh, with a typical life of 10 years at 21°C (70°F)
MS-15KUPG-0	15,000 object upgrade for NxE85
MS-MULTENGSW-6	Contains ToggleTunnel utility for converting an NAE55/NIE55 to an NAE55 model with the N2 Tunneling features enabled. Not for use with MS-NAE5510-OU or MS-NIE5510-OU.

The performance specifications are nominal and conform to acceptable industry standards. For applications at conditions beyond these specifications, consult the local Johnson Controls office. Johnson Controls, Inc. shall not be liable for damages resulting from misapplication or misuse of its products. © 2010 Johnson Controls, Inc. www.johnsoncontrols.com



Network Automation Engine (Continued)

Product Code Number	Description
MS-RAP-0	Ready Access Portal Server provides a user interface that is a natural, complementary extension of the Metasys Site Management Portal user interface. Note: This option is not necessary for sites that have an ADS/ADX that is the Site Director because Ready Access Portal Server is provided with the ADS/ADX solution.
MS-EXPORT-0	Export Utility extracts historical trend, alarm, and audit data from the system and presents the historical data in a variety of formats. Note: This option is not necessary for sites that have an ADS/ADX that is the Site Director because Export Utility is provided with the ADS/ADX solution.
AS-XFR100-1	Power transformer (Class 2, 24 VAC, 92 VA maximum output), with enclosure
AS-XFR010-1	Power transformer (Class 2, 24 VAC, 92 VA maximum output), no enclosure
SC450RM1U (OEM Part No.)	Recommended Uninterruptable Power Supply (UPS) for Nx85 Models: American Power Conversion (APC®) Smart-UPS SC 450VA, 280 W 120 VAC input/output with NEMA 5-15R output connections

Technical Specifications

NAE35 and NAE45	
Power Requirement	Dedicated nominal 24 VAC, Class 2 power supply (North America), Safety Extra-Low Voltage (SELV) power supply (Europe), at 50/60 Hz (20 VAC minimum to 30 VAC maximum)
Power Consumption	25 VA maximum
Ambient Operating Conditions	0 to 50°C (32 to 122°F); 10 to 90% RH, 30°C (86°F) maximum dew point
Ambient Storage Conditions	-40 to 70°C (-40 to 158°F); 5 to 95% RH, 30°C (86°F) maximum dew point
Data Protection	Supports data protection on power failure. Rechargeable NiMH battery: 3.6 VDC 500 mAh, with a typical life of 5 to 7 years at 21°C (70°F); Product Code Number: MS-BAT1020-0
Processor	192 MHz Renesas™ SH4 7760 RISC processor
Memory	128 MB Flash nonvolatile memory for operating system, configuration data, and operations data storage and backup 128 MB Synchronous Dynamic Random Access Memory (DRAM) for operations data dynamic memory
Operating System	Microsoft® Windows® CE embedded
Network and Serial Interfaces	One Ethernet port; 10/100 Mbps; 8-pin RJ-45 connector One optically isolated RS-485 port; 9600, 19.2k, 38.4k, or 76.8k baud (depending on protocol); with a pluggable and keyed 4-position terminal block (FC Bus available on NAE351x and NAE451x models only) One LONWORKS port; FTT10 78 Kbps; pluggable, keyed 3-position terminal block (LONWORKS port available on NAE352x-x and NAE452x models only) One RS-232-C serial port with standard 9-pin sub-D connector that supports standard baud rates. A second serial port, on models without an internal modem, that supports an optional, user-supplied external modem. One USB serial port with standard USB connector that supports an optional, user-supplied external modem. Option: One telephone port for internal modem; up to 56 Kbps; 6-pin RJ-11 connector (NAE models with an optional internal modem have one RS-232-C serial port only.)
Housing	Plastic housing material: ABS + polycarbonate UL94-5VB Protection: IP20 (IEC 60529)
Mounting	On flat surface with screws on three mounting clips or a single 35 mm DIN rail
Dimensions (Height x Width x Depth)	131 x 270 x 62 mm (5.2 x 10.6 x 2.5 in.) Minimum space for mounting NAE35 and NAE45: 210 x 350 x 110 mm (8.3 x 13.8 x 4.3 in.)
Shipping Weight	1.2 kg (2.7 lb)
Compliance	United States: UL Listed, File E107041, CCN PAZX, UL 916, Energy Management Equipment UL Listed, File S4977, UUKL 864 - 9th Edition, Smoke Control Equipment (MS-NAE35x0-2U and MS-NAE45x0-2U models only); FCC Compliant to CFR47, Part 15, Subpart B, Class A Canada: UL Listed, File E107041, CCN PAZX7, CAN/CSA C22.2 No. 205, Signal Equipment Industry Canada Compliant, ICES-003 Europe: CE Mark, EMC Directive 2004/108/EC, in accordance with EN 61000-6-3 Generic Emission Standard for Residential and Light Industry and EN 61000-6-2 Generic Immunity Standard for Heavy Industrial Environment Australia and New Zealand: C-Tick Mark, Australia/NZ Emissions Compliant BACnet International: BACnet Testing Laboratories™ (BTL) 135-2004 Listed BACnet Building Controller (B-BC)
NAE55 (Part 1 of 2)	
Power Requirement	Dedicated nominal 24 VAC, Class 2 power supply (North America), Safety Extra-Low Voltage (SELV) power supply (Europe), at 50/60 Hz (20 VAC minimum to 30 VAC maximum)
Power Consumption	50 VA maximum
Ambient Operating Conditions	0 to 50°C (32 to 122°F); 10 to 90% RH, 30°C (86°F) maximum dew point
Ambient Storage Conditions	-40 to 70°C (-40 to 158°F); 5 to 95% RH, 30°C (86°F) maximum dew point
Data Protection Battery	Supports data protection on power failure. Rechargeable gel cell battery: 12 V, 1.2 Ah, with a typical life of 3 to 5 years at 21°C (70°F); Product Code Number: MS-BAT1010-0
Clock Battery	Maintains real-time clock through a power failure. Onboard cell; typical life 10 years at 21°C (70°F)
Processor	400 MHz Pentium® class Geode® GX533 processor for MS-NAE55xx-1 models

The performance specifications are nominal and conform to acceptable industry standards. For applications at conditions beyond these specifications, consult the local Johnson Controls office. Johnson Controls, Inc. shall not be liable for damages resulting from misapplication or misuse of its products. © 2010 Johnson Controls, Inc. www.johnsoncontrols.com

Input/Output Module (IOM) Series

Description

IOMs can serve in one of two capacities depending on where they are installed in the Metasys® system. When installed on the Sensor Actuator (SA) Bus of an Field Equipment Controller (FEC) or VAV (Variable Air Volume) Modular Assembly (VMA) controller, the IOMs expand the point count of these controllers. When installed on the Field Controller (FC) Bus as point multiplexors, IOMs allow a Network Automation Engine (NAE) or Network Controller Engine (NCE) to monitor and control supervisory points directly.

A full range of FEC models combined with the IOM models can be applied to a wide variety of building applications ranging from simple fan coil or heat pump control to advanced central plant management.

Refer to the *Metasys® System Field Equipment Controllers and Related Products Product Bulletin (LIT-12011042)* for important product application information.

Features

- Large product family — provides a wide range of input/output point combinations to best fit the applications
- Ability to reside on the FC Bus or SA Bus — provides application flexibility
- Pluggable communications bus, Inputs/Outputs, and power terminals — expedite installation
- BACnet® Master-Slave/Token-Passing (MS/TP) communication — provides open system compatibility
- 32-bit microprocessor — ensures optimum performance and meets industry specifications

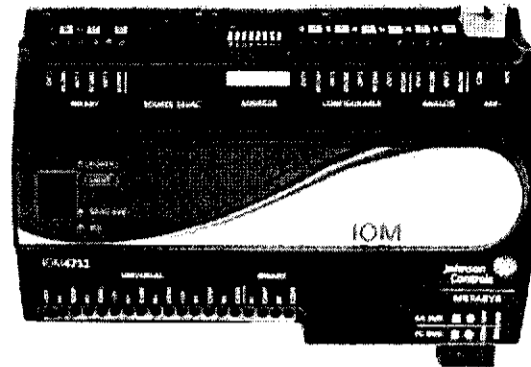

IOM47 Controller

- Wireless capabilities via ZFR1800 Series Wireless Field Bus System enable wireless mesh connectivity between IOMs to WRZ Series Wireless Room Temperature Sensors, and to NAE/NCE devices — facilitate easy initial location and relocation
- Universal and configurable inputs and outputs — support multiple signal options and increase controller application flexibility

Repair Information

If the Input/Output Module fails to operate within its specifications, replace the unit. For a replacement IOM, contact the nearest Johnson Controls® representative.

Selection Charts

IOM Series Point Type Counts per Model

Point Types	Signals Accepted	IOM17	IOM27	IOM37	IOM47
Universal Input (UI)	Analog Input, Voltage Mode, 0 - 10 VDC Analog Input, Current Mode, 4 - 20 mA Analog Input, Resistive Mode, 0 - 2k ohm, RTD (1k NI [Johnson Controls], 1k PT, A99B St), NTC (10k Type L, 2.252k Type 2) Binary Input, Dry Contact Maintained Mode	0	2	4	6
Binary Input (BI)	Dry Contact Maintained Mode Pulse Counter Mode (High Speed), 100 Hz	4	0	0	2
Analog Output (AO)	Analog Output, Voltage Mode, 0 - 10 VDC Analog Output, Current Mode, 4 - 20 mA	0	0	0	2
Binary Output (BO)	24 VAC Triac	0	0	0	3
Universal Output (UO)	Analog Output, Voltage Mode, 0 - 10 VDC Binary Output Mode, 24 V AC/DC FET Analog Output, Current Mode, 4 - 20 mA	0	2	4	0
Configurable Output (CO)	Analog Output, Voltage Mode, 0 - 10 VDC Binary Output Mode, 24 VAC Triac	0	0	0	4
Relay Output	120/240 VAC	0	2	4	0

Ordering Information

Code Number	Description
MS-IOM1711-0	4-Point IOM with 4 BI, FC Bus and SA Bus Support
MS-IOM2711-0	6-Point IOM with 2 UI, 2 UO, 2 BO, FC Bus, and SA Bus Support
MS-IOM3711-0	12-Point IOM with 4 UI, 4 UO, 4 BO, FC Bus, and SA Bus Support
MS-IOM4711-0	17-Point IOM with 6 UI, 2 BI, 3 BO, 2 AO, 4 CO, 24 VAC, and SA Bus with Mounting Base

The performance specifications are nominal and conform to acceptable industry standards. For applications at conditions beyond these specifications, consult the local Johnson Controls office. Johnson Controls, Inc. shall not be liable for damages resulting from misapplication or misuse of its products. © 2010 Johnson Controls, Inc. www.johnsoncontrols.com



Input/Output Module (IOM) Series (Continued)

Ordering Information for UL Listed, File S4977, UUKL 864 - 9th Edition, Smoke Control Equipment

Product Code Number ¹	Description
MS-IOM1710-0U	4-Point IOM with 4 BI, FC Bus and SA Bus Support
MS-IOM2710-0U	6-Point IOM with 2 UI, 2 UO, 2 BO, FC Bus, and SA Bus Support
MS-IOM3710-0U	12-Point IOM with 4 UI, 4 UO, 4 BO, FC Bus, and SA Bus Support
MS-IOM4710-0U	17-Point IOM with 6 UI, 2 BI, 3 BO, 2 AO, 4 CO, 24 VAC, and SA Bus with Mounting Base

1. These devices are UL Listed, File S4977, UUKL 864 - 9th Edition, Smoke Control Equipment.

Accessories

Code Number	Description
Y64T15-0	Transformer, 120/208/240 VAC Primary to 24 VAC Secondary, 92 VA, Foot Mount, 30 in. Primary Leads and 30 in. Secondary Leads, Class 2
Y65A13-0	Transformer, 120 VAC Primary to 24 VAC Secondary, 40 VA, Foot Mount (Y65AS), 8 in. Primary Leads and 30 in. Secondary Leads, Class 2
Y65T42-0	Transformer, 120/208/240 VAC Primary to 24 VAC Secondary, 40 VA, Hub Mount (Y65SP+), 8 in. Primary Leads and Secondary Screw Terminals, Class 2
Y65T31-0	Transformer, 120/208/240 VAC Primary to 24 VAC Secondary, 40 VA, Foot Mount (Y65AR+), 8 in. Primary Leads and Secondary Screw Terminals, Class 2
AP-TBK4SA-0	Replacement MS/TP SA Bus Terminal, 4-Position Connector, Brown, Bulk Pack
AP-TBK4FC-0	Replacement MS/TP FC Bus Terminal, 4-Position Connector, Blue, Bulk Pack
AP-TBK3PW-0	Replacement Power Terminal, 3-Position Connector, Gray, Bulk Pack
MS-BTCVT-1	Wireless Commissioning Converter, with Bluetooth® technology
MS-BTCVTCBL-700	Cable replacement Set for the MS-BTCVT-1 or the NS-ATV7003-0; includes one 5 ft (1.5 m) retractable cable.

Technical Specifications

IOM Series	
Product Code Numbers	MS-IOM1711-0 – Input/Output Module MS-IOM2711-0 – Input/Output Module MS-IOM3711-0 – Input/Output Module MS-IOM4711-0 – Input/Output Module
Supply Voltage	24 VAC (nominal, 20 VAC minimum/30 VAC maximum), 50/60 Hz, power supply Class 2 (North America), Safety Extra-Low Voltage (SELV) Europe
Power Consumption	14 VA maximum Note: VA rating does not include any power supplied to the peripheral devices connected to Binary Outputs (BOs) or Configurable Outputs (COs), which can consume up to 12 VA for each BO or CO; for a possible total consumption of an additional 84 VA (maximum).
Ambient Conditions	Operating: 0 to 50°C (32 to 122°F); 10 to 90% RH noncondensing Storage: -40 to 80°C (-40 to 176°F); 5 to 95% RH noncondensing
Addressing	DIP switch set; valid field controller device addresses 4–127 (Device addresses 0–3 and 128–255 are reserved and not valid IOM addresses).
Communications Bus	BACnet MS/TP, RS-485 3-wire FC Bus between the supervisory controller and field devices 4-wire SA Bus between field controller, network sensors, and other sensor/actuator devices, includes a lead source 15 VDC supply power (from field controller) to bus devices. ¹
Processor	H8SX/166xR Renesas® 32-bit microcontroller
Memory	IOM17, IOM27, and IOM37 Models: 640 KB Flash Memory and 128 KB Random Access Memory (RAM) IOM47 Models: 1 MB Flash Memory and 512 KB RAM

The performance specifications are nominal and conform to acceptable industry standards. For applications at conditions beyond these specifications, consult the local Johnson Controls office. Johnson Controls, Inc. shall not be liable for damages resulting from misapplication or misuse of its products. © 2010 Johnson Controls, Inc. www.johnsoncontrols.com



Input/Output Module (IOM) Series (Continued)

IOM Series	
Input and Output Capabilities	<p>IOM1711: 4 - Binary Inputs: Defined as Dry Contact Maintained or Pulse Counter/Accumulator Mode</p> <p>IOM2711: 2 - Universal Inputs: Defined as 0–10 VDC, 4–20 mA, 0–600k ohm, or Binary Dry Contact 2 - Universal Outputs: Defined as Dry Contact Maintained or Pulse Counter/Accumulator Mode 2 - Relay Outputs (Single-Pole, Double-Throw) Rate as: 240 VAC maximum voltage 1/3 hp 125 VAC, 1/2 hp 250 VAC 400 VA Pilot Duty at 240 VAC 200 VA Pilot Duty at 120 VAC 3 A Noninductive 24–240 VAC</p> <p>IOM3711: 4 - Universal Inputs: Defined as 0–10 VDC, 4–20 mA, 0–600k ohm, or Binary Dry Contact 4 - Universal Outputs: Defined as Dry Contact Maintained or Pulse Counter/Accumulator Mode 4 - Relay Outputs (Single-Pole, Double-Throw) Rate as: 240 VAC maximum voltage 1/3 hp 125 VAC, 1/2 hp 250 VAC 400 VA Pilot Duty at 240 VAC 200 VA Pilot Duty at 120 VAC 3 A Noninductive 24–240 VAC</p> <p>IOM4711: 6 - Universal Inputs: Defined as 0–VDC, 4–20 mA, 0–600k ohm, or Binary Dry Contact 2 - Binary Inputs: Defined as Dry Contact Maintained or Pulse Counter/Accumulator Mode 3 - Binary Outputs: Defined as 24 VAC Triac (selectable internal or external source power) 4 - Configurable Outputs: Defined as 0–10 VDC or 24 VAC Triac BO 2 - Analog Outputs: Defined as 0–10 VDC or 4–20 mA</p>
Analog Input/Analog Output Resolution and Accuracy	<p>Analog Input: 16-bit resolution Analog Output: 16-bit resolution and ± 200 mV in 0–10 VDC applications</p>
Terminations	<p>Input/Output: Fixed Screw Terminal Blocks SA/FC Bus and Supply Power: 4-Wire and 3-Wire Pluggable Screw Terminal Blocks SA/FC Bus Port: RJ-12 6-Pin Modular Jacks</p>
Mounting	Horizontal on single 35 mm DIN rail mount (preferred), or screw mount on flat surface with three integral mounting clips on controller
Housing	Enclosure material: ABS and polycarbonate UL94 5VB; Self-extinguishing, Plenum-rated Protection Class: IP20 (IEC529)
Dimensions (Height x Width x Depth)	<p>IOM17 and IOM27 Models: 150 x 120 x 53 mm (5-7/8 x 4-3/4 x 2-1/8 in.) including terminals and mounting clips</p> <p>IOM37 and IOM47 Models: 150 x 190 x 53 mm (5-7/8 x 7-1/2 x 2-1/8 in.) including terminals and mounting clips</p> <p>Note: For all models, mounting space requires an additional 50 mm (2 in.) space on top, bottom, and front face of controller for easy removal, ventilation, and wire terminations.</p>
Weight	0.5 kg (1.1 lb)
Compliance	<p>United States: UL Listed, File E107041, CCN PAZX, UL 916, Energy Management Equipment; FCC Compliant to CFR47, Part 15, Subpart B, Class A</p> <p>Canada: UL Listed, File E107041, CCN PAZX7, CAN/CSA C22.2 No. 205, Signal Equipment; Industry Canada Compliant, ICES-003</p> <p>Europe: CE Mark, EMC Directive 2004/108/EC, in accordance with EN 61000-6-3 (2007) Generic Emission Standard for Residential and Light Industrial and EN 61000-6-2 (2005) Generic Immunity Standard for Heavy Industrial Environment Note: For IOM17/IOM27/IOM37, Low Voltage Directive 73/23/EEC in accordance with EN 60730-1:2000/A2:2008 Automatic electrical controls for household and similar use. Note: For IOM47 Models, Conducted RF immunity within EN 61000-6-2 meets performance criteria B.</p> <p>Australia and New Zealand: C-Tick Mark, Australia/NZ Emissions Compliant</p> <p>BACnet International: BACnet Testing Laboratories (BTL) 135-2004 Listed BACnet Application Specific Controller (B-ASC)</p>

1. For more information, refer to the *MS/TP Communications Bus Technical Bulletin (LIT-12011034)*.

The performance specifications are nominal and conform to acceptable industry standards. For applications at conditions beyond these specifications, consult the local Johnson Controls office. Johnson Controls, Inc. shall not be liable for damages resulting from misapplication or misuse of its products. © 2010 Johnson Controls, Inc. www.johnsoncontrols.com

HE-67xx Series

TRUERH™ Humidity Element with Temperature Sensors

Description

The HE-67xx Series Humidity devices house both a humidity and a temperature sensor in a wall or duct-mount style. The humidity sensor is capable of measuring Relative Humidity (RH) over the entire range of 0 to 100%, and its All-Polymer™ construction provides improved resistance to chemical corrosion. The TRUERH™ product line delivers devices with RH accuracy of either ±2% or ±3% RH. TRUERH™ humidity elements produce voltage output signals proportional to measured humidity for humidity indication.

Temperature sensors are available in thin-film nickel, thin-film platinum, and silicon. The elements are powered with 14 to 30 VDC or 20 to 30 VAC and feature a user-selectable humidity output of 0 to 10 VDC or 0 to 5 VDC.

Features

- TRUERH™ circuitry and calibration techniques for which patent protection is pending

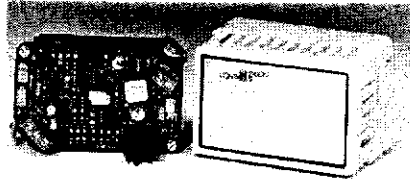

HE-67xx-0N0BT Wall Mount

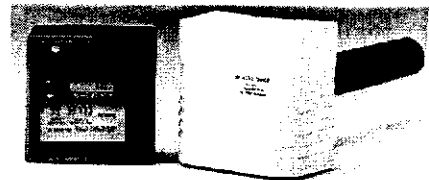

HE-67xx-0N00P Duct Probe

TRUERH™ -- True ±2% Accuracy

- All-Polymer humidity sensor patented sensing element provides accurate and reliable humidity sensing
- tested and calibrated with equipment certified to be in compliance with National Institute of Standards and Technology (NIST) guidelines
- ±2% RH accurate model includes test and calibration equipment certificate of calibration conformance
- humidity and temperature sensors in one unit eliminates the need for separate sensors and reduces installation costs
- user-selectable output voltage range allows choice of standard voltage outputs for use with systems in service or new systems
- all-plastic material for duct probe improves thermal performance and complies with Underwriters Laboratories Inc.® (UL) flammability ratings for plenum use; complies with Blue Angel (Germany) and TCO'95 (Sweden) environmental regulations

Selection Charts

HE-67xx Series Wall Mount Models

Code Number	Description	RH Accuracy	
		±2%	±3%
HE-67P2-0N0BT	Wall mount humidity element with thin-film platinum temperature sensor	■	
HE-67S2-0N0BT	Wall mount humidity element with silicon temperature sensor	■	
HE-67N2-0N0BT	Wall mount humidity element with thin-film nickel temperature sensor	■	
HE-67P3-0N0BT	Wall mount humidity element with thin-film platinum temperature sensor		■
HE-67S3-0N0BT ¹	Wall mount humidity element with silicon temperature sensor		■
HE-67N3-0N0BT	Wall mount humidity element with thin-film nickel temperature sensor		■

1. Compatible with System 350™ Humidity Controls

HE-67xx Series Duct Probe Models

Code Number	Description	RH Accuracy	
		±2%	±3%
HE-67P2-0N00P	Duct probe humidity element with thin-film platinum temperature sensor	■	
HE-67S2-0N00P	Duct probe humidity element with silicon temperature sensor	■	
HE-67N2-0N00P	Duct probe humidity element with thin-film nickel temperature sensor	■	
HE-67P3-0N00P	Duct probe humidity element with thin-film platinum temperature sensor		■
HE-67S3-0N00P ¹	Duct probe humidity element with silicon temperature sensor		■
HE-67N3-0N00P	Duct probe humidity element with thin-film nickel temperature sensor		■

1. Compatible with System 350™ Humidity Controls

Accessories for HE-67xx Wall Mount Models¹

Code Number	Description
GRD10A-608	Plastic Guard with Baseplate and Mounting Ring
T-4000-119	Allen-head Tool (30/bag)
TE-1800-9600	Wall Plate Adaptor Kit required for wallbox mounting

1. Accessories are available for the wall mount model only.

The performance specifications are nominal and conform to acceptable industry standards. For applications at conditions beyond these specifications, consult the local Johnson Controls office. Johnson Controls, Inc. shall not be liable for damages resulting from misapplication or misuse of its products. © 2009 Johnson Controls, Inc. www.johnsoncontrols.com



TRUERH™ Humidity Element with Temperature Sensors (Continued)

Technical Specifications

HE-67xx Series TRUERH™ Humidity Element with Temperature Sensors		
Power Requirements		
14 to 30 VDC or 20 to 30 VAC at 50/60 Hz, Class 2		
Current Draw		
3 mA with no load, 25 mA maximum		
Acceptable Wire Gauge		
16 to 24 AWG (18 AWG recommended)		
Humidity Element at 77°F (25°C)	Signal	0 to 5 VDC or 0 to 10 VD, 1,000 ohm maximum load
	Accuracy	HE-67x2: ±2% RH for 20 to 80% RH at 77°F (25°C) ±4% RH for 10 to 20% and 80 to 90% RH at 77°F (25°C) HE-67x3: ±3% RH for 20 to 80% RH at 77°F (25°C) ±5% RH for 10 to 20% and 80 to 90% RH at 77°F (25°C)
	Temperature Coefficient	0.1 to 0.05% RH/°C at 5°C (41°F) to -0.07 to -0.21% RH/°C at 65°C (149°F)
	Response Time	Within 5% RH of actual in 15 minutes for 10 to 30%, 30 to 90%, and 40 to 90% RH
Temperature Sensors	Thin-film Nickel	Accuracy: ±0.34°F (0.18°C) at 70°F (21°C) Reference Resistance: 1000 ohms at 70°F (21°C) Resistance Change: Approximately 3 ohms/°F (5 ohms/°C)
	Silicon	Accuracy: ±1°F (0.6°C) at 70°F (21°C) Reference Resistance: 1035 ohms at 77°F (25°C) Resistance Change: Approximately 4 ohms/°F (8 ohms/°C)
	Thin-film Platinum	Accuracy: ±0.65°F at 70°F (±0.36°C at 21°C) Reference Resistance: 1000 ohms at 32°F (0°C) Resistance Change: Approximately 2 ohms/°F (4 ohms/°C)
Electrical Connections		3-position and 2-position screw terminal blocks
Ambient Operating Conditions		32 to 140°F (0 to 60°C) 0 to 100% RH, 85°F (29.4°C) maximum dew point
Survival Operating Conditions		-20 to 140°F (-29 to 60°C) 0 to 100% RH, 85°F (29.4°C) maximum dew point
Ambient Storage Conditions		-40 to 140°F (-40 to 60°C) 0 to 100% RH, 85°F (29.4°C) maximum dew point
Materials	Wall Mount	Beige plastic cover with metal base and metal foil face plates
	Duct Probe	White plastic cover with dark gray plastic housing and probe
Dimensions	Wall Mount (H x W x D)	1.81 x 2.12 x 3.12 in. (46 x 54 x 79 mm)
	Duct Probe (H x W x D)	3.28 x 3.25 x 8.27 in. (83 x 83 x 210 mm) Probe (L x D): 6.25 x 0.98 in. (159 x 25 mm)
Agency Compliance	Duct Probe Material	94-5V flammability rated per UL 94

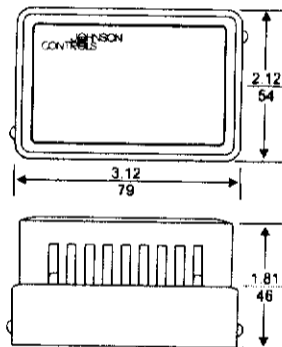

Wall Mount Humidity Element Dimensions, in. (mm)

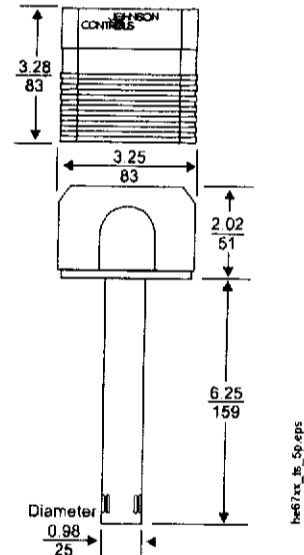

Duct Probe Humidity Element Dimensions, in. (mm)

The performance specifications are nominal and conform to acceptable industry standards. For applications at conditions beyond these specifications, consult the local Johnson Controls office. Johnson Controls, Inc. shall not be liable for damages resulting from misapplication or misuse of its products. © 2009 Johnson Controls, Inc. www.johnsoncontrols.com

APPROVAL OF RFP 10-207 SECURITY CAMERA SYSTEM FOR BREWSTER SCHOOL ADDITIONS, EDINBURG HIGH SCHOOL, ECONOMEDES HIGH SCHOOL, AND EDINBURG NORTH HIGH SCHOOL FINE ARTS BUILDINGS

Superintendent's Recommendation

That the Board of Trustees approves the RFP 10-207 Security Camera System for Brewster School Additions, Edinburg High School, Economedes High School, and Edinburg North High School Fine Arts Buildings as prepared by Broaddus & Associates.

Rationale

The proposals submitted by sub-contractors, for the project referred to above, were reviewed and evaluated on Wednesday, October 6, 2010. Attached, for your review and consideration are the results of the evaluation.

Based on the results, Broaddus and Associates respectfully request that the ECISD Board of Trustees consider approving the ranking and that we be allowed to negotiate a contract for the Security Camera Systems beginning with the highest ranked proposer, Superior Alarms at \$173,731.96.

The Facilities Committee has reviewed this item and recommends Board approval.

Budgetary Information

Account Number	Appropriation	Encumbrance	Expenditure	Balance
623-81-6629-00-102-199	\$ 1,050,240.00	\$ 375,732.00	\$602,583.00	\$ 71,925.00
623-81-6629-00-001-199	\$ 2,039,444.00	\$1,047,262.71	\$959,953.14	\$ 32,228.15
623-81-6629-00-002-199	\$1,386,317.00	\$ 607,593.64	\$739,368.13	\$ 39,355.23
623-81-6629-00-003-199	\$1,449,945.00	\$ 436,709.65	\$982,688.73	\$ 30,546.62

Resource Personnel

Facilities Committee
 Dr. Rene Gutiérrez
 Mario Salinas
 Sylvia Garcia
 Robert Estrada

Board Policy Reference

This is in accordance with Board Policy BAA (Legal) Board Powers and Duties.

Prepared by:

 Robert Estrada, District Architect

Approved by:

 Mario Salinas, Asst. Superintendent for District Administration

Within Budgetary Allocations:

 Sylvia Garcia, Director of Finance

Recommended by:



 Dr. Rene Gutierrez, Superintendent of Schools

Exhibit _____, Pages _____

**BROADDUS
& ASSOCIATES**
INTEGRATED PROJECT MANAGEMENT AND CONSULTING

11/17/2010

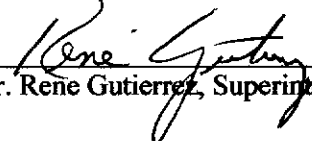
Dr. Rene Gutierrez, Ed.D.
Superintendent of Schools
Edinburg Consolidated Independent School District
411 N. 8th St.
Edinburg, TX 78541

Re: ECISD 2008 Bond Program
New Fine Arts Facilities and Brewster Campus Classroom Wing & Gymnasium
Security Camera System Proposal Evaluation

Dear Mr. Gutierrez:

The proposals submitted by sub-contractors, for the project referred to above, were reviewed and evaluated on Wednesday October 6, 2010. Attached, for your review and consideration are the results of the evaluation.

Based on these results, Broaddus & Associates respectfully requests that the ECISD Board of Trustees consider approving the ranking and that we be allowed to negotiate a contract for the Security Camera Systems beginning with the highest ranked proposer, Superior Alarms at \$173,731.96.

1	Superior Alarms
2	All American Security
3	Security International
4	Argus Security

Please contact me if you have any questions or if you require any additional information.

Sincerely,



Rolando L. Garcia, FAIA
Senior Project Manager, LEED AP

FN: 101130 ECISD Security Cams Recom Let.docx

1100 E. Jasmine Ave. ♦ McAllen, Texas 78501 ♦ Phone: (956) 688-2307 ♦ Fax: (956) 688-2315

1301 S. Capital of Texas Highway, Suite A-302 ♦ Austin, Texas 78746 ♦ Phone: (512) 329-8822 ♦ Fax: (512) 329-8242

EXHIBIT _____

**RFP 10-207, SECURITY CAMERA SYSTEM FOR BREWSTER, EDINBURG HIGH SCHOOL,
ECONOMEDES HIGH SCHOOL & EDINBURG NORTH HIGH SCHOOL
EVALUATION QUESTIONNAIRE**

		All American Security, LLC	PTS	Argus Security	PTS	Security International	PTS	Superior Alarms	PTS
1	PROPOSED PRICE FOR SPECIFIED SYSTEM LISTED BELOW								
	a. Brewster Security System	70,098.00		64,950.00		54,260.00		71,604.13	
	b. Edinburg High Performing Arts Center Security System	46,328.00		41,950.00		29,160.00		32,227.75	
	c. Edinburg North Performing Arts Center Security System	41,731.00		37,950.00		25,850.00		30,545.28	
	d. Economedes Performing Arts Center Security System	49,959.00		40,950.00		33,635.00		39,354.80	
	50 PTS. - TOTAL ON PRICE	208,116.00	35	185,800.00	40	142,905.00	49.5	173,731.96	45
2	QUALIFICATIONS								
	a. Can you work after 4:00 p.m. and on Saturdays, if required?	yes	5	yes	5	yes	5	yes	5
	b. Does your company have the ability to be accessed via Ethernet to monitor and to remotely make adjustments to security cameras?	yes	5	yes	5	yes	5	yes	5
	c. Does your company have the ability to provide CAD documents showing locations of all cameras and wiring layout?	yes	5	yes	5	yes	5	yes	5
	d. How long before you answer a service call?	4 hours	5	8 hours	3.5	24-48 hours	2.5	4 hours	5
	e. How long will it take to complete the jobs?	25 days	4	21 days	5	30 days	3	40 days	2.25
	f. List the type of training your company will provide to the District:	Operation & Maintenance, Storage & Transfers of Video File	4.5	4 hour training session, web based training through Pelco web	4.75	Comprehensive training of all systems installed, training manuals	5	Operator training on DVR usage, camera control and function	4.75
	30 PTS. TOTAL		28.5		28.5		25.5		27
3	PAST EXPERIENCE WITH SCHOOL DISTRICTS	yes	20	yes	11	yes	8	yes	18
	20 PTS. TOTAL		20		11		8		18
	TOTAL POINTS		83.5		79.5		83		90

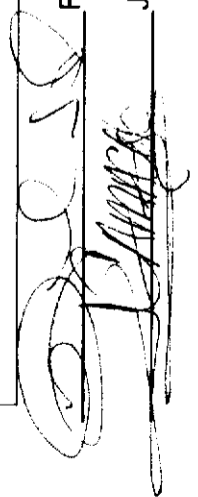

Rolando Garcia, FAIA

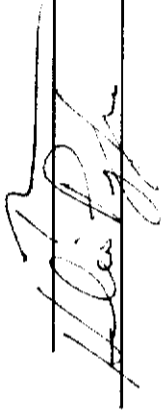

Tim Weldon, Project Manager

Julio Camacho, Communications Specialist

Heralio Perez, Jr., Project Manager