

Agenda of Board Workshop/Regular Meeting

The Board of Trustees Mineral Wells ISD

A Board Workshop/Regular Meeting of the Board of Trustees of Mineral Wells ISD will be held Monday, June 12, 2023, beginning at 5:30 PM in the District Services Complex.

The subjects to be discussed or considered or upon which any formal action may be taken are listed below. Items do not have to be taken in the same order as shown on this meeting notice. Unless removed from the consent agenda, items identified within the consent agenda will be acted on at one time.

1. Call to Order/Establish Quorum

2. Oath of Office for Elected Board Members

Presenter: Shelia Crabtree, Notary Public

- A. Brandon Hons - Place 2
- Lauretta Poole - Place 6
- Maria Jones - Place 7

3. Board Internal Organization

Presenter: Maria Jones, Board President

4. Board Workshop/Dinner

- A. Agenda Review
- B. Planning for 23-24 School Year

5. Closed Session - Texas Government Code 551.074, Texas Government Code 551.076, Texas Government Code 551.082 and Texas Government Code 551.072

A. Texas Government Code 551.074

- 1) Employment/Appointment/Reassignment/Evaluation/Compensation/Duties of Personnel
- 2) Renewal/Nonrenewal/Assignment/Reassignment/Probationary Status/Return to Probationary Status/Continuing Status of District Personnel

B. Texas Government Code 551.076

- 1) Security - Personnel, Devices, Audits

C. Texas Government Code 551.082

- 1) Student Discipline

6. Open Session - 7:00 p.m.

7. Prayer

8. Pledges - U.S./Texas Flags	
9. Mission & Vision Statements	
10. Special Recognition	
Presenter: Karyn Bullock, Communications Director	
11. Public Comment	
12. President's Report	
A. Summer Leadership Institute June 21-24 - Fort Worth	
13. Superintendent's Report	
A. Enrollment Comparison	4
B. A-F Refresh	
Presenter: Angie Myrick, Executive Director of Curriculum	
14. Consent Agenda Items	
A. Monthly Financial Reports and Accounts Payable Listing	7
B. Water/Electricity/Gas Reports	26
C. Minutes of the May 8, 2023 Regular Meeting of the Board, May 4, 2023 Special Meeting of the Board, May 19, 2023 Special Meeting of the Board, and May 30, 2023, Special Meeting of the Board	30
D. Proposed Budget Calendar	37
Presenter: Paul Hearn, Chief Financial Officer	
E. Interlocal Agreement for Palo Pinto Assessment and Collection Services	39
Presenter: Paul Hearn, Chief Financial Officer	
15. FIRST READING: Localized Policy Manual Update 121	44
Presenter: Dr. John Kuhn, Superintendent	
16. Discuss, Consider, and Take Any Necessary Action Regarding Authorizing the Superintendent to Take All Action Necessary to Ensure the Installation of a Replacement Portable Classroom at Travis Elementary	55
Presenter: Dr. John Kuhn, Superintendent	
17. Discuss, Consider, and Take Any Necessary Action Regarding Authorizing the Superintendent to Take All Actions Necessary for Ensuring the Installation or Construction of a Replacement High School Greenhouse	81
Presenter: Dr. John Kuhn, Superintendent	
18. Discuss, Consider, and Take Any Necessary Action Regarding Proposal for Professional Services Between Jacob/Martin and MWISD	99
Presenter: Dr. John Kuhn, Superintendent	
19. Discuss, Consider, and Take Any Necessary Action Regarding a Waiver for Staff Development in Place of Student Instruction for up to 2,100 minutes during the 2023-2024 School Year	103
Presenter: Angie Myrick, Executive Director of Curriculum	
20. Discuss, Consider, and Take Any Necessary Action Regarding the Education Service Center Region 11 Contract for Services for the 2023-2024 School Year	104

Presenter: Dr. John Kuhn, Superintendent	
21. Discuss Proposed Board Review of LOCAL policies (Discussion Item Only)	107
Presenter: Dr. John Kuhn, Superintendent	
22. Discuss, Consider, and Take Any Necessary Action Regarding the 2023-2024 Compensation Plan	110
Presenter: David Tarver, Assistant Superintendent	
23. Discuss, Consider, and Take Any Necessary Action Regarding Chromebook Purchase for the 2024-2025 School Year	128
Presenter: Justin Lascsak, Technology Director	
24. Discuss, Consider, and Take Any Necessary Action Regarding the Optional Flexible School Day	131
Presenter: Shanna Spillers, High School Principal	
25. Information	
A. Calendars for June and July	163
26. Vote on Closed Session Items	
27. Adjournment	



BOARD OF TRUSTEES Agenda Item

MEETING DATE: 6/12/23

MEETING TYPE:

- Regular Meeting
- Special Meeting

AGENDA ITEM TYPE:

- Action Item
- Non-Action Item

BOARD GOALS (check all that apply)

Academic Goals

- Academic Competitiveness
 - Early Literacy (HB3)
 - Early Math (HB3)
 - Other
- Career Certifications (HB3)

Operational Goals

- Promote Community/School Partnerships
- Fiscal Responsibility
- Safe and Secure Schools

TITLE: Enrollment Comparison

RECOMMENDED ACTION: This item is for information only.

BOARD POLICY/STATE REGULATION/LAW REFERENCE (if applicable):

OVERVIEW:

See attached information

FISCAL IMPACT: Rising enrollment results in revenue increase

ATTACHMENTS: Enrollment Report for May 2023

DEPARTMENT(S) SUBMITTING FORM: Superintendent

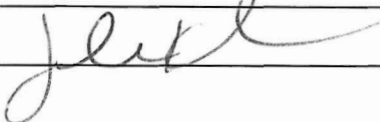
DEPARTMENT SIGNATURE/APPROVAL: 

Mineral Wells I.S.D. Campus Summary Report as of May 25th (18 school days)

Total # of Students:	3328
Refined ADA:	2952.95
% of Attendance:	93.26%

School	Student Enrollment	Refined ADA	% Attendance
Mineral Wells H.S.	860	782.61	91.67%
Academy	18	16.17	69.78%
Mineral Wells JH	494	459.56	93.02%
Travis Elementary	742	698.22	94.11%
Houston Elementary	494	469.67	94.85%
Lamar Elementary	720	526.72	94.17%

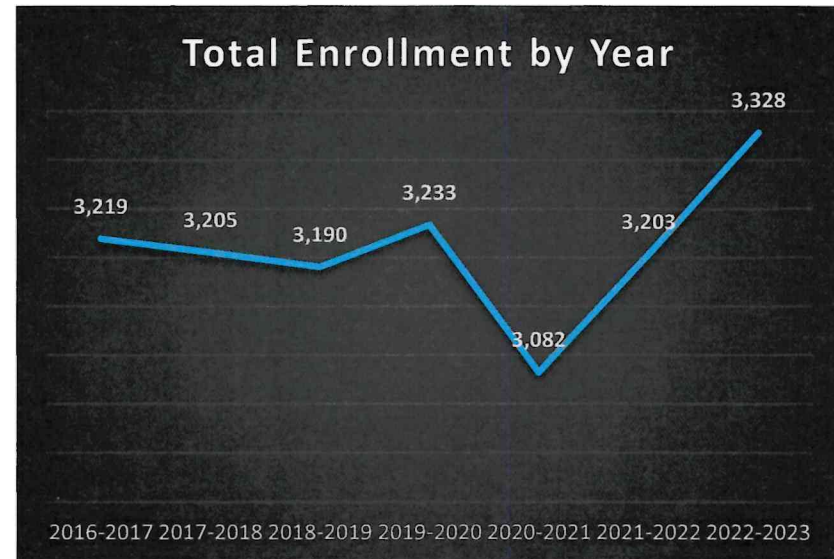
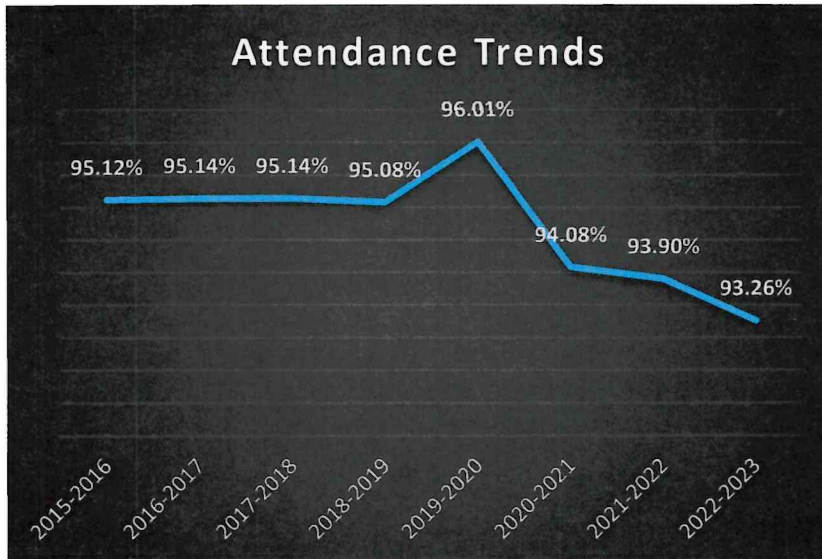

May 2023

	2016-2017	2017-2018	2018-2019	2019-2020	2020-2021	2021-2022	2022-2023
	May	May	May	May	May	May	May
EE	31	29	18	32	30	26	20
PK	224	218	221	217	146	206	204
K	203	266	246	265	245	206	264
1st	235	208	265	253	240	260	232
2nd	267	229	206	250	247	233	252
3rd	223	259	225	209	244	243	242
4th	260	231	242	225	206	244	262
5th	261	252	231	244	210	222	259
6th	217	261	250	229	242	225	221
7th	228	219	264	270	238	248	241
8th	214	222	226	253	261	245	253
9th	221	201	223	239	241	280	268
10th	226	208	190	199	208	217	242
11th	207	208	176	152	171	175	193
12th	178	182	197	160	136	156	157
Academy	24	12	10	36	17	17	18
Total	3,219	3,205	3,190	3,233	3,082	3,203	3,328

Attendance Comparison by Year

	2015-2016	2016-2017	2017-2018	2018-2019	2019-2020	2020-2021	2021-2022	2022-2023
MWHS	94.75%	94.52%	94.19%	93.95%	95.15%	91.41%	89.33%	91.67%
Academy	81.87%	82.51%	82.90%	71.11%	83.10%	74.29%	81.04%	69.78%
JH	95.02%	95.22%	94.75%	94.79%	96.40%	96.88%	95.01%	93.02%
Travis	95.95%	95.97%	95.54%	95.65%	96.53%	93.91%	95.81%	94.11%
Houston	95.33%	96.06%	95.94%	95.54%	97.01%	96.05%	93.65%	94.85%
Lamar	94.95%	94.78%	95.77%	95.95%	95.86%	94.35%	95.65%	94.17%
TOTAL	95.12%	95.14%	95.14%	95.08%	96.01%	94.08%	93.90%	93.26%



BOARD OF TRUSTEES Agenda Item

MEETING DATE: 6/12/23

MEETING TYPE:

- Regular Meeting
- Special Meeting

AGENDA ITEM TYPE:

- Action Item
- Non-Action Item

BOARD GOALS (check all that apply)

Academic Goals

- Academic Competitiveness
 - Early Literacy (HB3)
 - Early Math (HB3)
 - Other
- Career Certifications (HB3)

Operational Goals

- Promote Community/School Partnerships
- Fiscal Responsibility
- Safe and Secure Schools

TITLE: Discuss, Consider, and Take Any Necessary Action Regarding the Monthly Financial Reports and Accounts Payable Listing

RECOMMENDED ACTION: It is recommended that the monthly Financial Reports and Accounts Payable Listing be approved as presented.

BOARD POLICY/STATE REGULATION/LAW REFERENCE (if applicable):

OVERVIEW:

See attached information.

FISCAL IMPACT: Variable revenue and expenditures to District

ATTACHMENTS: Tax Receipt Report, Financial Statement, AP Listing

DEPARTMENT(S) SUBMITTING FORM: Business and Finance

DEPARTMENT SIGNATURE/APPROVAL:

**June 10, 2023 BOARD MEETING
2022-2023 TAX COLLECTIONS
AS Of APRIL 30, 2023**

MAINTENANCE & OPERATIONS						
	LEVY	MONTHLY ACTIVITY	PRIOR ACTIVITY	YEAR-TO-DATE ACTIVITY	BALANCE DUE	YEAR-TO-DATE PERCENTAGE COLLECTED
CURRENT TAXES	\$ 11,407,590.00	\$ 173,048.38	\$ 11,230,839.93	\$ 11,403,888.31	\$ 3,701.69	99.97%
DELINQUENT TAXES	\$ 283,388.00	\$ 7,092.53	\$ 238,458.27	\$ 245,550.80	\$ 37,837.20	86.65%
PENALTY & INTEREST	\$ 198,502.69	\$ 19,711.97	\$ 136,447.86	\$ 156,159.83	\$ 42,342.86	78.67%
GRAND TOTAL	\$ 11,889,480.69	\$ 199,852.88	\$ 11,605,746.06	\$ 11,805,598.94	\$ 83,881.75	99.29%

INTEREST & SINKING						
	LEVY	MONTHLY ACTIVITY	PRIOR ACTIVITY	YEAR-TO-DATE ACTIVITY	BALANCE DUE	YEAR-TO-DATE PERCENTAGE COLLECTED
CURRENT TAXES	\$ 3,445,627.00	\$ 52,268.73	\$ 3,392,240.20	\$ 3,444,508.93	\$ 1,118.07	99.97%
DELINQUENT TAXES	\$ 87,755.00	\$ 2,286.97	\$ 79,160.84	\$ 81,447.81	\$ 6,307.19	92.81%
PENALTY & INTEREST	\$ 61,647.00	\$ 5,867.66	\$ 38,965.97	\$ 44,833.63	\$ 16,813.37	72.73%
GRAND TOTAL	\$ 3,595,029.00	\$ 60,423.36	\$ 3,510,367.01	\$ 3,570,790.37	\$ 24,238.63	99.33%

**MINERAL WELLS INDEPENDENT SCHOOL DISTRICT
CASH POSITION**

FOR PERIOD ENDING APRIL 30, 2023

GENERAL FUND	\$ 4,157,877.49
FOOD SERVICE	\$ 363,367.56
SPECIAL REVENUE	\$ 1,648,827.90
INTEREST & SINKING	\$ 156,742.74
INSURANCE FUND	\$ 397,148.56
WORKERS' COMPENSATION	\$ 37.55
TRUST & AGENCY FUND	\$ 187,395.23
PAYROLL	<u>\$ (97,741.24)</u>
TOTAL	\$ 6,813,655.79

Lone Star Investment

General Fund	\$ 6,225,928.36
Food Service Fund	\$ 3.96
Interest & Sinking	\$ 1,548,465.23
Insurance Fund	<u>\$ 96,107.19</u>

TOTAL INVESTMENTS **\$ 7,870,504.74**

MINERAL WELLS ISD
COMPARISON OF REVENUE/OTHER RESOURCES TO BUDGET (Date: 4/2023)

<u>Fnd</u>	<u>Fnd</u>	CASH <u>RECEIVED</u>	2022-2023 <u>Budget</u>	<u>Balance</u>
180	CO-CURRICULAR	213,625.65	143,636.00	-69,989.65
199	GENERAL FUND	25,257,863.04	34,913,691.00	9,655,827.96
211	TITLE I, PART A	380,039.16	1,183,962.00	803,922.84
224	IDEA-B FORMULA	375,922.77	813,510.00	437,587.23
225	IDEA-B PRESCHOOL	8,491.75	30,706.00	22,214.25
240	FOOD SERVICE	1,559,186.58	2,238,912.00	679,725.42
244	CARL PERKINS BASIC FORM. GRANT	42,906.10	53,493.00	10,586.90
255	TITLE II, PART A-SUP EFF INSTR	73,714.59	187,577.00	113,862.41
263	Title III, PART A-ELA	13,436.80	80,567.00	67,130.20
266	ESSER GRANT	213.36	214.00	0.64
270	TITLE V,B,SP 2, RLIS	18,124.57	115,794.00	97,669.43
281	ESSER II PPRP	1,311,264.29	1,825,688.00	514,423.71
282	ESSER III	1,243,409.56	3,733,551.00	2,490,141.44
284	IDEA-B FORMULA-ARP	0.00	44,632.00	44,632.00
285	IDEA-B PRESCHOOL-ARP	0.00	6,474.00	6,474.00
289	FEDERALLY FUNDED SPECIAL REV	44,442.20	118,345.00	73,902.80
364	IDEA PART B, FORMULA ARP	16,063.66	16,063.00	-0.66
365	IDEA PART B, PRESCHOOL ARP	203.36	203.00	-0.36
397	ADVANCED PLACEMENT INCENTIVES	0.00	55.00	55.00
410	STATE TEXTBOOK FUND	68,588.75	103,968.00	35,379.25
429	STATE FUNDED SPECIAL REVENUE	0.00	283,251.00	283,251.00
455	SHARS-MEDICAID	549,881.64	829,665.00	279,783.36
461	CAMPUS ACTIVITY FUND	23,938.81	23,933.00	-5.81
599	DEBT SERVICE	3,678,480.17	3,598,161.00	-80,319.17
753	INSURANCE FUND	8,923.78	13,479.00	4,555.22
880	CUSTODIAL FUND - SCHOLARSHIPS	9,435.81	10,870.00	1,434.19
Grand Revenue Totals		34,898,156.40	50,370,400.00	15,472,243.60

Fnd	Fnd	Expended	Encumbered	2022-2023	
				Budget	Balance
180	CO-CURRICULAR	1,068,947.89	54,319.28	1,308,327.00	185,059.83
199	GENERAL FUND	20,927,803.12	288,768.91	33,749,000.00	12,532,427.97
211	TITLE I, PART A	638,715.67	300.00	1,183,962.00	544,946.33
224	IDEA-B FORMULA	624,082.82	25,550.00	813,510.00	163,877.18
225	IDEA-B PRESCHOOL	13,423.42	0.00	30,706.00	17,282.58
240	FOOD SERVICE	1,451,895.35	1,793.47	2,238,912.00	785,223.18
244	CARL PERKINS BASIC FORM. GRANT	45,453.08	4,195.64	53,493.00	3,844.28
255	TITLE II, PART A-SUP EFF INSTR	104,017.39	575.00	187,577.00	82,984.61
263	Title III, PART A-ELA	19,691.43	3,935.84	80,567.00	56,939.73
266	ESSER GRANT	213.36	0.00	214.00	0.64
270	TITLE V,B,SP 2, RLIS	21,461.24	0.00	115,794.00	94,332.76
281	ESSER II PPRP	1,355,251.58	230,329.86	1,825,688.00	240,106.56
282	ESSER III	2,034,222.70	0.00	3,733,551.00	1,699,328.30
285	IDEA-B PRESCHOOL-ARP	0.00	0.00	6,474.00	6,474.00
289	FEDERALLY FUNDED SPECIAL REV	57,573.58	0.00	118,345.00	60,771.42
364	IDEA PART B, FORMULA ARP	16,063.66	0.00	16,063.00	-0.66
365	IDEA PART B, PRESCHOOL ARP	203.36	0.00	203.00	-0.36
397	ADVANCED PLACEMENT INCENTIVES	0.00	0.00	55.00	55.00
410	STATE TEXTBOOK FUND	42,488.75	26,565.00	103,968.00	34,914.25
429	STATE FUNDED SPECIAL REVENUE	6,502.75	0.00	283,251.00	276,748.25
455	SHARS-MEDICAID	17,532.79	0.00	829,665.00	812,132.21
461	CAMPUS ACTIVITY FUND	10,402.74	2,461.48	21,218.00	8,353.78
599	DEBT SERVICE	2,793,899.31	0.00	3,598,161.00	804,261.69
880	CUSTODIAL FUND - SCHOLARSHIPS	3,100.00	0.00	9,650.00	6,550.00
Grand Expense Totals		31,252,945.99	638,794.48	50,308,354.00	18,416,613.53

Number of Accounts: 1823

Fnd	T	Fn	Obj	Sb	Org	F	Pr	L	L2	Obj	2022-2023	YTD	Encumbered	Unencumbered
											BUDGET	EXPENDED	Amount	Balance
XXX	E	00	----	--	----	-	--	-	----	----	807,053.00	0.00	0.00	807,053.00
XXX	E	11	----	--	----	-	--	-	----	----	26,925,900.00	15,139,821.15	192,960.14	11,593,118.71
XXX	E	12	----	--	----	-	--	-	----	----	1,764,120.00	1,187,896.42	49,403.24	526,820.34
XXX	E	13	----	--	----	-	--	-	----	----	469,133.00	260,760.08	8,176.92	200,196.00
XXX	E	21	----	--	----	-	--	-	----	----	230,557.00	163,441.03	3,117.39	63,998.58
XXX	E	23	----	--	----	-	--	-	----	----	2,341,468.00	1,514,400.33	13,300.30	813,767.37
XXX	E	31	----	--	----	-	--	-	----	----	938,814.00	717,829.41	3,375.79	217,608.80
XXX	E	33	----	--	----	-	--	-	----	----	405,138.00	243,851.27	4,061.64	157,225.09
XXX	E	34	----	--	----	-	--	-	----	----	1,184,248.00	886,303.02	17,717.22	280,227.76
XXX	E	35	----	--	----	-	--	-	----	----	2,262,312.00	1,466,745.35	1,793.47	793,773.18
XXX	E	36	----	--	----	-	--	-	----	----	1,341,128.00	1,093,461.64	54,319.28	193,347.08
XXX	E	41	----	--	----	-	--	-	----	----	1,510,052.00	1,154,123.70	23,908.94	332,019.36
XXX	E	51	----	--	----	-	--	-	----	----	5,569,803.00	3,893,025.14	239,692.13	1,437,085.73
XXX	E	52	----	--	----	-	--	-	----	----	297,867.00	56,299.71	1,118.02	240,449.27
XXX	E	53	----	--	----	-	--	-	----	----	204,956.00	170,864.46	0.00	34,091.54
XXX	E	61	----	--	----	-	--	-	----	----	66,281.00	3,502.06	300.00	62,478.94
XXX	E	71	----	--	----	-	--	-	----	----	3,714,010.00	2,988,070.55	0.00	725,939.45
XXX	E	93	----	--	----	-	--	-	----	----	102,200.00	76,650.00	25,550.00	0.00
XXX	E	97	----	--	----	-	--	-	----	----	208,296.00	232,800.67	0.00	-24,504.67
Grand Expense Totals											50,343,336.00	31,249,845.99	638,794.48	18,454,695.53

Number of Accounts: 1816

***** End of report *****

<u>VENDOR</u>	<u>INVOICE NUMBER</u>	<u>INVOICE DESCRIPTION</u>	<u>CHECK DATE</u>	<u>CHECK NUMBER</u>	<u>CHE TYP</u>	<u>AMOUNT</u>
EDUCATION SERVICE CT	Multiple	Multiple Invoices	05/08/2023	98789	V	-9,270.00
ROSA'S CAFE & TORTIL	19880761	Fajita Luncheon for Teacher Appreciation Week	05/03/2023	99053	R	1,221.52
A FIRE AND SECURITY	332021-R	DSC Fire Alarm Replacement	05/04/2023	99054	R	7,393.30
AIRGAS USA, LLC	Multiple	Multiple Invoices	05/04/2023	99055	R	1,623.88
ALLSTAR CUSTOM APPAR	Multiple	Multiple Invoices	05/04/2023	99056	R	980.75
AWARDS & MORE ENGRAV	Multiple	Multiple Invoices	05/04/2023	99057	R	2,447.00
BARBEE, BRITTANY	001	JUDGE	05/04/2023	99058	R	150.00
BILL'S DIESEL & WREC	Multiple	Multiple Invoices	05/04/2023	99059	R	570.00
BUCKS WHEEL & EQUIP	125767	TRANSPORTATION - SUPPLY	05/04/2023	99060	R	397.56
CANDEE PETRIE SPARKS	105	T Shirts for entire staff for new school year	05/04/2023	99061	R	1,818.00
ELAN FINANCIAL SERVI	Multiple	Multiple Invoices	05/04/2023	99063	R	1,380.43
ELAN FINANCIAL SERVI	Multiple	Multiple Invoices	05/04/2023	99063	V	-1,380.43
CAROLINA BIOLOGICAL	Multiple	Multiple Invoices	05/04/2023	99064	R	825.05
Carroll, DONNA	001	JUDGE	05/04/2023	99065	R	150.00
CROSS TIRE AND AUTOM	Multiple	Multiple Invoices	05/04/2023	99066	R	4,878.19
CROSS, MICHAEL	0430	TRANSPORTATION - EMPLOYEE REIMBURSEMENT FOR CDL RENEWAL	05/04/2023	99067	R	97.00
CROSS PLAINS OIL FIE	527463	MAINTENANCE-April 2023	05/04/2023	99068	R	530.66
DEMCO, INC	Multiple	Multiple Invoices	05/04/2023	99069	R	3,442.40
DIRECTATHLETICS, INC	20742	SUPPLIES	05/04/2023	99070	R	192.75
DISA GLOBAL SOLUTION	2289326	DRUG TEST	05/04/2023	99071	R	392.00
ELLIOTT ELECTRIC SUP	Multiple	Multiple Invoices	05/04/2023	99073	R	1,823.46
ERWIN HEALTH CARE, I	844	TRANSPORTATON - DOT PHYSICALS FOR TRANSPORTATION EMPLOYEES/DRIVERS ***** OPEN PURCHASE ORDER FOR THE SCHOOL YEAR 2022-2023 ***** PURCHASE ORDER WILL CLOSE ON AUGUST 31, 2023	05/04/2023	99074	R	225.00
EWELL EDUCATIONAL SE	Multiple	Multiple Invoices	05/04/2023	99075	R	718.00
FAMOUS MINERAL WATER	Multiple	Multiple Invoices	05/04/2023	99076	R	384.40
FOOD SERVICE	Multiple	Multiple Invoices	05/04/2023	99078	R	2,375.46
FORT WORTH SHAVER	46134	Clipper Blade Sharpening	05/04/2023	99079	R	100.00
Fowler, Kendra	0503	Meals and Mileage SPED Director Meeting 5-10-23	05/04/2023	99080	R	79.63
Geer, Rebeka	0430	Fingerprint Reimbursement Educational Aide Certs	05/04/2023	99081	R	71.47
GRADUATE SALES, INC	Multiple	Multiple Invoices	05/04/2023	99082	R	1,456.50
HOUGHTON MIFFLIN GRE	Multiple	Multiple Invoices	05/04/2023	99083	R	7,916.81
INTERSTATE BILLING S	Multiple	Multiple Invoices	05/04/2023	99084	R	1,051.92
JODIE'S ALTERNATOR	703	TRANSPORTATION - PARTS	05/04/2023	99085	R	250.00
KYOCERA DOCUMENT SOL	Multiple	Multiple Invoices	05/04/2023	99086	R	3,862.89
La Cienega	Multiple	Multiple Invoices	05/04/2023	99087	R	795.00
LONE STAR COMMUNICAT	129228	HS outdoor horn replacement	05/04/2023	99088	R	802.37
MATHESON TRI-GAS	0027615134	TRANSPORTATION - SUPPLY	05/04/2023	99089	R	41.58
McDaniel, Ricky	0430	TRANSPORTATION - EMPLOYEE REIMBURSEMENT FOR CDL RENEWAL	05/04/2023	99090	R	97.00
Mendez-Vergara, Ruth	0331	March Contracted services	05/04/2023	99091	R	1,119.36
MERRIMAC & NORTH	0504	Cookie and Cake Box for Teacher Appreciation Week	05/04/2023	99092	R	400.00
MIKE'S WESTSIDE RENT	w5082-2	TRANSPORTATION - CONTRACTED MAINTENANCE AND REPAIR	05/04/2023	99093	R	342.32
MINERAL WELLS HIGH S	JW2	MWHS Construction Trades Ram	05/04/2023	99094	R	138.03

<u>VENDOR</u>	<u>INVOICE NUMBER</u>	<u>INVOICE DESCRIPTION</u>	<u>CHECK DATE</u>	<u>CHECK NUMBER</u>	<u>CHE TYP</u>	<u>AMOUNT</u>
		Woodworking Church Pew				
NORTHSTAR AUTOMOTIVE	13061	Tire Changer	05/04/2023	99095	R	10,117.07
PRO ED	2986395	Pro-Ed. Inc. SCREEN ASS F/GIFT EL & MID SCH	05/04/2023	99096	R	545.60
RAYS PAINT & BODY RE	2023140	Truck repairs	05/04/2023	99097	R	2,055.20
SCHOOL HEALTH CORPOR	4192352-00	SUPPLIES	05/04/2023	99098	R	722.25
SCHOOL NURSE	0947042-IN	SUPPLIES	05/04/2023	99099	R	541.24
Schroeder Family Des	007	Inv. #007 T-Shirts BOY	05/04/2023	99100	R	397.00
SHERWIN-WILLIAMS	1722-2	SUPPLIES	05/04/2023	99101	R	164.16
SOLIANT HEALTH	Multiple	Multiple Invoices	05/04/2023	99102	R	4,008.13
Spillers, Shanna	0430	Administrative Assistant Day/Secretaries Gift	05/04/2023	99103	R	160.95
Stephenson, Jennifer	0430	TRANSPORTATION - EMPLOYEE REIMBURSEMENT FOR CDL RENEWAL	05/04/2023	99104	R	97.00
Stutts, Beau	0430	TRANSPORTATION - REIMBURSEMENT TO EMPLOYEE FOR CDL RENEWAL	05/04/2023	99105	R	105.00
SUBWAY	0503	Cookies for Academic Banquet in May	05/04/2023	99106	R	360.00
SUBWAY	0503	Cookies for Academic Banquet in May	05/11/2023	99106	V	-360.00
SUTHERLANDS BLDG. MA	Multiple	Multiple Invoices	05/04/2023	99107	R	876.10
TEACHER SYNERGY, LLC	223871000	STAAR prep for students	05/04/2023	99108	R	61.49
THE FLOWER SHOP AT 7	002890	Flowers from Junior High Staff for Funeral Services for a teachers Mother	05/04/2023	99109	R	105.00
Thomas, Maria	0427	Reimburse for Retirement Cake	05/04/2023	99110	R	100.00
Townsend, Sammie	002	Testing Coordinator for STAAR Test	05/04/2023	99111	R	4,000.00
TRACTOR SUPPLY PLAN	Multiple	Multiple Invoices	05/04/2023	99112	R	283.83
UNIFIRST CORPORATION	Multiple	Multiple Invoices	05/04/2023	99113	R	138.66
VULCAN MATERIALS COM	62609852	Base to the Bus Barn	05/04/2023	99114	R	551.37
W.F. GEORGE MIDDLE S	105	One Act Play Festival Entry Fee	05/04/2023	99115	R	150.00
WALMART CAPITAL ONE	Multiple	Multiple Invoices	05/04/2023	99117	R	925.55
WINN, KELLI	001	JUDGE	05/04/2023	99118	R	150.00
ELAN FINANCIAL SERVI	Multiple	Multiple Invoices	05/04/2023	99120	R	1,380.43
VAZQUEZ, MARTIN	0504	REFUND ON PAID RECEIPT 230427-51908-326 FOR A/C	05/04/2023	99121	R	160.00
180 SIGNS	I230425820	SIGN FOR STUDENT REGISTRATION	05/10/2023	99122	R	64.00
ACE HARDWARE OF MINE	Multiple	Multiple Invoices	05/10/2023	99125	R	1,661.64
AIRGAS USA, LLC	9996147899	MAINTENANCE-April 2023	05/10/2023	99126	R	86.33
AT&T MOBILITY	825071876X	SERVICE	05/10/2023	99127	R	1,025.80
ATTACK FIRE	Multiple	Multiple Invoices	05/10/2023	99128	R	3,277.00
AWARDS & MORE ENGRAV	44619	SUPPLIES	05/10/2023	99129	R	273.31
BAKER, FRANKLIN	0430	SECURITY 4/6,28	05/10/2023	99130	R	405.00
BARHAM, SHELBY	0430	BASEBALL GAME WORKER 4/18,26.28	05/10/2023	99131	R	150.00
BENNETT'S OFFICE SUP	Multiple	Multiple Invoices	05/10/2023	99147	R	42,107.69
Bullock, Karyn	0430	REIMBURSE SUPPLIES FOR STUDENT REGISTRATION	05/10/2023	99148	R	92.27
Burns, Rachel	0430	TRAVEL REIMBURSEMENT 4/11,18	05/10/2023	99149	R	20.00
CANDOR CONSULTING AN	1511	Inv. #1511 Contracted Services LSSP, Michael	05/10/2023	99150	R	13,741.65
CDW-G	JC88630	Smartboard for Ms. Vigil approved per Shanna Spillers	05/10/2023	99151	R	2,887.47

<u>VENDOR</u>	<u>INVOICE NUMBER</u>	<u>INVOICE DESCRIPTION</u>	<u>CHECK DATE</u>	<u>CHECK NUMBER</u>	<u>CHE TYP</u>	<u>AMOUNT</u>
CONSORTIUM FOR SCHOO	17663	CoSN annual membership	05/10/2023	99152	R	965.00
Crouch, Caleb	0430	BASEBALL GAME WORKER 4/4,18,26,28	05/10/2023	99153	R	100.00
Dearman, Andrew	0430	Mileage Mar-Apr 2023: Dearman	05/10/2023	99154	R	10.09
DEMCO, INC	7297351	Library	05/10/2023	99155	R	1,191.82
DOUBLE H TIRE	Multiple	Multiple Invoices	05/10/2023	99156	R	80.00
DUENSING, RONALD	0430	BASEBALL OFFICIAL 4/4/23	05/10/2023	99157	R	222.50
EASTMAN, JOE	0430	SOFTBALL GAME WORKER 4/4/23	05/10/2023	99158	R	25.00
ED311	Multiple	Multiple Invoices	05/10/2023	99159	R	495.00
EDUCATION SERVICE CT	Multiple	Multiple Invoices	05/10/2023	99160	R	70.00
EDWARDS, NORMAN	0430	SOFTBALL OFFICIAL 4/4/23	05/10/2023	99161	R	175.00
ELLIOTT ELECTRIC SUP	Multiple	Multiple Invoices	05/10/2023	99163	R	1,354.52
FLORES, DALE	0430	SOCCER OFFICIAL 4/6,27	05/10/2023	99164	R	150.00
FOLEY, LLOYD	0430	SECURITY 4/6,13,27	05/10/2023	99165	R	585.00
FREEZE CARPETS, INC.	0425	Statement 4 25 2023 Flooring for empty office (New HR Employee)	05/10/2023	99166	R	2,228.00
FREEZE CARPETS, INC.	0503	Statement 5 3 2023 DSC Offices Tarver and file room Mitchell	05/10/2023	99167	S	2,687.37
FRONTIER WASTE-CRESS	0430	SERVICE	05/10/2023	99168	R	7,177.59
FURR BUILDING MATERI	Multiple	Multiple Invoices	05/10/2023	99169	R	295.96
GALVAN, JOSE	0430	SOCCER OFFICIAL 4/6/23	05/10/2023	99170	R	80.00
Garrett, Deana	0430	TRANSPORTATION - CDL REIMBURSEMENT TO EMPLOYEE	05/10/2023	99171	R	97.00
GLOVER, BRANDON	0430	SECURITY 4/18/23	05/10/2023	99172	R	225.00
GOODIN, ROBERT	0430	BASEBALL OFFICIAL 4/4/23	05/10/2023	99173	R	125.00
Hamner, Valerie	0430	TRAVEL REIMBURSEMENT 4/11,18,25,27	05/10/2023	99174	R	40.00
HANSARD, Justin	0430	BASEBALL OFFICIAL 4/18/23	05/10/2023	99175	R	190.00
HIGH SCHOOL	0430	REIMB CK #12057, 12058, 12059	05/10/2023	99176	R	2,132.10
HOBART CORPORATION	29178802	MAINTENANCE-April 2023	05/10/2023	99177	R	500.15
IML SECURITY SUPPLY	3605803	MAINTENANCE-April 2023	05/10/2023	99178	R	615.84
INTERSTATE BILLING S	3032324125	TRANSPORTATION - PARTS	05/10/2023	99179	R	1,420.00
Intouch Therapy	MIN4	Inv. #MIN4 April Contracted Services PT	05/10/2023	99180	R	5,397.33
JUAN, RAMON	0518	DJ for Day at the Park for Students	05/10/2023	99181	R	300.00
KENYON, CODY	0430	BASEBALL OFFICIAL 4/28/23	05/10/2023	99182	R	190.00
La Cienega	000013	FOOD	05/10/2023	99183	R	769.45
LONE STAR COMMUNICAT	Multiple	Multiple Invoices	05/10/2023	99184	R	1,485.00
LONGHORN, INC.	Multiple	Multiple Invoices	05/10/2023	99185	R	1,064.76
MARK'S PLUMBING PART	Multiple	Multiple Invoices	05/10/2023	99186	R	1,183.60
McDaniel, Ricky	0430	TRAVEL REIMBURSEMENT 4/4,11.18.25.28	05/10/2023	99187	R	55.00
MENCHACA, CRISTAL	0430	SECURITY 4/4,19	05/10/2023	99188	R	405.00
MIKE'S WESTSIDE RENT	Multiple	Multiple Invoices	05/10/2023	99189	R	1,423.95
MINERAL WELLS ISD SP	0430	REIMBURSE PETTY CASH	05/10/2023	99190	R	20.06
MINERAL WELLS HIGH S	Multiple	Multiple Invoices	05/10/2023	99191	R	523.00
MINERAL WELLS JR. HI	0430	REIMB CK #904	05/10/2023	99192	R	279.00
NAPA AUTOMOTIVE PART	Multiple	Multiple Invoices	05/10/2023	99194	R	2,448.25
NATIONAL WHOLESALE S	Multiple	Multiple Invoices	05/10/2023	99195	R	2,826.56
O'REILLY AUTOMOTIVE,	Multiple	Multiple Invoices	05/10/2023	99196	R	42.02
PARKER, DONNA	0430	SOFTBALL GAME WORKER 4/4/23	05/10/2023	99197	R	50.00
PATTERSON, DONNA	0430	SOFTBALL OFFICIAL 4/4/23	05/10/2023	99198	R	175.00
PHILLIPS, MICHAEL	0430	BASEBALL GAME WORKER 4/4/23	05/10/2023	99199	R	50.00

<u>VENDOR</u>	<u>INVOICE NUMBER</u>	<u>INVOICE DESCRIPTION</u>	<u>CHECK DATE</u>	<u>CHECK NUMBER</u>	<u>CHE TYP</u>	<u>AMOUNT</u>
PINEN, KLARISSA	0430	SOCCER OFFICIAL 4/6,13,27	05/10/2023	99200	R	150.00
Pope, Michael	0430	TRAVEL REIMBURSEMENT 4/25/23	05/10/2023	99201	R	10.00
POSITIVE PROMOTIONS	07137582	Lanyards for Teacher Appreciation	05/10/2023	99202	R	299.95
PURVIS BEARING SERVI	Multiple	Multiple Invoices	05/10/2023	99203	R	384.89
Raspberry, Jackie	0430	Mileage Mar-Apr 2023: Raspberry	05/10/2023	99204	R	35.24
RAYS PAINT & BODY RE	2023170	Repair to Lee's pk	05/10/2023	99205	R	1,050.47
RIDDELL / ALL AMERIC	60475293	SUPPLIES	05/10/2023	99206	R	13,787.45
Ritchey, Matthew	0430	BASEBALL GAME WORKER 4/18/23	05/10/2023	99207	R	25.00
Sarah Moore Mobility	MARCH 1-MA	Inv. March 1-March 31	05/10/2023	99208	R	570.00
Shadden, Karen	0430	TRAVEL REIMBURSEMENT 4/18/23	05/10/2023	99209	R	10.00
SHERWIN-WILLIAMS	1772-7	MAINTENANCE-April 2023	05/10/2023	99210	R	44.78
SKY PIRATES INFLATAB	36592	FINAL BALANCE	05/10/2023	99211	R	1,448.85
STREUN, CHRISTY	0430	SECURITY 4/13/23	05/10/2023	99212	R	135.00
SUTHERLANDS BLDG. MA	Multiple	Multiple Invoices	05/10/2023	99214	R	2,919.07
Tarver, David	0503	End of year meal for AP's and Secretaries	05/10/2023	99215	R	104.20
TEPSA	300065326	TEPSA Membership (Mrs. Gray)	05/10/2023	99216	R	150.00
TEXAS COUNCIL OF ADM	Multiple	Multiple Invoices	05/10/2023	99217	R	165.00
TEXAS DEPT OF PUBLIC	CRS-202303	Invoice CrS-202303-259200	05/10/2023	99218	R	9.00
TEXAS WORKFORCE COMM	Multiple	Multiple Invoices	05/10/2023	99219	R	1,797.40
UNIFIRST CORPORATION	Multiple	Multiple Invoices	05/10/2023	99220	R	1,345.09
UNITED AG & TURF	1234829	MAINTENANCE-April 2023	05/10/2023	99221	R	469.18
UNITED REFRIGERATION	Multiple	Multiple Invoices	05/10/2023	99222	R	353.59
WALMART CAPITAL ONE	Multiple	Multiple Invoices	05/10/2023	99228	R	5,963.30
WATSON, Cooper	0430	BASEBALL OFFICIAL 4/28/23	05/10/2023	99229	R	190.00
WEX BANK	88746815	FUEL	05/10/2023	99230	R	901.54
WHALEY FOODSERVICE	Multiple	Multiple Invoices	05/10/2023	99231	R	93.02
WILLIAMS, ANTHONY	0430	SOCCER OFFICIAL 4/6,13,27	05/10/2023	99232	R	415.00
SUBWAY	0503	Cookies for Academic Banquet in May	05/11/2023	99233	R	314.86
ABM TEXAS GENERAL SE	Multiple	Multiple Invoices	05/17/2023	99234	R	86,397.58
AMPLIFY SECURE DOCUM	523053	Amplify Shred Bin	05/17/2023	99235	R	50.00
B & H PHOTO	212724351	Wireless Microphone	05/17/2023	99236	R	318.39
BAILEY, JONATHAN	0430	BASEBALL OFFICIAL 4/18/23	05/17/2023	99237	R	190.00
BENNETT'S OFFICE SUP	Multiple	Multiple Invoices	05/17/2023	99238	R	3,599.05
BRANDON'S KITCHEN	0001		05/17/2023	99239	R	600.00
BSN SPORTS, LLC	921521691	SUPPLIES	05/17/2023	99240	R	2,361.45
CAR COLORS	73163	Supplies Wraight	05/17/2023	99241	R	365.85
CITY WATER WORKS	0430	SERVICE	05/17/2023	99242	R	8,854.81
CROSS PLAINS OIL FIE	Multiple	Multiple Invoices	05/17/2023	99243	R	506.05
DISA GLOBAL SOLUTION	Multiple	Multiple Invoices	05/17/2023	99244	R	2,320.50
DATA RECOGNITION COR	168669	DRC/LAS Links PreLas Form C, Scannable Score Sheet	05/17/2023	99245	R	700.00
ED311	26819	ED 311 for A.P. Maycan Tomlin, training	05/17/2023	99246	R	199.00
EDUCATION SERVICE CT	1002301055	TRANSPORTATION - 20 HOUR BUS DRIVER CERTIFICATION COURSES AND 8 HOUR ONLINE/CLASS RECERTIFICATION COURSES. THIS IS TO INCLUDE WALK IN FEES, CERTIFCATION CARD DUPLICATE REQUEST FEES. ***** OPEN PURCHASE ORDER FOR THE 2022-2023 SCHOOL	05/17/2023	99247	R	140.00

<u>VENDOR</u>	<u>INVOICE NUMBER</u>	<u>INVOICE DESCRIPTION</u>	<u>CHECK DATE</u>	<u>CHECK NUMBER</u>	<u>CHE TYP</u>	<u>AMOUNT</u>
		YEAR***** CLOSE PURCHASE ORDER AT THE END OF AUGUST 2023				
EDUCATION SERVICE CT	013097	Community Health Worker Certification	05/17/2023	99248	R	350.00
FAMOUS MINERAL WATER	B3985	Inv. #B3985 Crazy Water	05/17/2023	99249	R	43.75
FREEZE CARPETS, INC.	0425	FREEZE CARPETS FLOORING KENZIE KING	05/17/2023	99250	R	1,966.75
FURR BUILDING MATERI	25218	MAINTENANCE-April 2023	05/17/2023	99251	R	95.92
GOTO COMMUNICATIONS,	IN71019237	SERVICE	05/17/2023	99252	R	4,859.26
HIGH SCHOOL	0517	REIMB CK #12060,12061	05/17/2023	99253	R	739.35
JONES SCHOOL SUPPLY	1962480	awards	05/17/2023	99254	R	686.12
KYOCERA DOCUMENT SOL	Multiple	Multiple Invoices	05/17/2023	99255	R	1,851.01
LEASOR CRASS, P.C.	19537	LEGAL FEES	05/17/2023	99256	R	4,064.00
LIBRARYTRAC LLC	3541	Library trac subscription	05/17/2023	99257	R	275.00
LOWMAN CONSULTING LL	4440	software program	05/17/2023	99258	R	500.00
MINERAL WELLS HIGH S	2023-1	INV. 2023-1 MEMORIAL STUDENT BENCH	05/17/2023	99259	R	100.00
NAPA AUTOMOTIVE PART	Multiple	Multiple Invoices	05/17/2023	99261	R	2,350.75
NASCO	431933	Art Supplies for Bernet	05/17/2023	99262	R	931.25
NAVIGATE360, LLC	Multiple	Multiple Invoices	05/17/2023	99263	R	10,660.00
NEEDEDECALS	10513	QUOTE GIANT HANG TAGS	05/17/2023	99264	R	2,400.00
OVERDRIVE, INC.	10264CO231	SUPPLIES	05/17/2023	99265	R	667.10
RANDY'S SERVICE CENT	103915	MAINTENANCE-December 2022	05/17/2023	99266	R	7.00
RR SERVICE CO, INC.	4595	MAINTENANCE-April 2023	05/17/2023	99267	R	435.00
SALT CREEK SHOOTING	1495	SCHOOL SAFETY CERTIFICATION	05/17/2023	99268	R	1,200.00
SCHOOL HEALTH CORPOR	4194565-00	School Nurse Supplies	05/17/2023	99269	R	514.65
SCHOOL TECHNOLOGY AS	INV-9958	QUOTE #00011431 - TRANSCRIPTS	05/17/2023	99270	R	204.00
Spillers, Shanna	0511	TRAVEL	05/17/2023	99271	R	158.57
Stutts, Laura	0430	State Travel Reimbursement	05/17/2023	99272	R	448.80
TASB	Multiple	Multiple Invoices	05/17/2023	99273	R	1,940.00
TEXAS ACCESSIBILITY	2019010071	Inspection of JH gym floor-2023	05/17/2023	99274	R	500.00
TEXAS DEPT OF PUBLIC	CRS-202304	Invoice CRS-202304-261193 Background checks	05/17/2023	99275	R	5.00
THE CERTIFIED WELDIN	435-42823	Student Certification Exam Fee	05/17/2023	99276	R	720.00
THE CRAZY WATER HOTE	0522	CONFERENCE ROOM RENTAL FOR APPLE CORPS LUNCHEON	05/17/2023	99277	R	175.00
Torres, Rocky	0517	Student Travel Reimbursement	05/17/2023	99278	R	436.19
Unerfusser, Jason	0517	reimbursement for fuel	05/17/2023	99279	R	20.00
WALMART CAPITAL ONE	Multiple	Multiple Invoices	05/17/2023	99280	R	371.08
AGiRepair, Inc.	071954	Device Repairs	05/23/2023	99281	R	99.00
AT&T LONG DISTANCE	811340500	SERVICE-CORPORATION #346970 811340500-0	05/23/2023	99282	R	35.97
CDW-G	Multiple	Multiple Invoices	05/23/2023	99283	R	3,863.27
EAGLE SOUND, INC.	17501	TRANSPORTATION - SUPPLY	05/23/2023	99284	R	169.95
EDUCATION SERVICE CT	4102300525	Monthly Internet Service May 2023	05/23/2023	99285	R	1,000.00
ENVIROMATIC SERVICES	SV25421	MAINTENANCE-May 2023	05/23/2023	99286	R	440.00
Everything Shredded	Multiple	Multiple Invoices	05/23/2023	99287	R	210.00
FAMOUS MINERAL WATER	Multiple	Multiple Invoices	05/23/2023	99288	R	70.00
FOLLETT CONTENT SOLU	Multiple	Multiple Invoices	05/23/2023	99289	R	2,055.69
HOME DEPOT CREDIT SE	Multiple	Multiple Invoices	05/23/2023	99290	R	994.79
JODIE'S ALTERNATOR	707	TRANSPORTATION - PARTS	05/23/2023	99291	R	125.00
KYOCERA DOCUMENT SOL	Multiple	Multiple Invoices	05/23/2023	99292	R	722.20

VENDOR	INVOICE	INVOICE	CHECK	CHECK CHE		AMOUNT
	NUMBER	DESCRIPTION	DATE	NUMBER	TYP	
MINERAL WELLS JR. HI	0509	REIMBURSE PETTY CASH	05/23/2023	99293	R	10.45
MUSIC IS ELEMENTARY	INV-26767	Music	05/23/2023	99294	R	955.80
NAVIGATE360, LLC	Multiple	Multiple Invoices	05/23/2023	99295	R	230.00
PRECISION BUSINESS M	114105	Postage Maker	05/23/2023	99296	R	1,678.21
RECORDS CONSULTANTS,	48394	Records Retention Update Proposal	05/23/2023	99297	R	15,560.00
ROCHESTER 100, INC.	INV049644	Responsibility Folders for students	05/23/2023	99298	R	685.25
Rothe, Michaela	0430	April Mileage	05/23/2023	99299	R	77.36
SCHOOL NURSE	0946276-IN	Nurse	05/23/2023	99300	R	2,009.00
SHELL ENERGY SOLUTIO	1897991	SERVICE	05/23/2023	99301	R	42,122.02
SPRINGHILL SUITES BY	0528	TRAVEL	05/23/2023	99302	S	516.88
TEPSA	Multiple	Multiple Invoices	05/23/2023	99303	R	818.00
TEXAS GAS SERVICES	0511	SERVICE	05/23/2023	99304	R	4,066.19
UNITE PRIVATE NETWOR	SI-23-0150	Monthly WAN service due 06/01/2023	05/23/2023	99305	R	754.11
WALMART CAPITAL ONE	07675	PEIMS MEETING	05/23/2023	99306	R	165.86
WEISSMANS DESIGNS	Multiple	Multiple Invoices	05/23/2023	99307	R	4,272.03
KYOCERA DOCUMENT SOL	Multiple	Multiple Invoices	05/24/2023	99308	R	714.10
GRAHAM, TERRY	0430	Inv. 1 Contracted Services SLPA 4-11, 4-12, 4-17, 4-24	05/04/2023	222300069	A	3,100.00
Nazifpour, Shayda	04/19/2023	Contracted Services 4-19-4-20 SLPA	05/04/2023	222300070	A	525.00
ONCOR ELECTRIC DELIV	21389560	Install of facilities for the new Scoreboard	05/04/2023	222300071	A	11,280.59
AMAZON CAPITAL SERVI	Multiple	Multiple Invoices	05/04/2023	222300072	A	1,350.17
AMAZON CAPITAL SERVI	Multiple	Multiple Invoices	05/10/2023	222300073	A	952.71
Bricker, Niki	0430	Mileage Mar-Apr 2023: Bricker	05/10/2023	222300074	A	78.80
Cotton, Mark II	0430	Mileage Mar-Apr 2023: Cotton	05/10/2023	222300075	A	82.79
Johnson, Austin	0430	Mileage Mar-Apr 2023: Johnson	05/10/2023	222300076	A	161.98
Murphy, Ronda	0430	Mileage Mar-Apr 2023: Murphy	05/10/2023	222300077	A	82.79
Nazifpour, Shayda	04/24/2023	Contracted Services4-24, 4-25, 4-26, 4-27 SLPA	05/10/2023	222300078	A	1,025.00
AMAZON CAPITAL SERVI	Multiple	Multiple Invoices	05/17/2023	222300080	A	5,949.68
CUMMINS SOUTHERN PLA	84-50943	TRANSPORTATION - PARTS	05/17/2023	222300081	A	192.61
Hall, Kay	0508	FOOD FOR SCHOOL BOARD MEALS	05/17/2023	222300082	A	86.43
KONE INC.	Multiple	Multiple Invoices	05/17/2023	222300083	A	2,739.81
AMAZON CAPITAL SERVI	Multiple	Multiple Invoices	05/23/2023	222300085	A	2,213.91
Hall, Kay	0522	FOOD FOR INTERVIEW COMMITTEE	05/23/2023	222300086	A	40.66
Totals for checks						471,109.54

FUND SUMMARY

<u>FUND</u>	<u>DESCRIPTION</u>	<u>BALANCE SHEET</u>	<u>REVENUE</u>	<u>EXPENSE</u>	<u>TOTAL</u>
180	CO-CURRICULAR	0.00	0.00	42,004.15	42,004.15
199	GENERAL FUND	0.00	160.00	428,945.39	429,105.39
***	Fund Summary Totals ***	0.00	160.00	470,949.54	471,109.54

***** End of report *****

<u>VENDOR</u>	<u>INVOICE NUMBER</u>	<u>INVOICE DESCRIPTION</u>	<u>CHECK DATE</u>	<u>CHECK NUMBER</u>	<u>CHE TYP</u>	<u>AMOUNT</u>
Christenson, Brenda	0430	FOOD HANDLERS CARD REIMBURSEMENT	05/10/2023	6300	R	7.99
FORTE DFW LLC	Multiple	Multiple Invoices	05/10/2023	6301	R	1,753.47
Fowler, Tammy	0430	EMPLOYEE IN DISTRICT TRAVEL REIMBURSEMENT	05/10/2023	6302	R	15.72
KLEMENT DISTRIBUTION	10313835	ICE CREAM	05/10/2023	6303	R	221.72
LABATT FOOD SERVICE	0430	APRIL GROCERIES	05/10/2023	6304	R	83,219.41
PATINO, PAMELA	0430	EMPLOYEE IN DISTRICT TRAVEL REIMBURSEMENT	05/10/2023	6305	R	17.82
Wells, David	0430	EMPLOYEE IN DISTRICT TRAVEL REIMBURSEMENT	05/10/2023	6306	R	107.49
FORTE DFW LLC	14647	Storage fees April	05/17/2023	6307	R	118.75
HILAND DAIRY FOODS C	0430	April Milk	05/17/2023	6308	R	18,434.77
BENNETT'S OFFICE SUP	0251988-00	Office supplies	05/23/2023	6309	R	44.91
FORTE DFW LLC	14767	Commodities delivery and storage	05/23/2023	6310	R	1,388.60
MASSEY'S SEPTIC TANK	46295	Grease Trap pumping	05/23/2023	6311	R	660.00
Totals for checks						105,990.65

FUND SUMMARY

<u>FUND</u>	<u>DESCRIPTION</u>	<u>BALANCE SHEET</u>	<u>REVENUE</u>	<u>EXPENSE</u>	<u>TOTAL</u>
240	FOOD SERVICE	0.00	0.00	105,990.65	105,990.65
***	Fund Summary Totals ***	0.00	0.00	105,990.65	105,990.65

***** End of report *****

<u>VENDOR</u>	<u>INVOICE NUMBER</u>	<u>INVOICE DESCRIPTION</u>	<u>CHECK DATE</u>	<u>CHECK CHE NUMBER TYP</u>	<u>AMOUNT</u>
ROSETTA STONE LTD	11695921	LOST IN MAIL - STOP PAYMENT ISSUED 5/3/2023	05/03/2023	19531 R	302.50
ROSETTA STONE LTD	11600920	LOST IN MAIL - STOP PAYMENT ISSUED 5/3/2023	05/03/2023	19531 R	1,650.00
AUSTIN AQUARIUM LLC	0511	Cadets Austin Trip	05/04/2023	19532 R	416.60
BOUNCING STARS PARTY	8979	Bounce House for Field Day	05/04/2023	19533 R	599.48
ELAN FINANCIAL SERVI	0430-6	Zoo Field Trip for 2nd Grade	05/04/2023	19534 R	1,862.00
ELAN FINANCIAL SERVI	0430-6	Zoo Field Trip for 2nd Grade	05/04/2023	19534 V	-1,862.00
FAMOUS MINERAL WATER	B3938	INV. B3938 6 JUGS OF WATER	05/04/2023	19535 R	46.50
FOOD SERVICE	121	Popsicles for Field Day	05/04/2023	19536 R	420.00
HARGROVE SERVICES, L	STAARSHIRT	TNT - STAAR Shirts	05/04/2023	19537 R	600.00
HARGROVE SERVICES, L	BOB2023	Library	05/04/2023	19537 R	1,176.00
IMAGINE LEARNING, IN	930531	IL Imagine Learning Mineral Wells High School Digital Libraries 6-12 Comprehensive All Site License (MS and HS content for math, ELA science, social studies, electives, AP, word languages, Virtual Tutors. excludes eDynamic Learning and Purpose Prep) Digital Libraries Enhanced CTE Add-on Site License Mineral Wells ISD EdgeEX Promotional Access-Available Fall 2023 access not to exceed 6/30/2024 Professional Development Webinar Training	05/04/2023	19539 R	26,450.00
MOTE TECHNOLOGIES, I	12100	Mote Technologies Bilingual Department Travis Elementary Online Program For Students	05/04/2023	19540 R	540.00
SUTHERLANDS BLDG. MA	47232	Tools/Equipment	05/04/2023	19541 R	24.92
SUTHERLANDS BLDG. MA	47359	Tools/Equipment	05/04/2023	19541 R	898.98
TEXO ABC, AGC INC.	INV-000431	NCCER Sponsorship, student subscription, teacher training.	05/04/2023	19542 R	2,845.00
ELAN FINANCIAL SERVI	0430-6	Zoo Field Trip for 2nd Grade	05/04/2023	19543 R	1,862.00
ACE HARDWARE OF MINE	311075	Tools Construction	05/10/2023	19544 R	96.98
BENNETT'S OFFICE SUP	0251488-00	Tools Construction Shop	05/10/2023	19545 R	426.74
BENNETT'S OFFICE SUP	0251622-00	Cadets	05/10/2023	19545 R	39.94
ESTRELLITA	R27303	Estrellita Accelerated Beginning Spanish Reading Lamar	05/10/2023	19546 R	2,632.44
IMCAT	4137	IMCAT Instructional Materials Coordinator Association of Texas	05/10/2023	19547 R	115.00
MEDICAID CLAIM SOLUT	23-182903-	Inv. #23-182903-009 Services Rendered	05/10/2023	19548 R	175.98
MEDICAID CLAIM SOLUT	23-182903-	Inv. #23-182903-010 Services Rendered	05/10/2023	19548 R	4,903.41
TEX-OMA BUILDERS SUP	793870	Security Grant-April 2023	05/10/2023	19549 R	13,809.00
TEX-OMA BUILDERS SUP	793873	Security Grant-April 2023	05/10/2023	19549 R	849.00
THE COLLEGE BOARD	ES186078	COLLEGE BOARD MWHS SAT STUDENT TESTING 2023	05/10/2023	19550 R	962.00
WALMART CAPITAL ONE	00559	Water for Zoo field trip	05/10/2023	19551 R	55.19

<u>VENDOR</u>	<u>INVOICE NUMBER</u>	<u>INVOICE DESCRIPTION</u>	<u>CHECK DATE</u>	<u>CHECK NUMBER</u>	<u>CHE TYP</u>	<u>AMOUNT</u>
WALMART CAPITAL ONE	05167	STUCO	05/10/2023	19551	R	396.15
ALLSTAR CUSTOM APPAR	1424	Field Day tshirts	05/17/2023	19552	R	2,720.62
BARKER, CAEDEN	0517	CAEDEN BARKER PHOTOGRAPY/VIDEOGRAPHY MULTICULTURAL EVENT	05/17/2023	19553	R	400.00
LEAD 4 WARD, LLC	3TTAL25076	Induction Training -of Trainers-hosted by Aledo ISD lead4ward Angie Myrick	05/17/2023	19554	R	575.00
Lewallen, Jonathan	459	Jonathan Lewallen/JJ The Clown-Multi Cultural Night 2023	05/17/2023	19555	R	200.00
MEDLIN, GINA	0518	JUMPIN FOR JOY BOUNCE HOUSE RENTALS GINA MEDLIN	05/17/2023	19556	R	655.00
Mendez-Vergara, Ruth	0430	April Contracted Service	05/17/2023	19557	R	450.00
MHS MULTI-HEALTH SYS	ORD-306594	ASR023 ASRS 2-5 Year parent ASR024 ASRS 2-5 years teacher CD2010 CDI-2 Teacher forms	05/17/2023	19558	R	148.50
SALAZAR, KENNY	0518	K & A DJ Services Multi Cultural Night -MWHS Stadium	05/17/2023	19559	R	300.00
SIGN GYPSIES 76067	000266	#000266 for walk of honor 22-23	05/17/2023	19560	S	50.00
SIGN GYPSIES 76067	000267	SIGN GYPSIES MULTICULTURAL EVENT 2023	05/17/2023	19561	S	100.00
SOLIANT HEALTH	20671593	Inv. #20671593 Contracted Services 4-30-23 Mary	05/17/2023	19562	R	2,020.75
SOLIANT HEALTH	20676221	Inv. #20676221 Contracted Services Mary SLPA	05/17/2023	19562	R	2,055.00
WALMART CAPITAL ONE	06218	STUCO	05/17/2023	19563	R	68.40
WALMART CAPITAL ONE	07305	STUCO (STAAR Appreciation for Teachers)	05/17/2023	19563	R	169.55
ALLSTAR CUSTOM APPAR	1439	Allstar Custom Apparel	05/23/2023	19564	R	174.75
CRISIS PREVENTION IN	CUS033416	PBLN20NCI Nonviolent Crisis Intervention 2nd ED Blended Learning Pkg. (Online Course & Workbook)	05/23/2023	19565	R	2,891.85
ENVIROMATIC SERVICES	SSV24532	HVAC Equipment and DDC Controls Replacement	05/23/2023	19566	R	90,917.00
ENVIROMATIC SERVICES	SV24886	HVAC Equipment and DDC Controls Replacement	05/23/2023	19566	R	64,481.78
ENVIROMATIC SERVICES	SV25570	HVAC Equipment and DDC Controls Replacement	05/23/2023	19566	R	74,952.10
GENERATION GENIUS, I	GG177872-R	Generation Genius School License-Travis	05/23/2023	19567	R	995.00
IMAGINATION STATION	SIN024338	ISTATION SPANISH - HOUSTON ELEMENTARY - LAMAR ELEMENTARY - TRAVIS ELEMENTARY & PD FOR TEACHERS	05/23/2023	19568	R	7,924.00
IML SECURITY SUPPLY	3607094	Security Grant-April 2023	05/23/2023	19569	R	307.66
IML SECURITY SUPPLY	3582660	Security Grant-April 2023	05/23/2023	19569	R	269.50
IML SECURITY SUPPLY	3610451	Security Grant-April 2023	05/23/2023	19569	R	612.60
Maldonado, Esmeralda	0523	Reimbursement Multicultural Night 2023-Maracas / Esmeralda Maldonado Travis Elementary Teacher	05/23/2023	19570	R	52.99
MEDLIN, GINA	0519	Cadets Extreme Day Fundraiser	05/23/2023	19571	R	2,666.25
ORIENTAL TRADING COM	7243604480	StuCO	05/23/2023	19572	R	52.81

<u>VENDOR</u>	<u>INVOICE NUMBER</u>	<u>INVOICE DESCRIPTION</u>	<u>CHECK DATE</u>	<u>CHECK NUMBER</u>	<u>CHE TYP</u>	<u>AMOUNT</u>
ORIENTAL TRADING COM	7243604480	StuCO	05/23/2023	19572	R	412.00
SOLIANT HEALTH	20684361	Inv. #20684361 Contracted Services 5-14-23 SLPA	05/23/2023	19573	R	2,037.88
SUTHERLANDS BLDG. MA	47629	Equipment	05/23/2023	19574	R	899.97
The Science Penguin,	02-1453	THE SCIENCE PENGUIN 3RD & 5TH GRADE LICENSE HOUSTON/TRAVIS ELEMENTARY	05/23/2023	19575	R	999.00
WALMART CAPITAL ONE	07980	STUCO (Cupcakes for a pet's sake fundraiser)	05/23/2023	19576	R	120.10
WESTERN PSYCHOLOGICA	WPS-458075	W-608AP25 SRS-2 School-Age Online Form (25 use) ATTN: Michael Murphy mmurphy2@mwisd.net	05/23/2023	19577	R	71.00
WestWorks Learning C	1172	Inv. #1172 April Contracted services Speech	05/23/2023	19578	R	8,175.00
Nazifpour, Shayda	5/1/2023-5	Inv. 5-1 - 5-4 Contracted Services SLPA	05/17/2023	222300084	A	975.00
AMAZON CAPITAL SERVI	1LN4-7R6G-	Face Paint	05/23/2023	222300087	A	79.96
Nazifpour, Shayda	5/8/2023-5	Inv. 5-8-23-5-10-23 Contracted Services SLPA	05/23/2023	222300088	A	625.00
Nazifpour, Shayda	5/16/2023-	Inv. 5-16 - 5-17 Contracted Services SLPA	05/23/2023	222300088	A	525.00
Totals for checks						333,424.83

FUND SUMMARY

<u>FUND</u>	<u>DESCRIPTION</u>	<u>BALANCE SHEET</u>	<u>REVENUE</u>	<u>EXPENSE</u>	<u>TOTAL</u>
211	TITLE I, PART A	0.00	0.00	2,994.00	2,994.00
225	IDEA-B PRESCHOOL	0.00	0.00	975.00	975.00
244	CARL PERKINS BASIC FORM. GRANT	0.00	0.00	5,192.59	5,192.59
255	TITLE II, PART A-SUP EFF INSTR	0.00	0.00	575.00	575.00
263	Title III, PART A-ELA	0.00	0.00	12,059.14	12,059.14
281	ESSER II PPRP	0.00	0.00	230,350.88	230,350.88
282	ESSER III	0.00	0.00	1,952.50	1,952.50
284	IDEA-B FORMULA-ARP	0.00	0.00	18,999.98	18,999.98
289	FEDERALLY FUNDED SPECIAL REV	0.00	0.00	962.00	962.00
410	STATE TEXTBOOK FUND	0.00	0.00	26,565.00	26,565.00
429	STATE FUNDED SPECIAL REVENUE	0.00	0.00	15,847.76	15,847.76
455	SHARS-MEDICAID	0.00	0.00	5,079.39	5,079.39
461	CAMPUS ACTIVITY FUND	0.00	0.00	11,871.59	11,871.59
***	Fund Summary Totals ***	0.00	0.00	333,424.83	333,424.83

***** End of report *****



BOARD OF TRUSTEES Agenda Item

MEETING DATE: 6/12/23

MEETING TYPE:

- Regular Meeting
- Special Meeting

AGENDA ITEM TYPE:

- Action Item
- Non-Action Item

BOARD GOALS (check all that apply)

Academic Goals

- Academic Competitiveness
 - Early Literacy (HB3)
 - Early Math (HB3)
 - Other
- Career Certifications (HB3)

Operational Goals

- Promote Community/School Partnerships
- Fiscal Responsibility
- Safe and Secure Schools

TITLE: Discuss, Consider, and Take Any Necessary Action Regarding the Water/Electricity/Gas Reports

RECOMMENDED ACTION: It is recommended that the Water/Electricity/Gas Reports be approved as presented.

BOARD POLICY/STATE REGULATION/LAW REFERENCE (if applicable):

OVERVIEW:

See attached utility reports.

FISCAL IMPACT: Variable Cost to District

ATTACHMENTS: Water/Electricity/Gas Reports

DEPARTMENT(S) SUBMITTING FORM: Business and Finance

DEPARTMENT SIGNATURE/APPROVAL:  

Water

2015-2016	Sep	Oct	Nov	Dec	Jan	Feb	Mar	Apr	May	Jun	Jul	Aug	Total
High School	2,756.59	2,569.46	2,063.89	2,060.25	2,039.80	1,774.43	1,654.41	2,041.42	1,740.43	1,027.42	786.43	1,492.43	21,996.96
Junior High	1,189.08	1,232.27	1,716.51	1,154.41	802.60	742.60	761.30	774.65	893.27	1,129.25	794.57	791.09	11,781.60
Travis	1,245.64	2,276.77	1,804.49	1,689.91	1,742.52	1,304.50	1,493.51	1,516.52	1,410.50	895.51	580.52	1,174.26	17,044.65
Houston	2,348.96	2,947.27	1,618.26	1,399.30	1,059.91	1,318.92	1,472.92	1,542.92	1,442.90	632.90	628.35	1,091.91	17,598.92
Lamar	1,288.38	3,677.70	853.20	869.74	642.51	813.78	745.60	836.34	836.51	1,411.76	6,501.16	797.37	19,294.05
DSC	792.01	742.70	792.87	845.07	573.10	851.54	711.10	687.54	735.10	766.09	752.27	978.96	9,228.35
Athletics	4,499.97	6,724.55	1,804.00	1,477.44	981.19	1,242.67	1,077.14	1,282.62	1,034.73	2,843.80	3,447.24	2,789.21	29,106.51
Transportation	147.86	119.86	107.13	113.50	89.92	205.90	81.90	92.91	82.91	115.90	68.91	101.90	1,328.60
Total	14,168.44	20,292.58	10,750.35	9,409.62	7,951.95	8,254.34	7,997.88	8,774.92	7,976.35	8,732.63	13,559.45	9,218.13	127,287.24

2016-2017	Sep	Oct	Nov	Dec	Jan	Feb	Mar	Apr	May	Jun	Jul	Aug	Total
High School	1,877.42	1,777.42	1,698.70	2,135.78	1,943.91	1,765.39	1,674.40	1,722.63	1,788.27	1,064.37	1,872.41	1,460.98	20,785.68
Junior High	2,050.48	2,860.17	900.61	1,011.92	818.24	790.29	723.68	775.94	834.74	411.48	418.81	713.62	12,309.98
Travis	1,824.52	1,688.50	1,637.84	1,511.64	1,998.99	1,711.70	1,534.53	1,776.66	1,550.94	741.43	418.81	713.62	12,309.98
Houston	1,610.97	1,643.91	1,893.61	1,094.36	1,558.11	1,481.16	1,530.73	1,717.46	1,702.06	559.10	548.84	1,244.47	16,584.93
Lamar	1,511.84	938.82	889.93	701.45	998.88	988.73	884.41	984.86	945.88	371.53	317.14	816.75	10,350.22
DSC	718.88	769.10	791.64	780.36	776.25	770.10	770.99	788.43	798.69	741.23	695.07	770.99	9,211.71
Athletics	2,903.21	2,180.50	1,555.99	1,027.56	1,730.00	951.04	1,344.57	1,160.79	1,205.79	2,056.10	1,488.66	1,885.77	19,499.98
Transportation	89.92	97.90	127.61	87.60	99.91	107.10	95.67	95.67	93.62	97.72	77.20	103.88	1,171.80
Total	17,877.19	17,956.32	9,495.93	8,350.67	9,824.29	8,565.51	8,558.98	9,022.44	8,919.99	6,056.96	5,996.43	7,428.04	106,602.75

2017-2018	Sep	Oct	Nov	Dec	Jan	Feb	Mar	Apr	May	Jun	Jul	Aug	Total
High School	1,793.41	2,002.35	2,077.96	1,352.11	2,261.64	1,630.65	4,459.94	1,791.19	1,604.87	1,052.63	980.76	1,475.33	22,982.94
Junior High	894.63	1,124.27	823.31	667.31	825.28	982.72	482.65	759.68	574.70	285.66	429.75	756.47	6,572.43
Travis	2,956.57	1,769.29	2,275.21	1,914.24	2,791.32	2,879.13	2,052.84	2,209.42	1,726.97	609.72	452.08	458.42	22,075.21
Houston	1,725.66	2,328.61	1,891.37	1,746.70	2,122.29	2,861.84	1,213.47	1,776.32	1,488.54	879.84	841.05	1,409.21	20,284.90
Lamar	992.25	1,041.73	908.49	755.02	942.28	942.28	885.15	1,018.46	984.60	630.18	460.89	891.49	10,452.76
DSC	746.37	798.89	831.23	814.75	814.86	796.77	844.23	798.89	845.44	831.04	828.51	809.47	9,780.45
Athletics	2,601.71	2,375.07	1,532.22	1,934.58	1,312.88	1,348.02	1,375.72	1,374.17	1,348.06	2,033.00	1,671.53	2,920.34	21,767.28
Transportation	107.99	120.25	113.03	109.67	113.91	114.96	118.14	120.25	117.84	116.03	459.87	111.79	1,718.73
Total	11,818.59	11,560.46	10,452.76	9,284.36	11,704.46	11,556.37	11,432.14	9,798.38	8,686.12	6,518.10	6,115.44	8,632.52	117,759.70

2018-2019	Sep	Oct	Nov	Dec	Jan	Feb	Mar	Apr	May	Jun	Jul	Aug	Total
High School	2,035.85	1,841.10	1,632.61	1,576.98	1,745.54	2,020.36	1,685.36	2,035.33	1,640.82	915.49	712.22	1,391.03	19,233.49
Junior High	1,852.81	1,636.34	1,119.09	1,098.72	1,319.49	1,168.03	1,268.32	1,243.90	1,069.90	757.09	744.00	1,281.05	15,149.74
Travis	3,238.70	2,257.94	2,068.61	1,886.65	1,992.11	1,912.15	1,479.83	2,002.55	1,544.75	825.01	1,073.19	1,609.64	21,841.13
Houston	1,805.94	1,777.39	1,613.69	1,627.97	1,861.73	1,813.47	1,434.05	1,794.50	1,502.44	847.60	897.43	1,606.73	18,437.27
Lamar	1,173.98	1,230.01	1,101.44	1,033.90	1,103.44	1,239.05	1,051.29	1,339.88	1,083.74	574.93	600.43	1,244.83	12,778.96
DSC	850.72	874.00	905.70	944.04	979.97	964.70	999.67	1,034.44	1,002.44	941.67	802.85	768.63	11,068.92
Athletics	2,097.28	1,914.95	1,798.22	1,472.44	1,437.23	1,436.02	1,491.29	1,447.04	1,331.90	1,341.56	3,990.43	2,100.99	20,616.05
Transportation	126.60	135.05	139.64	150.08	165.13	160.50	205.71	186.00	163.97	162.87	167.45	184.85	1,947.80
Total	13,181.89	11,666.82	10,381.09	9,785.78	10,604.64	11,173.41	9,551.86	11,127.89	9,450.10	6,356.51	6,280.13	11,978.19	121,536.30

2019-2020	Sep	Oct	Nov	Dec	Jan	Feb	Mar	Apr	May	Jun	Jul	Aug	Total
High School	1,966.40	2,147.15	1,730.77	1,513.98	1,707.02	1,872.76	885.08	702.67	1,037.72	629.04	613.02	1,271.69	16,077.30
Junior High	1,603.39	2,624.26	1,027.81	819.54	943.91	1,121.78	650.49	502.94	471.09	826.08	627.80	1,096.43	12,315.52
Travis	1,668.76	2,786.04	1,648.91	1,948.28	1,637.02	1,892.45	1,205.79	845.82	603.47	924.23	675.94	1,514.66	17,351.37
Houston	2,010.06	2,197.81	2,746.41	1,651.03	2,145.23	2,151.17	2,136.91	476.19	1,002.37	1,112.86	1,319.57	1,552.42	19,979.00
Lamar	1,692.21	1,527.63	1,580.20	1,007.58	1,157.27	1,241.62	670.40	419.52	420.71	443.28	487.24	887.24	11,428.13
DSC	821.40	853.85	833.39	833.99	833.99	540.56	381.37	359.27	358.79	338.60	350.48	489.47	6,837.27
Athletics	2,409.03	2,148.83	1,689.16	1,531.17	1,493.16	1,534.38	1,398.14	1,357.39	1,411.05	1,397.93	1,481.61	2,762.80	20,616.05
Transportation	209.18	216.13	211.19	229.02	218.34	232.58	211.21	210.01	213.58	219.52	236.15	265.84	2,672.75
Total	12,387.39	14,501.71	10,987.84	9,534.59	9,977.95	10,587.30	7,439.39	6,823.91	5,518.78	5,890.94	5,791.81	9,833.78	107,275.39

2020-2021	Sep	Oct	Nov	Dec	Jan	Feb	Mar	Apr	May	Jun	Jul	Aug	Total
High School	1,706.46	1,733.80	1,646.64	1,322.04	1,464.25	1,445.60	1,687.31	1,857.03	2,196.34	1,093.67	958.10	1,889.35	18,800.59
Junior High	1,038.88	947.49	883.72	796.12	1,287.90	981.24	964.53	1,024.66	972.29	646.54	510.89	954.35	12,008.61
Travis	2,010.06	2,228.48	1,994.25	1,491.09	1,776.98	1,613.99	2,390.21	2,458.34	2,276.65	927.28	749.60	1,913.26	21,830.69
Houston	1,197.67	1,291.51	1,427.16	912.80	1,098.51	1,042.71	1,241.45	1,421.34	1,381.73	387.07	357.69	381.04	9,498.54
Lamar	1,354.56	1,398.17	1,308.57	1,463.49	1,282.31	1,436.75	1,173.91	1,151.10	1,051.10	797.37	624.47	747.47	12,349.90
DSC	423.98	433.83	527.38	533.80	349.65	346.68	282.83	312.53	312.53	312.53	312.53	312.53	3,210.68
Athletics	1,845.97	1,733.82	2,193.89	1,797.03	1,899.54	2,526.83	1,970.25	1,785.48	1,934.81	2,621.30	2,421.77	2,421.77	24,216.77
Transportation	261.09	281.29	254.47	245.10	245.12	242.44	261.14	263.81	261.14	326.61	162.28	246.46	3,050.95
Total	10,628.86	9,300.75	10,345.13	8,989.60	10,551.11	11,091.56	10,800.21	10,041.94	9,951.61	6,283.33	5,630.54	9,568.95	113,183.19

2021-2022	Sep	Oct	Nov	Dec	Jan	Feb	Mar	Apr	May	Jun	Jul	Aug	Total
High School	2,339.79	2,493.16	2,228.00	2,181.86	2,794.16	2,386.10	2,609.90	2,857.49	3,671.42	1,764.86	1,785.27	2,087.82	29,199.83
Junior High	1,571.80	1,590.57	1,613.19	1,861.45	2,121.11	1,620.86	1,222.66	1,241.69	1,302.94	655.54	625.70	1,439.27	16,866.78
Travis	2,963.35	2,698.82	2,756.45	3,703.37	3,441.66	1,879.39	1,678.94	1,769.01	387.32	366.22	370.44	374.66	22,339.63
Houston	1,619.67	1,014.33	674.94	517.37	515.96	321.95	321.95	321.95	321.95	321			

Electricity

2018-2019	Sep	Oct	Nov	Dec	Jan	Feb	Mar	Apr	May	Jun	Jul	Aug	Total
High School	20,022.10	16,004.47	13,985.43	12,571.13	12,701.49	14,411.68	12,722.34	15,478.05	16,871.46	16,597.18	16,815.57	21,528.40	189,709.30
MW Academy	271.21	199.10	147.85	123.84	117.57	137.82	115.46	184.26	243.02	289.49	384.65	435.73	2,650.00
Junior High	9,384.43	7,000.42	6,821.27	6,855.84	7,901.36	7,526.86	7,038.19	5,739.45	6,327.74	6,681.61	7,309.58	9,250.23	87,836.98
Travis	7,750.05	5,803.50	4,647.11	4,279.74	4,326.99	4,907.85	4,562.72	4,047.71	4,860.13	4,904.84	5,677.17	7,328.97	63,096.78
Houston	5,227.47	3,728.27	2,557.39	2,096.01	2,535.17	2,723.18	2,449.58	2,376.43	2,911.73	3,060.62	3,632.95	4,734.33	38,033.13
Lamar	8,104.29	6,576.67	4,852.09	3,548.17	4,534.93	5,165.77	4,518.18	4,867.48	5,657.92	5,789.92	5,903.56	7,245.77	66,764.75
DSC	3,203.42	2,410.42	1,672.48	1,608.66	1,729.17	1,870.30	1,609.06	1,868.75	2,232.64	2,892.74	3,161.22	3,854.53	28,113.39
Athletics	5,674.74	5,015.86	4,313.50	4,735.02	5,527.09	7,066.19	6,109.50	4,774.90	3,508.63	3,365.80	3,367.34	4,546.34	58,004.91
Transportation	479.19	473.59	505.78	648.24	747.52	678.67	624.23	453.65	411.95	371.73	402.51	517.93	6,314.99
Total	60,116.90	47,212.30	39,502.90	36,466.65	40,121.29	44,488.32	39,749.26	39,790.68	43,025.22	43,953.93	46,654.55	59,442.23	540,524.23

2019-2020	Sep	Oct	Nov	Dec	Jan	Feb	Mar	Apr	May	Jun	Jul	Aug	Total
High School	22,679.97	19,582.17	14,311.84	14,530.53	431.71	no invoice	38,170.15	21,743.55	10,986.18	12,724.20	14,295.02	17,472.72	186,928.04
MW Academy	444.46	338.01	193.69	376.97	167.87	due to credits	398.06	338.26	272.07	336.76	436.04	440.20	3,742.39
Junior High	10,178.17	8,220.93	7,173.69	14,064.87	14,145.87	see Jan stmt	15,144.03	7,514.17	3,604.14	5,791.60	6,286.20	8,596.11	100,719.78
Travis	8,256.19	6,412.48	4,595.62	9,113.66	9,178.84		8,617.57	4,090.81	3,092.05	4,367.65	5,317.18	6,929.66	69,971.71
Houston	5,345.56	4,378.75	2,817.25	5,459.31	(23,828.38)		(23,101.16)	(25,709.88)	2,036.35	3,154.19	3,826.27	4,522.97	(41,098.77)
Lamar	8,169.94	6,962.42	5,196.58	9,543.70	8,790.10		11,561.93	8,416.85	4,556.69	4,894.83	5,665.99	6,924.68	80,683.71
DSC	3,603.12	2,862.11	1,748.93	3,507.88	3,457.80		3,875.85	2,371.70	1,878.50	2,531.42	3,183.80	3,520.32	32,541.43
Athletics	5,273.56	5,363.28	6,261.44	11,393.38	4,663.76		13,942.82	7,023.54	2,217.78	2,932.28	3,190.79	3,786.40	66,049.03
Transportation	552.56	568.54	740.84	1,462.66	712.99		1,280.45	1,253.73	276.60	425.11	554.09	554.94	8,382.51
Total	64,503.53	54,688.69	43,039.88	69,452.96	17,720.56	-	69,889.70	27,042.73	28,920.36	37,158.04	42,755.38	52,748.00	507,919.83

2020-2021	Sep	Oct	Nov	Dec	Jan	Feb	Mar	Apr	May	Jun	Jul	Aug	Total
High School	18,672.72	14,702.00	16,373.27	9,863.01	11,020.00	11,357.87	11,092.58	12,504.06	14,491.08	14,943.71	15,197.20	17,169.11	167,386.61
MW Academy	284.88	193.34	126.78	113.95	99.36	109.22	136.17	205.01	201.22	318.93	331.30	360.65	2,480.81
Junior High	9,278.42	6,943.37	7,274.86	6,372.17	7,097.54	8,392.06	5,797.66	5,485.33	6,405.18	6,870.01	6,805.28	8,208.69	84,930.57
Travis	7,211.69	4,953.92	4,749.05	3,774.89	4,131.29	4,625.14	3,607.65	3,907.08	4,552.03	4,651.64	4,916.34	6,125.06	57,205.78
Houston	5,038.23	3,274.40	2,816.47	2,128.61	2,200.64	2,351.14	2,179.62	2,284.18	2,862.05	3,486.07	3,760.01	6,030.67	38,412.09
Lamar	7,565.80	4,777.35	7,182.65	3,183.70	3,512.36	4,020.25	3,408.77	3,886.53	4,863.91	5,813.56	5,610.03	4,340.51	58,165.42
DSC	2,950.93	2,245.38	1,900.42	1,421.65	1,503.54	1,457.21	1,347.26	1,555.41	1,754.58	2,490.26	2,697.42	2,954.99	24,279.05
Athletics	6,740.46	5,573.00	5,203.78	5,758.56	5,224.56	7,803.15	6,056.18	5,349.19	4,377.04	4,283.78	3,822.51	4,680.85	64,873.06
Transportation	498.07	509.52	676.65	625.87	648.57	773.83	510.41	534.40	394.35	482.05	531.32	557.08	6,742.12
Total	58,241.20	43,172.28	46,303.93	33,242.41	35,437.86	40,889.87	34,136.30	35,711.19	39,901.44	43,340.01	43,671.41	50,427.61	504,475.51

2021-2022	Sep	Oct	Nov	Dec	Jan	Feb	Mar	Apr	May	Jun	Jul	Aug	Total
High School	23,818.74	16,129.45	14,900.96	13,689.20	14,570.08	14,862.69	14,588.07	18,728.04	21,068.43	20,114.63	19,384.76	20,276.08	212,131.13
MW Academy	271.30	191.55	170.32	164.44	172.12	173.57	148.27	169.00	221.33	221.23	246.65	248.65	2,398.43
Junior High	9,914.99	7,478.83	6,734.43	6,135.46	7,793.75	8,309.59	7,877.54	6,505.79	7,647.38	7,396.75	8,249.87	9,022.37	93,066.75
Travis	6,715.50	5,211.05	4,369.68	3,955.09	4,222.90	4,632.91	4,419.35	4,367.23	5,983.72	5,294.67	6,217.55	7,403.50	62,793.15
Houston	5,077.31	3,658.97	2,999.58	2,445.22	2,532.47	2,724.95	2,511.84	3,031.15	4,215.30	4,059.72	4,461.80	5,029.44	42,747.75
Lamar	6,595.42	5,184.84	4,510.72	4,120.23	4,032.15	3,565.64	3,529.48	4,613.65	6,143.06	6,017.55	6,940.22	7,631.06	62,884.02
DSC	2,994.60	2,277.19	2,035.15	1,669.48	1,559.88	1,500.94	1,456.47	1,843.72	2,424.74	2,870.28	3,656.93	3,718.98	28,008.36
Athletics	798.70	7,052.23	5,986.71	5,894.56	8,067.09	8,494.95	8,534.19	6,156.99	4,333.43	5,796.87	3,862.25	4,537.03	69,515.00
Transportation	596.28	564.94	523.03	671.40		1,461.26	661.42	502.39	423.22	478.50	481.59	474.79	6,838.82
Total	56,782.84	47,749.05	42,230.58	38,745.08	42,950.44	45,726.50	43,726.63	45,917.96	52,460.61	52,250.20	53,501.62	58,341.90	580,383.41

2022-2023	Sep	Oct	Nov	Dec	Jan	Feb	Mar	Apr	May	Jun	Jul	Aug	Total
High School	19,533.27	17,005.63	16,786.45	14,031.29	21,872.41	14,984.39	12,603.49	18,933.81					135,750.74
MW Academy	198.77	161.86	175.86	143.59	165.86	142.52	156.20	132.18					1,276.84
Junior High	8,392.02	6,800.67	7,144.77	6,654.50	7,898.36	7,281.22	5,884.70	5,783.23					55,839.47
Travis	6,909.16	5,374.88	4,341.10	4,394.67	4,392.70	4,284.99	3,741.20	4,039.38					37,478.08
Houston	4,916.77	3,425.24	2,854.53	2,549.01	2,674.16	2,838.47	2,624.04	2,926.75					24,808.97
Lamar	6,801.19	5,327.15	4,440.85	4,496.31	3,823.77	4,208.02	4,439.58	5,061.56					38,598.43
DSC	3,208.13	2,385.87	1,834.35	1,581.62	1,759.59	1,767.44	1,685.49	1,863.31					16,085.80
Athletics	6,847.35	6,387.49	6,875.64	8,190.76	3,530.04	9,530.77	8,524.24	2,419.70					52,305.99
Transportation	462.45	535.20	673.50	739.00	620.13	710.43		962.10					4,702.81
Total	57,269.11	47,403.99	45,127.05	42,780.75	46,737.02	45,748.25	39,658.94	42,122.02	-	-	-	-	366,847.13

Gas

2015-2016	Sep	Oct	Nov	Dec	Jan	Feb	Mar	Apr	May	Jun	Jul	Aug	Total
High School	551.84	876.97	811.28	3,194.39	4,208.18	4,040.01	1,327.14	736.38	423.32	319.76	244.71	324.89	17,058.82
MW Academy	42.55	42.55	42.55	79.84	90.58	103.41	60.93	48.73	43.42	42.55	43.56	42.55	683.22
Junior High	142.55	226.20	566.12	3,189.08	3,424.80	4,077.63	1,607.25	1,021.59	366.05	224.31	158.07	110.35	15,114.00
Travis	152.31	204.71	469.75	3,921.77	2,598.33	2,675.07	1,318.77	566.16	209.93	124.67	104.21	110.55	10,446.23
Houston	126.79	188.27	253.78	1,116.70	1,573.45	1,877.61	915.62	381.99	144.06	131.26	105.11	106.55	6,921.19
Lamar	181.92	247.71	1,023.00	3,139.21	3,676.37	3,066.41	1,095.53	426.77	165.35	87.22	55.40	51.82	13,211.71
DSC	46.22	48.51	202.30	1,397.68	1,703.64	1,598.46	644.44	240.37	114.28	68.93	58.09	59.97	6,182.89
Athletics	42.55	42.55	42.55	42.55	42.55	42.55	42.55	43.49	42.55	42.55	42.55	42.55	511.54
Transportation	52.36	48.51	56.51	727.89	1,034.43	972.76	693.35	105.41	85.59	88.71	90.35	96.15	4,052.02
Total	1,338.09	1,925.93	3,467.84	14,809.11	18,352.33	18,453.91	7,705.58	3,570.89	1,585.55	1,124.96	902.05	945.38	74,181.62

2016-2017	Sep	Oct	Nov	Dec	Jan	Feb	Mar	Apr	May	Jun	Jul	Aug	Total
High School	604.92	973.81	7,123.93	4,204.14	5,986.69	4,607.88	2,605.42	1,593.29	594.71	313.63	228.21	348.17	24,184.87
MW Academy	42.55	44.25	42.55	107.92	185.50	126.77	128.27	77.07	43.59	42.55	43.73	42.55	927.30
Junior High	183.91	262.38	527.74	2,586.04	3,696.92	4,908.83	1,805.30	772.50	447.72	347.24	192.35	86.83	15,817.76
Travis	149.29	194.26	351.21	2,030.50	3,476.95	2,773.33	1,039.06	474.97	246.93	164.07	117.23	114.43	11,132.23
Houston	151.95	192.24	309.48	755.98	446.91	359.19	194.99	90.51	86.03	85.10	85.10	85.10	2,842.58
Lamar	129.85	346.88	1,941.96	2,937.79	4,188.51	2,884.98	1,500.08	492.31	246.22	87.76	47.91	59.44	14,261.65
DSC	42.89	50.63	91.98	1,288.59	1,142.99	1,636.62	715.08	298.26	205.58	135.89	85.85	46.95	6,696.31
Athletics	42.55	42.55	42.55	42.55	42.55	42.55	42.55	43.49	42.55	42.55	42.55	42.55	511.54
Transportation	96.04	107.23	164.20	826.59	1,630.72	1,389.34	280.51	134.65	88.79	74.14	63.51	44.02	4,892.74
Total	1,449.02	2,214.23	4,995.60	14,730.10	21,797.24	18,729.40	8,311.26	3,977.05	2,002.17	1,292.93	906.44	870.04	81,275.98

2017-2018	Sep	Oct	Nov	Dec	Jan	Feb	Mar	Apr	May	Jun	Jul	Aug	Total
High School	615.95	740.47	1,026.91	3,569.45	7,600.59	5,612.48	2,846.87	759.23	569.07	213.11	373.85	430.89	24,358.87
MW Academy	42.55	42.55	63.93	122.50	308.31	182.05	147.86	72.57	35.69	42.55	43.93	42.55	1,166.84
Junior High	163.62	220.76	842.47	2,651.06	4,003.41	4,533.34	2,360.45	1,263.58	463.54	243.79	223.61	237.34	18,008.97
Travis	143.39	167.96	498.06	2,140.69	4,670.36	3,087.28	2,017.47	818.30	446.94	271.96	302.01	292.44	14,856.86
Houston	85.10	85.10	114.81	301.84	501.29	5,862.55	1,316.94	573.74	271.86	130.19	117.73	130.80	9,441.95
Lamar	111.95	160.16	476.27	1,714.44	4,128.15	3,104.00	1,624.58	708.62	281.09	82.49	76.37	97.72	12,565.84
DSC	46.92	56.96	316.45	1,404.65	2,777.14	2,189.25	1,058.18	340.53	172.98	66.93	65.38	67.04	8,562.41
Athletics	42.55	42.55	42.55	42.55	42.55	42.55	42.55	43.49	42.55	42.55	42.55	42.55	511.54
Transportation	44.01	44.35	964.21	1,154.11	1,602.85	1,125.52	470.04	134.63	107.77	76.66	75.18	76.83	5,226.16
Total	1,296.04	1,518.31	3,705.11	13,058.74	26,992.10	25,696.47	11,792.19	4,621.20	2,368.94	1,127.68	1,278.06	1,375.61	94,830.45

2018-2019	Sep	Oct	Nov	Dec	Jan	Feb	Mar	Apr	May	Jun	Jul	Aug	Total
High School	651.89	624.07	1,674.62	4,348.47	6,827.47	5,923.24	4,435.73	1,406.14	337.42	288.36	293.75	242.42	26,863.58
MW Academy	42.55	54.78	123.88	304.70	362.89	283.53	248.16	130.12	82.81	91.57	80.26	80.26	1,805.25
Junior High	241.49	550.95	1,278.47	3,283.51	4,222.67	3,197.52	2,510.40	961.55	159.99	261.28	180.92	92.96	16,941.71
Travis	181.19	403.37	1,339.50	3,160.76	4,000.28	3,391.25	2,571.19	853.66	69.12	231.18	201.06	174.75	16,577.31
Houston	191.14	284.22	881.11	2,365.71	2,912.38	2,286.74	1,857.70	668.57	59.68	209.10	196.27	163.10	12,069.72
Lamar	252.52	482.74	1,695.63	3,456.13	3,591.56	2,664.71	1,335.88	569.71	105.74	159.12	126.62	85.23	15,421.54
DSC	67.40	164.95	830.08	1,771.29	2,210.28	2,162.66	1,648.35	418.15	106.89	156.65	110.63	84.15	9,731.48
Transportation	75.68	200.57	427.34	1,170.85	2,180.86	1,786.57	1,281.68	386.59	26.63	119.39	105.24	80.26	7,841.66
Total	1,713.86	2,765.65	8,250.63	19,661.42	26,308.39	21,696.22	16,689.09	5,494.49	865.47	1,503.84	1,300.06	1,009.13	107,252.25

2019-2020	Sep	Oct	Nov	Dec	Jan	Feb	Mar	Apr	May	Jun	Jul	Aug	Total	
High School	464.81	625.18	1,526.98	7,010.89	4,466.58	3,507.60	1,946.76	1,222.41	50.13	81.26	80.26	77.72	28.94	19,577.74
MW Academy	80.26	81.62	116.46	296.18	224.72	186.79	122.41	50.13	81.26	80.26	77.72	78.79	1,476.60	
Junior High	142.74	221.36	580.81	3,433.90	2,852.83	2,116.85	856.97	347.04	227.84	195.09	194.24	260.13	11,229.70	
Travis	192.36	223.34	616.99	4,662.23	3,112.81	2,707.19	1,530.91	391.33	211.76	180.41	176.28	177.97	14,181.37	
Houston	219.09	247.48	526.45	2,964.78	1,801.49	1,516.39	724.71	316.08	183.32	172.28	156.63	171.71	9,000.41	
Lamar	120.35	147.06	618.99	4,783.68	1,249.52	1,688.13	890.36	322.54	87.41	82.59	77.72	100.25	10,168.60	
DSC	81.54	81.87	326.05	2,127.94	1,769.88	1,338.12	526.54	154.62	152.94	143.43	139.44	151.56	6,993.93	
Transportation	81.54	82.33	382.81	1,852.51	1,794.77	975.09	533.94	141.70	100.51	103.67	91.96	91.64	5,732.47	
Total	1,382.69	1,710.24	4,695.54	27,132.01	16,771.68	14,036.16	6,932.60	1,723.44	1,045.04	957.73	914.50	1,060.99	78,362.62	

2020-2021	Sep	Oct	Nov	Dec	Jan	Feb	Mar	Apr	May	Jun	Jul	Aug	Total
High School	297.29	1,344.73	2,438.19	6,238.04	5,158.02	7,437.69	2,340.61	788.08	561.32	780.27	189.71	497.62	27,548.57
MW Academy	78.31	120.49	227.69	327.49	293.46	239.32	198.64	47.90	85.44	79.06	110.60	109.09	1,937.49
Junior High	393.28	747.38	1,588.53	2,981.87	2,951.05	3,649.25	1,644.94	555.17	433.29	279.07	303.14	392.59	15,719.56
Travis	179.08	769.96	2,049.26	4,396.13	3,417.63	4,215.44	1,359.11	410.30	271.24	172.89	232.25	277.88	17,751.17
Houston	179.67	566.94	1,334.29	2,138.18	2,486.13	3,011.99	1,230.02	373.02	270.14	199.87	260.62	296.60	12,347.47
Lamar	112.49	690.06	1,963.33	4,220.46	3,392.19	4,754.40	1,037.44	327.64	188.96	112.84	107.78	151.42	17,058.81
DSC	113.90	495.28	1,135.52	2,109.58	2,474.40	2,972.82	665.70	215.11	196.57	168.17	192.58	204.40	10,951.03
Transportation	113.63	572.83	1,248.58	1,636.42	1,547.22	1,437.43	624.59	387.95	175.24	104.70	127.81	128.04	8,104.44
Total	1,267.85	5,307.67	11,985.39	24,048.17	21,720.10	27,738.34	9,101.05	3,109.17	2,184.20	1,996.67	1,531.49	2,052.64	111,442.54

2021-2022	Sep	Oct	Nov	Dec	Jan	Feb	Mar	Apr	May	Jun	Jul	Aug	Total
High School	793.89	1,007.48	2,358.19	7,490.34	7,750.28	8,307.96	3,800.23	6,344.93	562.20	423.69	457.13	978.53	40,274.85
MW Academy	109.33	113.05	138.11	252.67	322.42	364.83	245.82	89.06	109.77	111.44	109.81	109.75	2,076.07
Junior High	477.98	788.46	2,164.93	3,400.41	3,777.03	4,150.81	2,122.82	1,603.33	446.82	397.52	391.98	600.56	20,322.65
Travis	335.36	557.74	2,449.02	3,874.12	4,165.75	4,574.51	2,680.63						



BOARD OF TRUSTEES Agenda Item

MEETING DATE: 6/12/23

MEETING TYPE:

- Regular Meeting
- Special Meeting

AGENDA ITEM TYPE:

- Action Item
- Non-Action Item

BOARD GOALS (check all that apply)

Academic Goals

- Academic Competitiveness
 - Early Literacy (HB3)
 - Early Math (HB3)
 - Other
- Career Certifications (HB3)

Operational Goals

- Promote Community/School Partnerships
- Fiscal Responsibility
- Safe and Secure Schools

TITLE: Discuss, Consider, and Take Any Necessary Action Regarding the Minutes of the May 8, 2023 Regular Meeting, May 4, 2023 Special Meeting of the Board, May 19, 2023, Special Meeting of the Board, and May 30, 2023, Special Meeting of the Board

RECOMMENDED ACTION: It is recommended that the May 8, May 4, May 19, and May 30 Minutes be approved as presented.

BOARD POLICY/STATE REGULATION/LAW REFERENCE (if applicable): BE(LOCAL)

OVERVIEW:

Review and approve minutes from May 8, 2023 Regular Meeting of the Board, May 4, 2023 Special Meeting of the Board, May 19, 2023 Special Meeting of the Board, and May 30, 2023, Special Meeting of the Board of Trustees

FISCAL IMPACT: N/A

ATTACHMENTS: Minutes

DEPARTMENT(S) SUBMITTING FORM: Superintendent

DEPARTMENT SIGNATURE/APPROVAL: 

**MINERAL WELLS INDEPENDENT SCHOOL DISTRICT
MINERAL WELLS, TEXAS**

SUBJECT: Minutes of Workshop/Special Called Board Meeting
PLACE: Boardroom/District Services Complex
DATE: May 4, 2023
TIME: 6:00 p.m.

Board Members Present: Maria Jones, President
Donna Henderson
Brandon Hons
Lauretta Poole
Joe Ruelas

Board Members Absent: Greg Malone
Sunny Lee, Vice President

Central Administrators Present: David Tarver, Assistant Superintendent
Natalie Griffin, Executive Director of Special Programs

Call to Order/Establish Quorum: The special called meeting was called to order at 12:00 p.m.

Closed Session The Board adjourned into closed session at 12:01 p.m. No action was taken in closed session.

Open Session The board reconvened into open session at 12:20 p.m.

Action Items:

Contract for Athletic Director Candidate Joe Ruelas moved and Donna Henderson seconded a motion to hire Cody Worrell as the new Athletic Director for MWISD. ***The motion carried 5-0.***

Public Comment No one registered for Public Comment.

Adjournment Upon a motion by Joe Ruelas and seconded by Donna Henderson the meeting was adjourned at 12:24 p.m. ***The motion passed 5-0.***

Maria Jones, President

Joe Ruelas, Secretary

sc

**MINERAL WELLS INDEPENDENT SCHOOL DISTRICT
MINERAL WELLS, TEXAS**

SUBJECT: Minutes of Workshop/Regular Board Meeting
PLACE: Boardroom/District Services Complex
DATE: May 8, 2023
TIME: 5:30 p.m.

Board Members Present: Brandon Hons
Sunny Lee, Vice President
Donna Henderson
Greg Malone
Joe Ruelas, Secretary
Lauretta Poole

Board Members Absent: Maria Jones, President

Central Administrators Present: Dr. John Kuhn, Superintendent
David Tarver, Assistant Superintendent
Natalie Griffin, Executive Director of Special Programs
Angie Myrick, Executive Director of Curriculum
Kenzie King, Executive Director of Counseling and Assessments

Call to Order/Establish Quorum: The regular meeting was called to order at 5:30 p.m. by Maria Jones, President. Let the record show that a quorum of board members was present, that this meeting had been duly called, and that notice of this meeting had been posted.

Board Workshop/Dinner: The Board workshop started at 5:30 p.m. and ended at 6:33 p.m. No action was taken during the workshop.

Closed Session – Texas Government Code 551.074: The Board adjourned into closed session at 6:33 p.m. The closed session ended at 7:06 p.m. No action was taken in closed session.

Open Session: The Board reconvened in open session at 7:06 p.m.

Prayer: Donna Henderson opened the meeting with prayer.

Pledges – U.S./Texas Flags: The Board led the audience in the Pledges of Allegiance.

Mission & Vision Statements: Greg Malone read the Mission and Vision Statements.

Public Comment No one registered for Public Comment.

President’s Report: Maria Jones, President, was absent, therefore there was no report given.

Special Recognition

Karyn Bullock identified students who received the Texas High School Coaches Association Academic All State Recognition:

State Recognition

Timmy Corzine
Jewelissa Vega
Felipe Velasquez
Camila Andrade
Rosalind Hernandez
Jennifer Lopez
Jessenia Munoz

Superintendent's Report:

Enrollment Report

Dr. John Kuhn, Superintendent stated that we have 130 more students than this time last year. Attendance is at 93.6 percent district wide.

**School Health Advisory
Committee Annual Report
2022-2023**

Sylvia Saucedo, SHAC Chairman, gave a quick overview on the projects that SHAC is working on. The school store has been put on hold but will be re-evaluated for next year. They are also looking at the vaping problems and what can be done to help improve it.

**Discussion on the
Conditions of the
Greenhouse**

Trey Evans and DeeAnn Hampton presented a slideshow of the conditions of the current greenhouse. It was decided that the current greenhouse is no longer safe for students to use. They recommended looking into purchasing a new one for next year.

Action Items:

Consent Agenda Items:

- A. Monthly Financial Reports and Accounts Payable Listing
- B. Water/Electricity/Gas Reports
- C. Minutes of the April 10, 2023 Regular Meeting of the Board of Trustees

Joe Ruelas moved and Donna Henderson seconded a motion to approve the consent agenda items as presented. ***The motion carried 6-0. (copies attached)***

**Discuss, Consider, and
Take Any Necessary Action
Regarding the Adoption of
a Resolution Pertaining to
Vouchers, Education
Savings Accounts, and
Taxpayer Savings Grants**

Joe Ruelas moved and Laurretta Poole seconded a motion to approve a Resolution Pertaining to Vouchers, Education Savings Accounts, and Taxpayer Savings Grants. ***The motion carried 6-0. (copies attached)***

Discuss, Consider, and Take Any Necessary Action Regarding a Waiver for Missed Instructional Days for Mineral Wells ISD

Joe Ruelas moved and Greg Malone seconded a motion to approve a Waiver for Missed Instructional Days for Mineral Wells ISD as presented. ***The motion carried 6-0. (copies attached)***

Discuss, Consider, and Take Any Necessary Action Regarding the 2023-2024 Allotment & TEKS Certification Form

Joe Ruelas moved and Laretta Poole seconded a motion to approve the 2023-2024 Allotment & TEKS Certification Form as presented. ***The motion carried 6-0. (copies attached)***

Discuss, Consider, and Take Any Necessary Action Regarding MWISD entering into an agreement with the Region 11 Education Service Center for a Variety of Educational Services

Joe Ruelas moved and Brandon Hons seconded a motion to approve entering into an agreement with the Region 11 Education Service Center for a Variety of Educational Services as presented. ***The motion carried 6-0. (copy attached)***

Information Items:

Calendars for May and June

The board was given calendars for the months of May and June 2023.

Adjournment

Upon a motion by Joe Ruelas and seconded by Greg Malone, the meeting was adjourned at 7:45 p.m. ***The motion passed 6-0.***

Maria Jones, President

Joe Ruelas, Secretary

sc

**MINERAL WELLS INDEPENDENT SCHOOL DISTRICT
MINERAL WELLS, TEXAS**

SUBJECT: Minutes of Special Called Board Meeting
PLACE: Boardroom/District Services Complex
DATE: May 19, 2023
TIME: 12:00 P.M.

Board Members Present: Maria Jones, President
Brandon Hons
Lauretta Poole
Joe Ruelas
Greg Malone

Board Members Absent: Sunny Lee, Vice President
Donna Henderson

Central Administrators Present: David Tarver, Assistant Superintendent
John Kuhn, Superintendent
Kenzie King
Natalie Griffin
Angie Myrick

Call to Order/Establish Quorum: The special meeting was called to order 12:00 p.m. by Maria Jones, President. Let the record show that a quorum of board members was present, that this meeting had been duly called, and that notice of this meeting had been posted.

Open Session

Action Items

Discuss, Consider, and Take Any Necessary Action Regarding the Adoption of a Resolution Regarding Policy FMH (LOCAL), Student Activities Joe Ruelas moved and Lauretta Poole seconded a motion to approve the Resolution Regarding Policy FMH (LOCAL), Student Activities as presented. ***The motion carried 5-0.***

Public Comment No one registered for Public Comment.

Adjournment Upon a motion by Joe Ruelas and seconded by Greg Malone, the meeting was adjourned at 12:10 p.m. ***The motion passed 5-0.***

Maria Jones, President

Joe Ruelas, Secretary

SC

**MINERAL WELLS INDEPENDENT SCHOOL DISTRICT
MINERAL WELLS, TEXAS**

SUBJECT: Minutes of Special Called Board Meeting
PLACE: Boardroom/District Services Complex
DATE: May 30, 2023
TIME: 5:00 P.M.

Board Members Present: Maria Jones, President
Brandon Hons
Lauretta Poole
Sunny Lee, Vice President
Greg Malone

Board Members Absent: Joe Ruelas, Secretary
Donna Henderson

Central Administrators Present: David Tarver, Assistant Superintendent
John Kuhn, Superintendent

Call to Order/Establish Quorum: The special meeting was called to order at 5:00 p.m. by Maria Jones, President. Let the record show that a quorum of board members was present, that this meeting had been duly called, and that notice of this meeting had been posted.

Closed Session The board went into closed session at 5:00 p.m. and came out at 6:04 p.m.

Open Session The board resumed into open session at 6:04 p.m.

Action Items

Discuss, Consider, and Take Any Necessary Action Regarding the Hiring of Mineral Wells Jr. High Principal Greg Malone moved and Lauretta Poole seconded a motion to approve the hiring of Eric Rivas as the Mineral Wells Jr. High School Principal. ***The motion carried 5-0.***

Public Comment No one registered for Public Comment.

Adjournment Upon a motion by Greg Malone and seconded by Maria Jones, the meeting was adjourned at 6:06 p.m. ***The motion passed 5-0.***

Maria Jones, President

Joe Ruelas, Secretary

sc



BOARD OF TRUSTEES Agenda Item

MEETING DATE: 6/12/23

MEETING TYPE:

- Regular Meeting
- Special Meeting

AGENDA ITEM TYPE:

- Action Item
- Non-Action Item

BOARD GOALS (check all that apply)

Academic Goals

- Academic Competitiveness
 - Early Literacy (HB3)
 - Early Math (HB3)
 - Other
- Career Certifications (HB3)

Operational Goals

- Promote Community/School Partnerships
- Fiscal Responsibility
- Safe and Secure Schools

TITLE: Proposed Budget Calendar

RECOMMENDED ACTION: This item is for information only.

BOARD POLICY/STATE REGULATION/LAW REFERENCE (if applicable):

OVERVIEW:

See attached calendar

Budget planning shall be an integral part of overall program planning so that the budget effectively reflects the District's programs and activities and provides the resources to implement them. In the budget planning process, general educational goals, specific program goals, and alternatives for achieving program goals shall be considered, as well as input from the District and campus level planning and decision making committees. Budget planning and evaluation are continuous processes and shall be a part of each month's activities.

FISCAL IMPACT: N/A

ATTACHMENTS: Budget Calendar

DEPARTMENT(S) SUBMITTING FORM: Business and Finance

DEPARTMENT SIGNATURE/APPROVAL:

Proposed Budget Schedule:

June 12, Monday	Propose budget schedule at regular board meeting
August 7, Monday	1st Budget workshop 5:30
August 14, Monday	Announce tentative tax rate and set meeting for adoption of final budget, new budget and tax rate (Aug. 28)
August 21, Monday	2nd Budget workshop 5:30 (If needed)
August 28, Monday	Approve final 2022-2023 budget amendment, adopt 2023-2024 budget and set tax rates - 5:30



BOARD OF TRUSTEES
Agenda Item

MEETING DATE: 6/12/23

MEETING TYPE:	AGENDA ITEM TYPE:
<input checked="" type="checkbox"/> Regular Meeting	<input checked="" type="checkbox"/> Action Item
<input type="checkbox"/> Special Meeting	<input type="checkbox"/> Non-Action Item

BOARD GOALS (check all that apply)

Academic Goals	Operational Goals
<input type="checkbox"/> Academic Competitiveness	<input type="checkbox"/> Promote Community/School Partnerships
• <input type="checkbox"/> Early Literacy (HB3)	<input checked="" type="checkbox"/> Fiscal Responsibility
• <input type="checkbox"/> Early Math (HB3)	<input type="checkbox"/> Safe and Secure Schools
• <input type="checkbox"/> Other	
<input type="checkbox"/> Career Certifications (HB3)	

TITLE: Discuss, Consider, and Take Any Necessary Action Regarding the Interlocal Agreement for Assessment and Collection of Property Taxes

RECOMMENDED ACTION: It is recommended that the Interlocal Agreement for Assessment and Collection of Property Taxes for the Year 2023-2024 be approved as presented

BOARD POLICY/STATE REGULATION/LAW REFERENCE (if applicable): Education Code 45.231; Tax Code 6.22(c) and 6.24(a)

OVERVIEW:

The Board may employ a person to assess or collect the District's taxes and may compensate the person as the Board considers appropriate. Education Code 45.231

The District may also provide for the assessment or collection of the District's taxes under one of the following methods:

1. Require the county to assess and collect taxes for the District. The Board may revoke the requirement at any time by official action. Tax Code 6.22(c)
2. Contract with another taxing unit or the county appraisal district(s) to perform duties relating to the assessment or collection of taxes. Tax Code 6.24(a)

FISCAL IMPACT: Tax Revenue

ATTACHMENTS: Interlocal Agreement for Assessment and Collection of Property Taxes

DEPARTMENT(S) SUBMITTING FORM: Business and Finance

DEPARTMENT SIGNATURE/APPROVAL:

THE STATE OF TEXAS

COUNTY OF PALO PINTO

CONTRACT FOR ASSESSMENT AND COLLECTION SERVICES

On this the 1st day of August 2023, the Palo Pinto County Tax Assessor-Collector and the MINERAL WELLS INDEPENDENT SCHOOL DISTRICT, (hereinafter called "Taxing Unit"), enter into the following agreement for a period of one year from the date above.

PURPOSE

The parties to this agreement wish to consolidate the assessment and collection of property taxes with Palo Pinto County Tax Assessor-Collector. The Taxing Unit enters this agreement to eliminate the duplication of services and to promote governmental efficiency.

The parties enter this contract pursuant to the authority granted by Section 6.24, Texas Property Tax Code, and Interlocal Cooperation Act, Government Code Chapter 791.

SERVICES TO BE PERFORMED

- (1) The county shall collect taxes owing to the Taxing Unit. The county further agrees to perform for the Taxing Unit all the duties provided by the law of the State of Texas for the collection of taxes for the said Taxing Unit.
- (2) The county shall collect the taxes levied by the Taxing Unit on property located in Palo Pinto County. The Taxing Unit will contract with a third party to provide for the collection of taxes levied on property located outside the boundary of Palo Pinto County.
- (3) The county shall perform all the functions in the definitions section of this contract. Specifically, the County agrees to prepare tax statements for all parcels of property located in Palo Pinto County. The county shall mail said tax statement to each taxpayer.
- (4) Each Taxing Unit hereby designates the county Tax Assessor-Collector as its Tax Assessor-Collector for purpose of compliance with the Property Tax Code. In addition, the parties agree that the Tax Assessor-Collector shall perform all the duties of the Tax Assessor-Collector of the taxing unit as set forth in Chapters 31 and 33 of the Property Tax Code. The Taxing Unit hereby also specifically designates the Tax Assessor-Collector as the person to fulfill the duties outlined in Chapter 26 of the Code on behalf of the Taxing Unit.
- (5) The county shall issue tax certificates by the authority granted by Section 31.08 of the Property Tax Code. Said fee for tax certificate to be retained by the county to cover cost of this service.

PAYMENT

- (1) The county has estimated its cost of assessing and collecting taxes for all participating taxing units for the period of this contract during the normal budgeting process. The estimate of the cost of assessing and collecting has been approved in the same manner as the rest of the budget.
- (2) Based upon budgeted estimates and methods set forth in paragraph (1) of this Section, the Taxing Unit agrees to pay the Palo Pinto County Tax Assessor-Collector one Percent (1%) of the gross taxes collected for services rendered during the term of this contract.

REMITTANCE OF COLLECTIONS

During the tax collection year, disbursements shall be made to the Taxing Unit on a weekly basis by the Tax Assessor-Collector.

LOCATION OF TAX OFFICE

The tax assessing and collecting office shall be located during the term of this contract within the Courthouse of Palo Pinto County, Palo Pinto, Texas as determined by the Commissioners Court.

ADMINISTRATIVE PROVISIONS

- (1) The County shall not be liable to the Taxing Unit because of any failure to collect taxes nor shall the Tax Assessor-Collector be liable unless the failure to collect taxes results from some failure on his part to perform the duties imposed upon him by law and by this agreement.
- (2) An annual audit of Palo Pinto County operations, including operations of the Tax Assessor-Collector's office, shall be made by an independent certified public accountant selected by the County. The costs and expenses related to such audit shall be paid with general operation funds of the County. The annual Audit Report, performed in accordance with generally accepted accounting principles, shall be available upon request to the Taxing Unit.

DELINQUENT TAX COLLECTIONS

The Tax Assessor-Collector of the County of Palo Pinto shall be required to exert a good faith effort to collect taxes due and payable for the benefit of the Taxing Unit when and if same shall have become delinquent by mailing adequate notices to such delinquent taxpayers in a timely manner. Such notices shall include information regarding the tax years being delinquent and information related to penalties, interest and related costs that may become due and payable prior to turning such delinquent accounts over to an attorney for additional collection efforts.

Pursuant to section 6.30(b) of the Texas Property Tax Code, the Taxing Unit hereby expressly authorizes the County to contract with an attorney to enforce, through all lawful remedies, the collection of the Taxing Unit's delinquent taxes.

DEFINITIONS

For purpose of this agreement the terms "Assessment and Collections" shall include the following: calculation of tax, preparation of tax rolls, proration of taxes, correction of clerical errors in tax rolls, collection of current liabilities, collections of delinquent taxes, issuance of refunds, and calculations of an effective tax rate required by the Property Tax Code.

Executed at Palo Pinto, Texas on the ___ day of _____, 2023.

 SHANE LONG
 COUNTY JUDGE
 PALO PINTO COUNTY
 PALO PINTO, TEXAS

 STACY L. CHOATE
 TAX ASSESSOR-COLLECTOR
 PALO PINTO COUNTY
 PALO PINTO, TEXAS

ATTEST:

 JANETTE K. GREEN
 COUNTY CLERK
 PALO PINTO COUNTY
 PALO PINTO, TEXAS

ATTEST:

TAXING UNIT:

 SECRETARY

 AUTHORIZED REPRESENTATIVE

THE STATE OF TEXAS

COUNTY OF PALO PINTO

CONTRACT FOR ASSESSMENT AND COLLECTION SERVICES

On this the 1st day of August 2023, the Palo Pinto County Tax Assessor-Collector and the MINERAL WELLS INDEPENDENT SCHOOL DISTRICT, (hereinafter called "Taxing Unit"), enter into the following agreement for a period of one year from the date above.

PURPOSE

The parties to this agreement wish to consolidate the assessment and collection of property taxes with Palo Pinto County Tax Assessor-Collector. The Taxing Unit enters this agreement to eliminate the duplication of services and to promote governmental efficiency.

The parties enter this contract pursuant to the authority granted by Section 6.24, Texas Property Tax Code, and Interlocal Cooperation Act, Government Code Chapter 791.

SERVICES TO BE PERFORMED

- (1) The county shall collect taxes owing to the Taxing Unit. The county further agrees to perform for the Taxing Unit all the duties provided by the law of the State of Texas for the collection of taxes for the said Taxing Unit.
- (2) The county shall collect the taxes levied by the Taxing Unit on property located in Palo Pinto County. The Taxing Unit will contract with a third party to provide for the collection of taxes levied on property located outside the boundary of Palo Pinto County.
- (3) The county shall perform all the functions in the definitions section of this contract. Specifically, the County agrees to prepare tax statements for all parcels of property located in Palo Pinto County. The county shall mail said tax statement to each taxpayer.
- (4) Each Taxing Unit hereby designates the county Tax Assessor-Collector as its Tax Assessor-Collector for purpose of compliance with the Property Tax Code. In addition, the parties agree that the Tax Assessor-Collector shall perform all the duties of the Tax Assessor-Collector of the taxing unit as set forth in Chapters 31 and 33 of the Property Tax Code. The Taxing Unit hereby also specifically designates the Tax Assessor-Collector as the person to fulfill the duties outlined in Chapter 26 of the Code on behalf of the Taxing Unit.
- (5) The county shall issue tax certificates by the authority granted by Section 31.08 of the Property Tax Code. Said fee for tax certificate to be retained by the county to cover cost of this service.

PAYMENT

- (1) The county has estimated its cost of assessing and collecting taxes for all participating taxing units for the period of this contract during the normal budgeting process. The estimate of the cost of assessing and collecting has been approved in the same manner as the rest of the budget.
- (2) Based upon budgeted estimates and methods set forth in paragraph (1) of this Section, the Taxing Unit agrees to pay the Palo Pinto County Tax Assessor-Collector one Percent (1%) of the gross taxes collected for services rendered during the term of this contract.

REMITTANCE OF COLLECTIONS

During the tax collection year, disbursements shall be made to the Taxing Unit on a weekly basis by the Tax Assessor-Collector.

LOCATION OF TAX OFFICE

The tax assessing and collecting office shall be located during the term of this contract within the Courthouse of Palo Pinto County, Palo Pinto, Texas as determined by the Commissioners Court.

ADMINISTRATIVE PROVISIONS

- (1) The County shall not be liable to the Taxing Unit because of any failure to collect taxes nor shall the Tax Assessor-Collector be liable unless the failure to collect taxes results from some failure on his part to perform the duties imposed upon him by law and by this agreement.
- (2) An annual audit of Palo Pinto County operations, including operations of the Tax Assessor-Collector's office, shall be made by an independent certified public accountant selected by the County. The costs and expenses related to such audit shall be paid with general operation funds of the County. The annual Audit Report, performed in accordance with generally accepted accounting principles, shall be available upon request to the Taxing Unit.

DELINQUENT TAX COLLECTIONS

The Tax Assessor-Collector of the County of Palo Pinto shall be required to exert a good faith effort to collect taxes due and payable for the benefit of the Taxing Unit when and if same shall have become delinquent by mailing adequate notices to such delinquent taxpayers in a timely manner. Such notices shall include information regarding the tax years being delinquent and information related to penalties, interest and related costs that may become due and payable prior to turning such delinquent accounts over to an attorney for additional collection efforts.

Pursuant to section 6.30(b) of the Texas Property Tax Code, the Taxing Unit hereby expressly authorizes the County to contract with an attorney to enforce, through all lawful remedies, the collection of the Taxing Unit's delinquent taxes.

DEFINITIONS

For purpose of this agreement the terms "Assessment and Collections" shall include the following: calculation of tax, preparation of tax rolls, proration of taxes, correction of clerical errors in tax rolls, collection of current liabilities, collections of delinquent taxes, issuance of refunds, and calculations of an effective tax rate required by the Property Tax Code.

Executed at Palo Pinto, Texas on the ___ day of _____, 2023.

SHANE LONG
COUNTY JUDGE
PALO PINTO COUNTY
PALO PINTO, TEXAS

STACY L. CHOATE
TAX ASSESSOR-COLLECTOR
PALO PINTO COUNTY
PALO PINTO, TEXAS

ATTEST:

JANETTE K. GREEN
COUNTY CLERK
PALO PINTO COUNTY
PALO PINTO, TEXAS

ATTEST:

TAXING UNIT:

SECRETARY

AUTHORIZED REPRESENTATIVE



BOARD OF TRUSTEES Agenda Item

MEETING DATE: 6/12/23

MEETING TYPE:

- Regular Meeting
- Special Meeting

AGENDA ITEM TYPE:

- Action Item
- Non-Action Item

BOARD GOALS (check all that apply)

Academic Goals

- Academic Competitiveness
 - Early Literacy (HB3)
 - Early Math (HB3)
 - Other
- Career Certifications (HB3)

Operational Goals

- Promote Community/School Partnerships
- Fiscal Responsibility
- Safe and Secure Schools

TITLE: FIRST READING: Local District Update 121, affecting local policies (see attached list)

RECOMMENDED ACTION: The Board will have the opportunity to review Localized Policy Manual Update 121 during the month of June, it will be placed on the July board agenda for consideration/action.

BOARD POLICY/STATE REGULATION/LAW REFERENCE (if applicable): BF(LOCAL)

OVERVIEW:

A school board is authorized to develop and amend local policies so long as policies adopted and amended do not conflict with law. Update 121 contains numerous updates and revisions to board policies.

FISCAL IMPACT: N/A

ATTACHMENTS: Update 121

DEPARTMENT(S) SUBMITTING FORM: Superintendent's Office

DEPARTMENT SIGNATURE/APPROVAL: 

Instruction Sheet

TASB Localized Policy Manual Update 121

Mineral Wells ISD

Code	Type	Action To Be Taken	Note
AC	(LEGAL)	Replace policy	Revised policy
AF	(LEGAL)	Replace policy	Revised policy
AIE	(LEGAL)	Replace policy	Revised policy
BBBA	(LEGAL)	Replace policy	Revised policy
BQ	(LEGAL)	Replace policy	Revised policy
C	(LEGAL)	Replace table of contents	Revised table of contents
CBB	(LEGAL)	Replace policy	Revised policy
CCA	(LEGAL)	Replace policy	Revised policy
CCGA	(LEGAL)	Replace policy	Revised policy
CCGB	(LEGAL)	Replace policy	Revised policy
CFB	(LOCAL)	Replace policy	Revised policy
CH	(LEGAL)	Replace policy	Revised policy
CKE	(LOCAL)	DELETE policy	See explanatory note
CKEC	(LOCAL)	ADD policy	See explanatory note
CL	(LEGAL)	Replace policy	Revised policy
CLA	(LEGAL)	Replace policy	Revised policy
CLB	(LEGAL)	Replace policy	Revised policy
CLB	(LOCAL)	Replace policy	Revised policy
CMD	(LEGAL)	Replace policy	Revised policy
CNC	(LEGAL)	Replace policy	Revised policy
CO	(LEGAL)	Replace policy	Revised policy
CQ	(LEGAL)	Replace policy	Revised policy
CQA	(LEGAL)	Replace policy	Revised policy
CRF	(LOCAL)	Replace policy	Revised policy
CSA	(LEGAL)	No policy enclosed	See explanatory note
CVA	(LOCAL)	Replace policy	Revised policy
CVB	(LOCAL)	Replace policy	Revised policy
DBAA	(LEGAL)	Replace policy	Revised policy
DEA	(LOCAL)	Replace policy	Revised policy
DEAB	(LEGAL)	Replace policy	Revised policy
E	(LEGAL)	Replace table of contents	Revised table of contents
EF	(LEGAL)	Replace policy	Revised policy
EHAD	(LEGAL)	Replace policy	Revised policy
EHBAB	(LEGAL)	Replace policy	Revised policy

Instruction Sheet
TASB Localized Policy Manual Update 121

Mineral Wells ISD

Code	Type	Action To Be Taken	Note
EHBAF	(LEGAL)	Replace policy	Revised policy
EHBC	(LEGAL)	Replace policy	Revised policy
EHBCA	(LEGAL)	ADD policy	See explanatory note
EBBH	(LEGAL)	Replace policy	Revised policy
EHBI	(LEGAL)	Replace policy	Revised policy
EHBJ	(LEGAL)	Replace policy	Revised policy
EI	(LEGAL)	Replace policy	Revised policy
EKB	(LEGAL)	Replace policy	Revised policy
FD	(LEGAL)	Replace policy	Revised policy
FD	(LOCAL)	Replace policy	Revised policy
FDA	(LEGAL)	Replace policy	Revised policy
FDC	(LEGAL)	Replace policy	Revised policy
FEA	(LEGAL)	Replace policy	Revised policy
FEB	(LEGAL)	Replace policy	Revised policy
FFAF	(LEGAL)	Replace policy	Revised policy
FFC	(LEGAL)	Replace policy	Revised policy
FFI	(LEGAL)	Replace policy	Revised policy
FFI	(LOCAL)	Replace policy	Revised policy
FL	(LEGAL)	Replace policy	Revised policy
G	(LEGAL)	Replace table of contents	Revised table of contents
GB	(LEGAL)	Replace policy	Revised policy
GBA	(LEGAL)	Replace policy	Revised policy
GBAA	(LEGAL)	Replace policy	Revised policy
GRA	(LEGAL)	Replace policy	Revised policy

Explanatory Notes

TASB Localized Policy Manual Update 121

Mineral Wells ISD

AC(LEGAL) GEOGRAPHIC BOUNDARIES

This legal policy has been revised to include additional Education Code provisions related to ways in which a district's geographic boundaries may change, such as by detachment, annexation, consolidation, and abolition.

AF(LEGAL) INNOVATION DISTRICTS

Amended Administrative Code rules, effective October 25, 2022, revised the list of Education Code sections and administrative rules from which a district of innovation may not be exempted. Changes include a requirement to provide TEA a link to the local innovation plan posted on the district's website. Previously, the rule required the district to provide TEA with a copy of the local innovation plan.

AIE(LEGAL) ACCOUNTABILITY: INVESTIGATIONS

Changes reflect revised Administrative Code provisions regarding compliance investigations by TEA, effective October 26, 2022. Other changes are to better reflect legal sources.

BBBA(LEGAL) ELECTIONS: CONDUCTING ELECTIONS

Provisions regarding confidentiality of the email address and personal phone number of an election judge or clerk have been moved from GBA(LEGAL) to this code addressing elections.

BQ(LEGAL) PLANNING AND DECISION-MAKING PROCESS

An existing requirement to include the district's bullying prevention policy and procedures in the district improvement plan has been added to this policy.

C(LEGAL) BUSINESS AND SUPPORT SERVICES

The C section table of contents has been revised to add the new code CKED, Security Personnel: Other Security Arrangements. We have also added for future expansion new codes addressing facility standards at CSA (Safety and Security) and CSB (Gas and Pipelines).

CBB(LEGAL) STATE AND FEDERAL REVENUE SOURCES: FEDERAL

Revisions are to better reflect legal sources.

CCA(LEGAL) LOCAL REVENUE SOURCES: BOND ISSUES

Citations have been updated to reflect the repeal and replacement of an Administrative Code provision regarding the bond guarantee program, effective March 1, 2023. References to Administrative Code provisions regarding the instructional facilities allotment and existing debt allotment have been clarified.

CCGA(LEGAL) AD VALOREM TAXES: EXEMPTIONS AND PAYMENTS

This policy has been revised to reflect the increased homestead exemption of \$40,000 approved by voters on May 7, 2022.

CCGB(LEGAL) AD VALOREM TAXES: ECONOMIC DEVELOPMENT

We have added a note regarding the expiration of the Texas Economic Development Act on December 31, 2022, and the continued application of the law to limitations on appraised value in existence at that time.

Explanatory Notes

TASB Localized Policy Manual Update 121

Mineral Wells ISD

CFB(LOCAL) ACCOUNTING: INVENTORIES

Revisions regarding the capitalization threshold are based on amended guidance from *GASB Implementation Guide 2021-1*, Question 5.1, regarding the capitalization of assets with individual acquisition costs below the threshold if the assets in the aggregate are significant. The amended guidance applies to reporting periods beginning after June 15, 2023.

CH(LEGAL) PURCHASING AND ACQUISITION

We have replaced the citation to a repealed Administrative Code rule regarding purchases of automated information systems with a citation to a new rule effective December 19, 2022.

CKE(LOCAL) SAFETY PROGRAM/RISK MANAGEMENT: SECURITY PERSONNEL

To better align the district's legal and local policies, provisions addressing school resource officers have been relocated to CKEC(LOCAL).

CKEC(LOCAL) SECURITY PERSONNEL: SCHOOL RESOURCE OFFICERS

Provisions addressing school resource officers have been relocated to this code from CKE(LOCAL). Please review the provisions for accuracy. If revisions are needed regarding other security personnel, please contact your policy consultant.

CL(LEGAL) BUILDINGS, GROUNDS, AND EQUIPMENT MANAGEMENT

We have replaced the citation to repealed Administrative Code provisions regarding public pool sanitation and safety with a citation to new provisions effective January 1, 2023.

CLA(LEGAL) BUILDINGS, GROUNDS, AND EQUIPMENT MANAGEMENT: SECURITY

New Administrative Code rules, effective February 2, 2023, have been added to address required warning signs regarding human trafficking.

CLB(LEGAL) BUILDINGS, GROUNDS, AND EQUIPMENT MANAGEMENT: MAINTENANCE

Changes reflect revisions to Administrative Code rules regarding integrated pest management, effective January 16, 2023.

CLB(LOCAL) BUILDINGS, GROUNDS, AND EQUIPMENT MANAGEMENT: MAINTENANCE

Administrative Code rules regarding integrated pest management (IPM) were amended to include district-owned residential property among the district facilities subject to the IPM requirements. Although the changes to the rules add "residential property" to the buildings and grounds subject to IPM requirements, it is our understanding from the Texas Department of Agriculture that this inclusion is intended to apply only to district-owned residential property that is primarily used as student housing. As requested by TDA, revisions include such residential property among the district facilities subject to the district's IPM program.

CMD(LEGAL) EQUIPMENT AND SUPPLIES MANAGEMENT: INSTRUCTIONAL MATERIALS CARE AND ACCOUNTING

An Administrative Code provision, effective June 7, 2022, has been added regarding purchasing technological equipment with the instructional materials and technology allotment.

Explanatory Notes

TASB Localized Policy Manual Update 121

Mineral Wells ISD

CNC(LEGAL) TRANSPORTATION MANAGEMENT: TRANSPORTATION SAFETY

Provisions have been added regarding the use of school bus warning signals.

CO(LEGAL) FOOD AND NUTRITION MANAGEMENT

New Administrative Code provisions were adopted regarding appeals related to federal food and nutrition programs administered by the Texas Department of Agriculture. A reference to these provisions, effective November 27, 2022, has been added.

CQ(LEGAL) TECHNOLOGY RESOURCES

A reference to Administrative Code provisions regarding management of electronic transactions and signed records has been clarified.

CQA(LEGAL) TECHNOLOGY RESOURCES: DISTRICT, CAMPUS, AND CLASSROOM WEBSITES

The link to the Texas Department of State Health Services Guidelines for the Care of Students with Food Allergies has been updated.

CRF(LOCAL) INSURANCE AND ANNUITIES MANAGEMENT: UNEMPLOYMENT INSURANCE

There are no significant revisions to the text on reasonable assurance; however, the policy template has been updated to accommodate the new adoption date function in Policy Online®. This policy is being issued at no charge to the district.

CSA(LEGAL) FACILITY STANDARDS: SAFETY AND SECURITY

The Commissioner of Education proposed new School Safety Requirements in the Commissioner's Rules Concerning School Facilities in November 2022. The public comment period closed December 12, 2022, but the rules are not yet finalized. The proposed rules require local policy provisions. Policy Service will include legal provisions in this new policy code and provide local policy provisions for consideration following publication of the final rules.

CVA(LOCAL) FACILITIES CONSTRUCTION: COMPETITIVE BIDDING

Policy BJA(LOCAL) authorizes the superintendent to delegate responsibilities to other employees of the district as permitted by law; thus, it is not necessary to include a reference to the superintendent's designee at Specifications. In addition, the policy template has been updated to accommodate the new adoption date function in Policy Online®. This policy is being issued at no charge to the district.

CVB(LOCAL) FACILITIES CONSTRUCTION: COMPETITIVE SEALED PROPOSALS

As noted above, policy BJA(LOCAL) authorizes the superintendent to delegate responsibilities to other employees of the district as permitted by law; thus, it is not necessary to include a reference to the superintendent's designee at Specifications. In addition, the policy template has been updated to accommodate the new adoption date function in Policy Online®. This policy is being issued at no charge to the district.

DBAA(LEGAL) EMPLOYMENT REQUIREMENTS AND RESTRICTIONS: PRE-EMPLOYMENT REVIEWS

Changes have been made to better reflect legal sources and to delete obsolete provisions.

Explanatory Notes

TASB Localized Policy Manual Update 121

Mineral Wells ISD

DEA(LOCAL) COMPENSATION AND BENEFITS: COMPENSATION PLAN

To eliminate the possibility of confusion about the frequency of pay, we recommend replacing *bimonthly* with the more specific and widely used *semi-monthly*. Other revisions are recommended for clarification and consistency with policy style.

The [Legal Issues in Update 121](#) memo describes common legal concerns and best practices specific to this policy's topic.

DEAB(LEGAL) COMPENSATION PLAN: WAGE AND HOUR LAWS

Changes have been made to better reflect legal sources.

E(LEGAL) INSTRUCTION

The E section table of contents has been updated to add the new code EHBCA, which includes provisions addressing accelerated instruction previously located at EHBC. The subtitle for policy EHBC has been changed to Compensatory Services and Intensive Programs.

EF(LEGAL) INSTRUCTIONAL RESOURCES

Legal definitions of "harmful materials" and "obscene" have been added for ease of access.

EHAD(LEGAL) BASIC INSTRUCTIONAL PROGRAM: ELECTIVE INSTRUCTION

A reference to Administrative Code provisions has been added regarding driver education safety program requirements.

EHBAB(LEGAL) SPECIAL EDUCATION: ARD COMMITTEE AND INDIVIDUALIZED EDUCATION PROGRAM

Changes reflect revised Administrative Code provisions regarding students who are homeless or in substitute care, effective January 1, 2023.

EHBAF(LEGAL) SPECIAL EDUCATION: VIDEO/AUDIO MONITORING

Revisions reflect amended Administrative Code provisions, effective January 22, 2023, pertaining to filing certain documents electronically.

EHBC(LEGAL) SPECIAL PROGRAMS: COMPENSATORY SERVICES AND INTENSIVE PROGRAMS

Update 121 includes a reorganization of the information regarding compensatory, intensive, and accelerated instructional services. Provisions addressing accelerated instruction have been moved to the new code EHBCA. The remaining provisions at this code, now subtitled Compensatory Services and Intensive Programs, have been reordered and adjusted for clarity.

EHBCA(LEGAL) COMPENSATORY SERVICES AND INTENSIVE PROGRAMS: ACCELERATED INSTRUCTION

This new policy addressing accelerated instruction comprises provisions moved from EHBC(LEGAL). For clarity, we have reordered and adjusted the material.

EHBH(LEGAL) SPECIAL PROGRAMS: OTHER SPECIAL POPULATIONS

An amended Administrative Code provision, effective January 18, 2023, has been added pertaining to regional day school programs for the deaf.

Explanatory Notes

TASB Localized Policy Manual Update 121

Mineral Wells ISD

EHBI(LEGAL) SPECIAL PROGRAMS: ADULT AND COMMUNITY EDUCATION

Changes reflect revisions to Administrative Code provisions, effective November 24, 2022, regarding essential program components of adult education programs.

EHBJ(LEGAL) SPECIAL PROGRAMS: INNOVATIVE AND MAGNET PROGRAMS

Changes include a new Administrative Code provision, effective February 26, 2023, regarding requests for approval of an innovative course by the State Board of Education.

EI(LEGAL) ACADEMIC ACHIEVEMENT

This legal policy has been revised to replace a repealed Administrative Code rule with a new rule, effective January 1, 2023, related to awarding credit to students who are homeless or in substitute care for coursework completed prior to the student enrolling in or transferring to the district. Other changes are to better reflect legal sources.

EKB(LEGAL) TESTING PROGRAMS: STATE ASSESSMENT

Duplicative text regarding students who fail to perform satisfactorily on a state assessment instrument has been deleted and replaced with a note pointing to EHBC and EHBCA.

FD(LEGAL) ADMISSIONS

The policy has been updated to delete an Administrative Code rule repealed by the State Board of Education, effective March 9, 2023.

FD(LOCAL) ADMISSIONS

Recommended revisions to this policy at Transition Assistance reflect the repeal and replacement of an Administrative Code provision regarding awarding credit to a student who is homeless or in substitute care. Under the new rule, a district must adopt a policy to ensure credit has been awarded appropriately prior to enrollment. Other changes provide greater flexibility for the district with regard to requiring proof of residency by removing specific requirements and referring to administrative regulations.

The *Legal Issues in Update 121* memo describes common legal concerns and best practices specific to this policy's topic.

FDA(LEGAL) ADMISSIONS: INTERDISTRICT TRANSFERS

This policy has been reorganized for clarity. Other changes are to better match statutory wording. Notes have been added to more clearly indicate the application of certain provisions.

FDC(LEGAL) ADMISSIONS: HOMELESS STUDENTS

A note has been added to clarify that information regarding support services for students experiencing homelessness, including provisions regarding district liaisons and transition services, is located at FFC.

FEA(LEGAL) ATTENDANCE: COMPULSORY ATTENDANCE

This legal policy has been updated to remove provisions of Administrative Code rules repealed by the State Board of Education, effective March 9, 2023. A note has been added referring to the *Student Attendance Accounting Handbook* for additional guidance.

FEB(LEGAL) ATTENDANCE: ATTENDANCE ACCOUNTING

This legal policy has been updated to remove provisions of Administrative Code rules repealed by the State Board of Education, effective March 9, 2023. We have also added a note referring to the *Student*

Explanatory Notes

TASB Localized Policy Manual Update 121

Mineral Wells ISD

Attendance Accounting Handbook for additional guidance, as well as existing statutory provisions for completeness and clarification.

FFAF(LLEGAL) WELLNESS AND HEALTH SERVICES: CARE PLANS

Links to the Texas Department of State Health Services' guidance for the care of students with diabetes and of students with food allergies have been updated.

FFC(LLEGAL) STUDENT WELFARE: STUDENT SUPPORT SERVICES

Revisions throughout this policy reflect amended Administrative Code provisions, effective January 1, 2023, regarding transition assistance for students experiencing homelessness or in substitute care.

FFI(LLEGAL) STUDENT WELFARE: FREEDOM FROM BULLYING

A note has been added with a link to the [Minimum Standards for Bullying Prevention](#) finalized by TEA on January 31, 2023.

FFI(LOCAL) STUDENT WELFARE: FREEDOM FROM BULLYING

The [Minimum Standards for Bullying Prevention](#), completed by TEA on January 31, 2023, include a requirement for policy provisions on reporting bullying incidents. Existing policy language addresses reporting by students and staff. The enclosed revisions are recommended to address the new minimum standards.

FL(LLEGAL) STUDENT RECORDS

Provisions at Access, Disclosure, and Amendment, beginning on page 4, have been revised and reorganized for clarity and to better reflect legal sources. The definition of eligible student has been added. Additional reporting requirements under the National School Lunch Act or the Child Nutrition Act have also been added. A note has been added at the beginning of the policy to clarify that information regarding juvenile law enforcement records is located in GBA.

G(LLEGAL) COMMUNITY AND GOVERNMENTAL RELATIONS

The G section table of contents has been revised to reflect the correct subtitle for GBA, Access to Public Information.

GB(LLEGAL) PUBLIC INFORMATION PROGRAM

Update 121 includes a reorganization of the public information policies in the GB series. As part of the reorganization, we have deleted provisions that are duplicated at other policy codes and adjusted provisions for clarity and to better match statutory wording.

GBA(LLEGAL) PUBLIC INFORMATION PROGRAM: ACCESS TO PUBLIC INFORMATION

As part of the reorganization of the public information policies, we have made the following changes:

- Deleted provisions that are duplicated at other policy codes and added cross-references, if necessary, to improve usability.
- Moved provisions regarding confidentiality based on statutes outside the Public Information Act (Government Code Chapter 552) to the policy code addressing the specific topic.
- Reordered and adjusted provisions for clarity and to better match statutory wording.

Explanatory Notes
TASB Localized Policy Manual Update 121

Mineral Wells ISD

GBAA(LLEGAL)

ACCESS TO PUBLIC INFORMATION: REQUESTS FOR INFORMATION

As part of the reorganization of the GB series, we have made the following changes:

- Deleted provisions that are duplicated at other policy codes and added cross-references, if necessary.
- Reordered and adjusted provisions for clarity and to better match statutory wording.

GRA(LLEGAL)

RELATIONS WITH GOVERNMENTAL ENTITIES: STATE AND LOCAL GOVERNMENTAL AUTHORITIES

This policy has been revised to include an Education Code provision prohibiting citation of a student alleged to have committed a school offense. Family Code definitions have also been added to support existing content regarding students taken into custody.



BOARD OF TRUSTEES Agenda Item

MEETING DATE: 6/12/23

MEETING TYPE:

- Regular Meeting
- Special Meeting

AGENDA ITEM TYPE:

- Action Item
- Non-Action Item

BOARD GOALS (check all that apply)

Academic Goals

- Academic Competitiveness
 - Early Literacy (HB3)
 - Early Math (HB3)
 - Other
- Career Certifications (HB3)

Operational Goals

- Promote Community/School Partnerships
- Fiscal Responsibility
- Safe and Secure Schools

TITLE: Discuss, consider, and take any necessary action regarding authorizing the superintendent to take all actions necessary for ensuring the installation or construction of a replacement portable classroom for Travis Elementary.

RECOMMENDED ACTION: It is recommended that the school board authorize the superintendent to take all actions necessary to ensure the installation of a replacement portable classroom at Travis Elementary.

BOARD POLICY/STATE REGULATION/LAW REFERENCE (if applicable): Gov't Code 2269, CV (LEGAL), CV (LOCAL), CVA (LEGAL), CVA (LOCAL), CVB (LEGAL), CVB (LOCAL), CVC (LEGAL), CVD (LEGAL), CVE (LEGAL), CVF (LEGAL)



OVERVIEW:

The board has authority under Government Code Chapter 2269 to enter into contracts for the delivery of construction projects. MWISD Board Policy Code CV (LEGAL) permits the school board to delegate its authority under Government Code Chapter 2269 to a designated representative, which could include the district superintendent. With such delegation, the superintendent would be authorized to enter into a contract with a portable building manufacturer, installer, and any other entities required to ensure proper installation and adherence to all policy requirements. All bidding and purchasing requirements would still be in effect if this is delegated to the superintendent or if it is not. The board also has the right to delegate this task to a representative and establish a spending limit.

FISCAL IMPACT: \$101,286.00

ATTACHMENTS: Bid documents

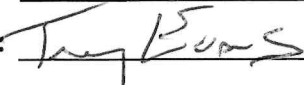
DEPARTMENT(S) SUBMITTING FORM: Maintenance

DEPARTMENT SIGNATURE/APPROVAL:  

Portable

Recommend Ram-Tech for \$101,286

Additional Cost

Demolition can be done in house and will cost approximately \$5000.

Fence Repair and Fire system make ready will not exceed \$6000.



AMERICA'S LEADER IN
DESIGN-BUILD
MODULAR CONSTRUCTION

May 23, 2023

Via e-mail: tevens@mwisd.net

Mr. Trey Evans
MINERAL WELLS I.S.D.
Mineral Wells, TX

Re: Proposal New Portable Classroom Buildings

Mr. Evans:

Ramtech Building Systems appreciates your continued interest and the opportunity to provide Mineral Wells ISD with a proposal for portable classroom buildings. The BuyBoard (Contract #637-21) price is based on a new commercial grade, state approved buildings constructed to the attached floor plan.

24'x64' Double Classroom without Restrooms: **\$101,286.00** per bldg.

Optional:

Treated wood 7'x14' wood landing with 4'x30' ramp: Add: \$6,97500.00 per assembly

Note: Cost is based on a maximum of 30" finish floor elevation above grade.

Pricing Includes:

- Delivery & Installation - Mineral Wells, TX
- C.M.U. block pad on grade foundation
- Auger type tie-downs (additional cost will be incurred for buildings set on asphalt due to anchoring requirements)
- Metal exterior and roof
- Skirting to grade on all sides
- Lay-in acoustical ceiling
- Vinyl covered gypsum wall panels
- Carpet flooring
- Marker - tack boards each classroom
- Interior communication door
- Exterior wall hung HVAC
- Main Distribution Panel
- State approved engineered drawings



AMERICA'S LEADER IN
DESIGN-BUILD
MODULAR CONSTRUCTION

Page 2 of 3 - Proposal New Portable Classroom Buildings

Pricing does not include:

- Site preparation (including grading, compaction or demolition, landscaping, or irrigation)
- Building permits (Any fees charged by the city or county agencies for the movement of mobile office or modular buildings over local roads are considered as part of the local building permit cost.)
- Furniture, mini-blinds, etc.
- Canopies
- Fire extinguishers/fire alarm/sprinkler system
- Landing and ramp assemblies (quoted as an additional cost)
- Performance and payment bond
- Permanent foundation
- Poured concrete
- Ramtech's Builders Risk Insurance excludes flood coverage in Flood Zones A, V, or D as defined by FEMA
- Taxes if applicable
- Waxing or sealing of vct flooring
- Utility extension/connections
- Wind certification (may be required in coastal areas designated as catastrophe areas)
- The scope of this design does not include accessibility elements required for the site. It is the owner's responsibility to have these designs developed and to make submittal as required by the Texas Architectural Barriers Act, through their design professional. This submittal should be made to: Texas Department of Licensing and Regulations, Architectural Barriers Section, P.O. Box 12157, Austin, TX 78711.

I will contact you to discuss any questions you might have or please feel free to contact me via email at squeen@ramtechgroup.com or by calling 800-568-9376 ext. 138.

Sincerely,
Sabrina Queen
Education Representative

Note: Given the volatility of material prices and supply chain challenges, Ramtech's price is valid for Tuesday June 13, 2023. Please contact Ramtech prior to issuance of a p.o. to verify available production openings and scheduling.

All pricing is based on a level, accessible site.



AMERICA'S LEADER IN
DESIGN-BUILD
MODULAR CONSTRUCTION

Page 3 of 3 - Proposal New Portable Classroom Buildings

Freight, setup, and other finish-out scopes are priced based on Ramtech's ability to manufacture the building in Q3, Q4 2023, and deliver and complete the project in a timely manner thereafter. Should any unforeseen delay occur in the permitting or site work process, or due to any other cause outside of Ramtech's control, these scopes may need to be repriced and a Change Order executed prior to building delivery.

Ramtech has quoted the pricing reflected in this proposal as competitively as possible. As such, once we begin, we have anticipated an uninterrupted flow of our work through the completion of the project. Should non-weather-related events beyond Ramtech's control, such as delays in electrical or water service to the building, force us to demobilize and subsequently remobilize at a later date, additional costs will be incurred that may be passed on to our customers.

Standard payment terms are 25% upon issuance of p.o., 70% prior to delivery and installation, 5% on completion and acceptance.

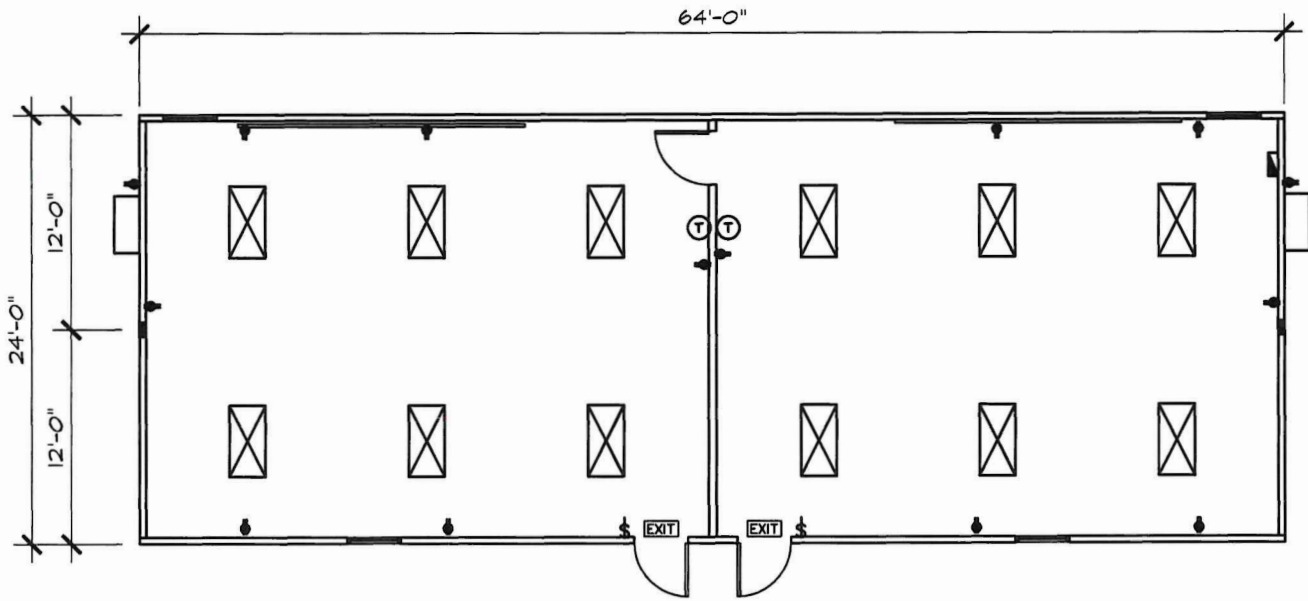

FLOOR PLAN

RT-02

- ☒ 2X4 CEILING MT. FLUORESENT LIGHT
- ☒ SINGLE POLE SWITCH @ 48"A.F.F.
- ☒ 24X24 CEILING MT. ADJ. SUPPLY AIR DIFFUSER
- EXIT CEILING MT. EXIT LIGHT W/BATTERY PACK
- ☒ CEILING MT. LIGHT/EXHAUST FAN
- ☒ CEILING MT. 24X24 RETURN AIR GRILLE
- ⊕ 110V DUPLEX RECEPTACLE @ 15"A.F.F.
- ⊕ PROGRAMMABLE THERMOSTAT @ 54"A.F.F.
- ⊕ 110V 6FI DUPLEX RECEPT. @ 15"A.F.F.

DATE		DRAWN		CHECKED		APPROVED	
PORTABLE DOUBLE CLASSROOM BLDG.							
PURCHASE ONLY							

Ramtech RT Portable Classroom

Schools all across the SouthWest

Project Size
1536 sq ft

Facility Use
Portable Classroom

Description
Vinyl covered gypsum interior
Wall-hung HVAC units
Metal exterior & roof

Completion
About 30 days

Temporary Modular Construction

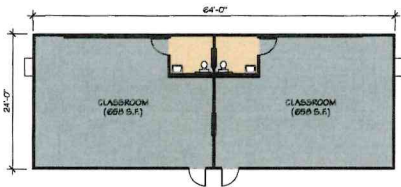

RAMTECH Building Systems
CLA-1536-A 1536 Sq Ft. DOUBLE CLASSROOM BLDG. with RESTROOMS



In 1982 Ramtech pioneered the concept of building all-modular portable classrooms and relocatable modular buildings that have now been in use by hundreds of public, private, and faith-based schools throughout the Southwest. The Ramtech RT (sale) and LT (lease) series portable classrooms, available with and without restrooms, are the largest selling portable classroom in Texas. At 1,536 square feet, each Ramtech double classroom building includes two three-ton wall-hung HVAC units, carpet or tile flooring, vinyl covered gypsum interiors, and marker boards. All Ramtech portable classrooms are available for sale or lease through the Texas Buy-board, TIPS (The Interlocal Purchasing System) and HGACBuy (Houston Galveston Area Council) purchasing cooperatives.

RAMTECH
Building Systems
800-568-9376
ramtechmodular.com

LIMITED WARRANTY

NEW BUILDING

Ramtech Building Systems, Inc. warrants for a period of one (1) year from the date of occupancy to purchaser that each building will be free from defects in material and workmanship under normal use and service. This warranty does not cover items such as heater, air conditioner, water heater, tires, and other components which are purchased by Ramtech from recognized manufacturers and carry their own warranty, nor does it cover any building that has been subjected to misuse, neglect, or accident.

Should any failure to conform with the foregoing warranty appear within such one (1) year period, Ramtech will, at its option, either repair or replace the defective part, F.O.B. Ramtech's factory or such other place as may be mutually agreed upon in writing by Ramtech and Purchaser. The remedy herein provided is Ramtech's only obligation and the sole exclusive remedy for failure by Ramtech to conform to the foregoing warranty. In no event shall Ramtech be liable for incidental or consequential damages, including by way of illustration and not limitation, loss of profits and loss of other property or equipment, unless such damages are for personal injury.

ALL WARRANTY REPAIRS MUST BE AUTHORIZED BY RAMTECH BUILDING SYSTEMS, INC., who will replace or repair free to charge (including related labor) any defective part covered by this warranty about which the Purchaser shall have notified Ramtech Building Systems, Inc. in writing within the warranty period. Ramtech Building Systems, Inc. does acknowledge its responsibility of making warranty repairs within a reasonable period of time after being advised by Purchaser on the details of any deficiencies. UNAUTHORIZED WARRANTY CHARGEBACKS OR CLAIMS WILL NOT BE HONORED BY RAMTECH BUILDING SYSTEMS, INC.

Ramtech Building Systems, Inc. will assume no expense or responsibility for the cost of any repairs if Ramtech Building Systems, Inc. is not notified in advance of the need for such repairs and if Ramtech Building Systems, Inc. is not given the opportunity to perform such repairs with its own forces or to otherwise manage complete correction of the problem.

The foregoing warranty is expressly in lieu of all other warranties, whether expressed or implied, including but not limited to, the implied warranties of merchantability and fitness for a particular purpose.

* This warranty no longer remains in effect if the building is exported from the continental United States, anytime during the one (1) year warranty period.

BID SPECIFICATIONS (PURCHASE ONLY)

BuyBoard – Proposal 637-21

Contract Period March 1, 2021 through February 28, 2022 With Two (2) Possible One (1) Year Renewals

RT 01 & RT-02 PORTABLE DOUBLE CLASSROOM WITH AND WITHOUT RESTROOMS

24'-0" x 64'-0"

VARIOUS SITES WITHIN 600 MILES OF ORIGIN

1.0 FLOOR

- 1.1 BOTTOM BOARD:** 12 mil, GW Polymax one piece rolled continuous construction fabric.
- 1.2 INSULATION:** R-30 Kraft faced fiberglass batts.
- 1.3 JOISTS:** 2x10 #2 SYP installed transverse at 16" o.c.
- 1.4 PERIMETER RAILS:** Double 2x10 #2 SYP on all sides/splice blocks mating lines only.
- 1.5 DECKING:** Single layer 3/4" tongue and groove plywood installed perpendicular to floor joists.
Hold back decking 2" each side of mateline and install 4" piece on site.
- 1.6 FLOOR COVERING:** 26 oz., olefin, solution dyed, level loop pile, polypropylene back, direct glue down, commercial carpet installed in Classrooms. Color shall be Brown.
12" x 12" x 1/8" Vinyl composition tile shall be plant installed in restrooms, if applicable.
Color shall be: Armstrong Excelon #51858 Sandrift White or equal.

2.0 EXTERIOR WALLS

- 2.1 TYPE:** IBC framing.
- 2.2 STUDS:** 2x6 #2 SYP at 24" o.c. 2 belt rail DADOES shall be provided for sidewall studs only.
- 2.3 BOTTOM PLATE:** Single 2x6 #2 SYP.
- 2.4 TOP PLATE:** Double 2x6 #2 SYP.
- 2.5 WALL HEIGHT:** Refer to prints.
- 2.6 INTERIOR FINISH:** 5/8" Type "X" vinyl covered gypsum installed over 7/16" OSB sheathing. VCG shall be Ruff Stuff Frost.
Hold back VCG each side of mateline approximately 12"-16". VCG for these areas shall be shipped loose for site installation.
- 2.7 INSULATION:** R-19 Un-faced fiberglass batts to roof.
- 2.8 SHEATHING:** 15# felt around windows/doors only, extend to floor, overlap bottom board.
A water resistant barrier shall be installed full height, full perimeter of the exterior.
7/16" OSB sheathing shall be installed full height on the interior face of the exterior wall framing.
- 2.9 SIDING:** 26 Gauge, high rib commercial steel siding with "R panel" profile and baked enamel finish. Color shall be: Light Stone.
- 2.10 TRIM:** 26 gauge "Z" bottom trim. Color to be Light Stone.
26 gauge "J" trim around window & doors. Color to be Light Stone.

BID SPECIFICATIONS (PURCHASE ONLY)

BuyBoard – Proposal 637-21

Contract Period March 1, 2021 through February 28, 2022 With Two (2) Possible One (1) Year Renewals

RT 01 & RT-02 PORTABLE DOUBLE CLASSROOM WITH AND WITHOUT RESTROOMS

24'-0" x 64'-0"

VARIOUS SITES WITHIN 600 MILES OF ORIGIN

- 2.11 FASCIA/GUTTER:** 26 Gauge steel gutter front side only. Water diverters shall be installed at each end. Remainder of roof shall receive fascia/rake trim. Color to be Cocoa Brown.
- 2.12 TIE DOWNS:** Jack stud hurricane straps and earth anchors per print.
- 2.13 SKIRTING:** Same material as used for exterior siding installed to grade with perforated venting panels and crawl space access panel.

3.0 INTERIOR WALLS

- 3.1 STUDS:** 2x4 #2 SYP at 16" o.c. (Refer to prints for sizing and spacing of plumbing wall.)
- 3.2 BOTTOM PLATE:** Single 2x4 #2 SYP.
- 3.3 TOP PLATE:** Double 2x4 #2 SYP.
- 3.4 HEADERS:** Double 2x4 #2 SYP on edge with 1/2" CDX plywood filler.
- 3.5 WALL HEIGHT:** 8'-1-1/2".
- 3.6 FINISH:** 5/8" Type "X" Vinyl covered gypsum wall board.
VCG shall be Ruff Stuff Frost or equal.
Building with Restrooms only, the wall directly opposite the water closets and lavatories shall receive VCG as described above. The three remaining walls in each restroom shall receive full height Class "C" FRP (fiberglass reinforced panels) installed over 5/8" type "X" moisture resistant gypsum. FRP shall be white.
- 3.7 INSULATION:** R-11 (3-1/2") unfaced fiberglass batts.

4.0 MOULDING

- 4.1 BASE:** 4" Vinyl cove base throughout.
Color shall be Dark Brown.
Base shall be plant installed.
- 4.2 VERTICAL:** 1-1/2" Pre-finished vinyl wrapped nail on battens on all seams.
- 4.3 WINDOWS:** 1-1/2" Pre-finished white waterfall. The jambs of all windows shall be finished the same as the walls.

5.0 ROOF

- 5.1 RAFTERS:** 2x8 #2 SYP installed at 24" o.c. Rafters shall be installed so as to provide a 2 in 12 pitch.
- 5.2 RIDGE GIRDER:** Pre-engineered single 3-1/2" wood girder each side of the mate line.
- 5.3 BRIDGING:** 1-1/2" steel angle installed at 8' o.c. from truss to rafter.
- 5.4 CEILING:** 2' x 4' x 5/8" Acoustical mineral fiber in suspended T-grid system. Ceiling tiles shall be USG #2410 or equal. Ceiling shall be installed at the factory or in the field.

BID SPECIFICATIONS (PURCHASE ONLY)

BuyBoard – Proposal 637-21

Contract Period March 1, 2021 through February 28, 2022 With Two (2) Possible One (1) Year Renewals

RT 01 & RT-02 PORTABLE DOUBLE CLASSROOM WITH AND WITHOUT RESTROOMS

24'-0" x 64'-0"

VARIOUS SITES WITHIN 600 MILES OF ORIGIN

- 5.5 CEILING HEIGHT:** The finished ceiling height throughout the building shall be 7'-10".
- 5.6 INSULATION:** R-30 Un-faced fiberglass batts installed between joists. Insulation shall be held in place with nylon mesh.
- 5.7 SHEATHING:** 7/16" OSB or 1/2" CDX plywood installed perpendicular to the roof joists.
- 5.8 ROOFING:** 29 Gauge, high rib commercial steel roofing panels with R-profile and Galvalume finish, installed over one layer of 15# felt.
- 5.9 ROOF VENTS:** Barometric relief damper as indicated on the plans.

6.0 EXTERIOR DOORS

- 6.1 DOORS:** 1-3/4" x 36" x 80", 18 Gauge hollow core commercial steel. Doors to have minimum U-Value of 0.70.
- 6.2 FRAMES:** Steel doors shall be equipped with 16-gauge knockdown commercial steel frames.
- 6.3 HARDWARE:** All exterior doors shall be equipped with 1-1/2 pair of ball bearing, butt hinges, full weatherstrip, door sweep and threshold.
- 6.4 LOCKSETS:** All exterior doors shall be equipped with a keyed panic hardware with exterior lever handle pull; "Tell" or equal. Exterior doors shall be keyed alike; each building keyed separate.
- 6.5 CLOSER:** A hydraulic closer with back check feature shall be provided on all exterior doors; "Tell" or equal.
- 6.6 FINISH:** The interior and exterior side of the doors and frames shall be painted Cocoa Brown.

7.0 INTERIOR DOORS **With Restroom Option**

- 7.1 DOORS:** 1-3/4" X 36" X 80", Pre-finished solid core wood, Jeld-Wen Imperial Oak or equal.
- 7.2 FRAMES:** All interior doors shall be set in prefinished 20 ga. commercial steel frames with baked enamel finish; "Timely" or equal. Color shall be: Brown.
- 7.3 HARDWARE:** All interior doors shall be equipped with 1-1/2 Pr. 4-1/2"x4-1/2" mortise hinges US 26D Finish.
- 7.4 LATCHSETS:** "Tell" or equal lever handle latch with privacy function for restrooms and passage function for communicating door.

8.0 WINDOWS

- 8.1 TYPE:** (4) 36"x60" Egress type, vinyl framed, single hung, vertical slider, white finish frame, glazing shall be dual pane insulated low-e glass and window screen.
- Windows shall have a minimum U-Value of .55 and a SHGC of .25

9.0 ELECTRICAL

- 9.1 SERVICE:** 120/240v- Single phase- 3W- 60hz.

BID SPECIFICATIONS (PURCHASE ONLY)

BuyBoard – Proposal 637-21

Contract Period March 1, 2021 through February 28, 2022 With Two (2) Possible One (1) Year Renewals

**RT 01 & RT-02 PORTABLE DOUBLE CLASSROOM WITH AND WITHOUT RESTROOMS
24'-0" x 64'-0"**

VARIOUS SITES WITHIN 600 MILES OF ORIGIN

- 9.2 MAIN DISTRIBUTION PANEL:** 120/240v, single phase, indoor flush mount with 200 AMP main breaker.
- 9.3 BREAKERS:** All breakers shall be plug in type.
- 9.4 ENTRANCE:** 2" EMT conduit stubbed through exterior wall.
- 9.5 RACEWAY/ CONDUCTORS:** Minimum #12 AWG type THHN copper wire in concealed MC cable or EMT (electric metallic tubing) conduit.
- 9.6 LAY-IN LIGHTS:** 2'x4', 120v, recessed, LED lights with acrylic diffuser. Lights shall be plant wired and secured to the roof joists for shipment to the job site.
- 9.7 EXIT/EMERGENCY LIGHTS:** Combination 120 volt wall mount with back up battery power exit light with dual head emergency light. Exit lights shall be plant installed.
- 9.8 COMBO EXTERIOR LIGHT / EMERGENCY LIGHT:** 11 Watt high output LED, weather proof, bronze housing, with photo-cell and battery back-up for emergency egress. Light shall be installed between exterior doors. Weatherlite WLEM-BZ.
- 9.9 RESTROOM LIGHTS:** 60 Watt incandescent light/fan combination installed in each restroom, if applicable.
- 9.10 RECEPTACLES:** 120v, 20 AMP, duplex grounding type with matching plastic cover. Color shall be White. Exterior receptacles shall be GFCI protected with in-use cover.
- 10.11 SWITCHES:** 120v wall mounted switch/occupant sensor. Manual-on, auto-off. Color shall be White. Refer to plans. Leviton ODS10-IDW or equal.
- 10.0 PLUMBING** **Building with restrooms only.**
- 10.1 WATERLINES:** Water supply lines shall be CPVC or PEX with appropriate fittings. All fixtures shall be provided with shut-off valves.
- 10.2 WASTELINES:** PVC-DWW-SCH-40 drain, waste and vent lines.
- 10.3 WATERHEATER:** (1) EEMAX SP2412 120 volt/2.4KW instantaneous water heater.
- 10.4 WATER CLOSET:** White vitreous china tank type with open front seat and elongated bowl. Water closets shall be installed to meet TAS requirements.
- 10.5 LAVATORIES:** Vitreous china wall hung with 4" washerless center set. Lavatories shall be installed to meet TAS requirements.
- 10.6 ACCESSORIES:** Single roll toilet paper holder at each water closet. S.S. grab bars at each water closet in each restroom.

BID SPECIFICATIONS (PURCHASE ONLY)

BuyBoard – Proposal 637-21

Contract Period March 1, 2021 through February 28, 2022 With Two (2) Possible One (1) Year Renewals

RT 01 & RT-02 PORTABLE DOUBLE CLASSROOM WITH AND WITHOUT RESTROOMS

24'-0" x 64'-0"

VARIOUS SITES WITHIN 600 MILES OF ORIGIN

18"X36" metal edged mirror over each lavatory.

11.0 H.V.A.C.

- 11.1 PACKAGED:** (2) 36,000 B.T.U. 240v single phase wall hung H.V.A.C. system with fresh air intake damper. Bard or equal.
- 11.2 HEATING:** (1) 10 KW 240v electric resistance heat strip in each air conditioner.
- 11.3 SUPPLY:** Through a wall mounted grill located at each H.V.A.C. unit.
- 11.4 RETURN AIR:** Through a wall mounted grill located at each H.V.A.C. unit.
- 11.5 THERMOSTAT:** (1) Programmable thermostat shall be provided for each H.V.A.C. unit, Luxpro PSP511 or equal.
- 11.6 EXHAUST FANS:** (1) Combination 80 cfm exhaust fan/light fixture in each restroom.

12.0 CASEWORK **N/A.**

13.0 FURNISHINGS

- 13.1 TACKBOARDS:** Each classroom shall be equipped with (1) 4'-0" x 4'-0" Claridge #844For equal, tackboard with heavy duty satin finish aluminum frames.
- 13.2 MARKERBOARDS:** Each classroom shall be equipped with (2) 4'-0" x 8'-0" Claridge #MLC or equal, 2048 white marker boards with heavy duty satin finished, anodized aluminum frames and troughs.

14.0 DESIGN CRITERIA

- 14.1 FLOORS:** The floor systems shall be constructed to accommodate a live load of 50 lb/sft in addition to the dead loads.
- 14.2 WALLS:** The exterior walls shall be framed, braced and secured in accordance with the requirements of the IBC, based on 140 mile per hour wind loads, occupancy category II.
- 14.3 ROOFS:** All structural components of the roof system shall be designed and erected to span their respective areas and carry a live load of 20 lb/sft and a dead load of 10 lb/sft.
- 14.4 HEATING:** The heating system shall be designed to maintain an interior temperature of 72 degrees + or - 2 degrees.
- 14.5 COOLING:** The cooling system shall be designed to maintain an interior temperature of 75 degrees + or - 2 degrees.
- 14.6 CODES:** The building shall be built in accordance with the following codes.
- A. International Building Code, 2015
 - B. International Plumbing Code, 2015
 - C. International Mechanical Code, 2015
 - D. National Electrical Code, 2014
 - E. International Energy Conservation Code, 2015
 - F. Texas Accessibility Standards, 2012

BID SPECIFICATIONS (PURCHASE ONLY)

BuyBoard – Proposal 637-21

Contract Period March 1, 2021 through February 28, 2022 With Two (2) Possible One (1) Year Renewals

RT 01 & RT-02 PORTABLE DOUBLE CLASSROOM WITH AND WITHOUT RESTROOMS

24'-0" x 64'-0"

VARIOUS SITES WITHIN 600 MILES OF ORIGIN

14.7 APPROVALS: A. State of Texas Industrialized, Housing and Building Rules, as administered by the Texas Department of Licensing and Regulations.

15.0 FIELD ACTIVITIES

15.1 SITE PREPARATION: No provisions for site work has been included. The client is responsible for all clearing, grubbing, filling, backfilling, grading and associated compaction to achieve a uniform soil bearing capacity of 2500 PSF prior to delivery of the building units. In addition to the above, the site shall be uniformly level (+/-3") so a finished floor to grade elevation of a maximum 30" shall be present at all building entries and at the entry of the step and ramp assembly. The site shall have adequate drainage to provide a positive flow of storm water away from the building. Also storm water shall not pass under the building from any direction. The client is also responsible for providing clear access to the site. Clear access to the site is defined as the building pad being accessible for both the delivery truck and the building unit. Physical on site obstructions shall not prevent the delivery truck from being able to deliver the building unit to the pad site, detach from the building and depart the site.

15.2 ELECTRIC UTILITIES: The client will be responsible for bringing electrical service to the building and making final connection. The Contractor will provide a stub out from the main distribution panel that allows for a single point of connection by the client. The meter base and weather head shall be provided by the client.

15.3 WATER UTILITIES: The client will be responsible for bringing the fresh water service to the building and making the final connection, if applicable.

15.4 SEWER UTILITIES: The client will be responsible for bringing the sewer line to the building, providing and installing the drain, waste and vent manifold to the contractors supplied sewer and vent drops which are through the floor, if applicable.

15.5 FOUNDATION Piers shall be installed down each side and matelines at maximum 8'-0" o.c. and at column locations. Piers shall consist of "dry" stacked hollow cell CMU blocks installed on 16" x 16" ABS pad or 4"x16"x16" precast concrete pad. Each building shall be securely anchored to the ground using auger type anchors, quantity of anchors required shall be based on wind load of the installation site.

EXCLUSIONS:

Taxes

Performance and Payment Bonds

Building Permits

Surveys

Civil Design

Entry Assemblies

BID SPECIFICATIONS (PURCHASE ONLY)

BuyBoard – Proposal 637-21

Contract Period March 1, 2021 through February 28, 2022 With Two (2) Possible One (1) Year Renewals

RT 01 & RT-02 PORTABLE DOUBLE CLASSROOM WITH AND WITHOUT RESTROOMS

24'-0" x 64'-0"

VARIOUS SITES WITHIN 600 MILES OF ORIGIN

Soils Testing/Analysis

Site Development

Utility Extensions/Connections

Plumbing Manifold

Landscaping or Irrigation

Poured Concrete

Texas Department of Insurance Wind Storm Compliance/Certification

Storm Shelter

Fire Alarm

Fire Sprinkler

TAS Submittal

TAS Compliance for Accessible Routes Beyond the Building's Footprint.

Builders Risk Insurance excludes flood coverage in Flood Zones A, V or D as defined by FEMA.

16.0 OPTIONS (SEE OPTIONS PRICING SCHEDULE)

16.1 HARDI-PANEL SIDING:

Provide Hardi-Panel siding in-lieu of 26 Ga. steel siding. Hardi-Panel siding shall be installed over 3/8" CDX plywood or 7/16" OSB, Tyvek House Wrap and 15# Felt paper. Hardi-Panel shall be finished with two coats of Elastomeric paint. 4" trim shall be installed on corners, around doors and windows. 26 GA. steel rake trim on ends and gutter with downspouts shall be installed on each eave side. Skirting shall be Hardi-Panel.

16.2 SMART PANEL SIDING:

Provide Smart Panel siding in-lieu of 26 Ga. steel siding. Smart Panel siding shall have vertical groves at 8" o.c. and be installed over 15# Felt paper. Smart Side siding shall be finished with two coats of exterior Latex paint. 4" trim shall be installed on corners, around doors and windows. 26 GA. steel rake trim on ends and gutter with downspouts shall be installed on each eave side. Skirting shall be Smart Panel siding.

16.3 ENTRY ASSEMBLIES:

A landing and ramp assembly shall be provided at the exterior doors. The landing shall consist of a minimum 6'x12' platform. The ramp shall be constructed approximately 48" wide x 30' in length with a minimum slope not to exceed 1/12. Complete assembly is based on maximum of 30" finish floor elevation above grade. All landings and ramps are to be provided with handrails equipped with horizontal rails at a maximum 4" spacing. The platform ramps and handrails are to be constructed of pressure treated lumber, ACQ or equal. Construction shall follow Ramtech standard entry assembly drawings, i.e. post base pads set on existing grade, etc.

Handrails shall be smooth and free of splinters at the time of installation.

BID SPECIFICATIONS (PURCHASE ONLY)

BuyBoard – Proposal 637-21

Contract Period March 1, 2021 through February 28, 2022 With Two (2) Possible One (1) Year Renewals

RT 01 & RT-02 PORTABLE DOUBLE CLASSROOM WITH AND WITHOUT RESTROOMS

24'-0" x 64'-0"

VARIOUS SITES WITHIN 600 MILES OF ORIGIN

Note: Pricing schedule reflects standard entry assemblies constructed per above specifications. If local jurisdiction requires buried concrete pads, poured concrete footers or additional structural elements this additional cost would be included as a change order to the Client.



505 North I-35 East, DeSoto, Texas 75115 P 469.727.0727 F 469.727.0728 866.912.4587 www.palomarmodularbuildings.com

April 12, 2023

Trey Evans
Mineral Wells ISD
Mineral Wells, TX

Thank you for your interest in Palomar Modular Building LLC. The price reflected below, a new 24' x 64' Dry Classroom building (nominal dimensions), manufactured, delivered, and set in Mineral Wells, TX is based on the attached specifications and Floor plan.

1. The purchase price as specified for the dry is \$105,825. This price is for a new building that is in our current inventory. The purchase price does not include poured concrete footers, canopies, handicap ramps, steps, gutters, self-contained fire alarm, low voltage equipment, utility hookups, site work, taxes or permits. It is assumed that the site can support the building, is relatively level and easily accessible.
2. This price does not include poured concrete footers, canopies, handicap ramps, gutters, low voltage equipment, utility hookups, site work, sales tax, use tax or excise taxes or permits. It is assumed that the site can support the building, is relatively level and easily accessible.
3. The building will be built in compliance with the International Building, Plumbing and mechanical codes, Americans with Disabilities Act, and the National Electric Code. The building will be engineered to meet local floor and roof load requirements and will have electrical, heating and cooling loads sized in accordance with code. Cost to comply with local codes beyond the attached floor plan and specifications is the responsibility of the owner.
4. ***Due to the volatility in lumber and other commodity markets we can only honor prices for 30 days.***
5. Our payment terms are 50% due upon execution on PO or Contract, 40% due upon completion of manufacturing at PMB and 10% when the building is accepted or occupied, whichever comes first.

Sincerely,

Jane Tavern
Business Developer
Palomar Modular Buildings LLC
469-727-0727 (o)
214.546.2843 (c)

SPECIFICATION AND STATEMENT OF WORK			
CUSTOMER	MINERAL WELLS ISD	LAYOUT	24' X 64' NOMINAL
DESTINATION	MINERAL WELLS, TX	SIZE	1,516
BUILDING TYPE	VB	# OF MODS	2
DATE	4/12/2023	CODES	2015 IBC, IPC, IMC, IECC, 2014 NEC, 2012 TAS
CONSTR TYPE / USE:	EDUCATION		
FLOORS			
FRAME TYPE	OUTRIGGER SIZED TO MEET DESIGN CRITERIA		
RUNNING GEAR	TIRES, AXLES AND HITCHES REMOVED AND STORED UNDER UNIT, IF BUILDING IS SET LOWER THAN 34" AFG HITCH TO BE LEFT OUTSIDE BUILDING LINE.		
WOOD JOISTS	2X10 SYP @ 16 OC		
INSULATION	R-30 FIBERGLASS UNFACED FIBERGLASS BATT		
DECKING	3/4" STURDI-FLOOR T&G		
MOISTURE PROTECTION	"BOTTOM BOARD" WOVEN, REINFORCED POLY		
FLOOR COVERING	12 IN COMMERCIAL VINYL TILE		
	LOCATION	T/O	
COVE BASE	4 IN VINYL		
EXT. WALLS			
INSULATION	R-19 FIBERGLASS UNFACED FIBERGLASS BATT		
EXTERIOR SHEATHING	7/16" OSB		
MOISTURE CONTROL	BUILDING WRAP		
EXTERIOR SIDING	29 GA STEEL PRE-FINISHED, PANEL LOC +		
VINYL GYP WALL FINISH	5/8" VINYL COVERED GYP (VENETIAN FROST)		
INT. WALLS			
WOOD STUDS	2X4 @ 16 O.C. WITH DOUBLE TOP AND SINGLE BOTTOM PLATES		
INSULATION	R-11 UNFACED		
VCG WALL FINISH	5/8" VINYL COVERED GYP (VENETIAN FROST)		
CLASS "C" FRP	FULL HEIGHT		
	LOCATION	RESTROOM	
ROOF			
TYPE	WOOD WITH LAMINATED PLYWOOD MATE BEAMS		
STD. WOOD RAFTERS	2X10 @ 24 OC		
INSULATION	R-30, UNFACED		
DECKING	7/16" OSB		
FELT OR SLIP SHEET	YES		
METAL ROOF COVERING	29 GA GALVALUME ROOF PANEL-LOC + OVER 1 LAYER 15# FELT		
CEILING	2X4 SUSPENDED CEILING, USG RADAR TILE, 15/16 GRID		
DOORS			
EXTERIOR STEEL DOORS	3-0 / 6-8 STEEL DOOR, KNOCK DOWN FRAME, CLOSER, PAINTED 18GA DOOR, 16GA FRAME, INSULATED		
INTERIOR DOORS	3-0 / 6-8 PRE FINISHED SOLID CORE WOOD DOOR / 18GA "TIMELY" KNOCK DOWN STEEL FRAME		
DOOR GLAZING	DOOR GLASS: 6X27" (EXT)		
EXT DOOR HARDWARE	PMB STANDARD LEVER/PANIC GRADE 2		
INT DOOR HARDWARE	LEVER-PRIVACY: GRADE 2, PMB STANDARD		
DOOR STOPS	FLOOR MOUNTED		
WINDOWS			
EXTERIOR WINDOWS	3-0 / 4-0 DUAL PANE, LOW E, CLEAR GLAZING, SINGLE HUNG ALUMINUM FRAME (SERIES 100)		
BLINDS	1" METAL MINI BLINDS		
ELECTRICAL			
CONDUIT	NON-METALLIC TUBING (ENT)		
RECEPTACLES	DUPLEX RECEPTACLES, 20 AMP, UNBREAKABLE COVERS		
EXTERIOR RECEPTACLE	CONVENIENCE DUPLEX WITH COVER		
DEDICATED RECEPTACLES	20A - 30A CONNECTION (30 GAL OR SMALLER WATER HEATER)		
PANELS	100A-200A, 10KAIC, 1P, CLIP ON BREAKERS		
ROOM LIGHTING	2X4 LED FIXTURE		
EMERGENCY LIGHTS	EMERGENCY - 2 BULB LED WITH REMOTE HEAD		
EXIT LIGHTS	EXIT LIGHTS, LED W/BATTERY BU		
EXTERIOR LIGHTS	EXTERIOR PORCH, LED AT EACH EXIT		
OCC. SENSOR, SINGLE	PER CODE		
EMPTY BOX & CONDUITS	STUBBED TO CEILING, 3/4"		
FIRE PROTECTION			
NIC			
HVAC			
STD. UNITS	WALL MOUNTED PACKAGED HVAC WITH ELECTRIC HEAT STRIP, 1 PHASE, SIZED PER DESIGN REQUIREMENTS		
SUPPLY AIR	DUCTED		
DUCTING	FLEX DUCT		
RETURN AIR	AT RETURN, JUMP DUCTS AS REQUIRED		

THERMOSTATS	7 DAY PROGRAMABLE WITH OCCUPANT OVERRIDE
DIFFUSERS	ADJUSTABLE DIFFUSERS
FILTER	AT UNIT
EXHAUST FANS	80 CFM EXHAUST FAN/LIGHT COMBO
MILLWORK & BLOCKING	
NONE	
MISC. & ACCESSORIES	
NONE	
SHIP LOOSE	
CLOSE UP	CLOSE-UP PLASTIC FOR SKIRTING OR BELLY BAND
SKIRT FRAMING	PRESSURE TREATED WOOD FRAMING (36" HT)
SKIRTING	29 GA METAL
SET UP	ANCHORS, AUGER, STRAPS, CLIPS
SET UP	2" X 8" PT SHIMS & OAK WEDGES
NOTES	
NONE	
SITE WORK	
<i>DELIVERY, SET AND SKIRT</i>	
PALOMAR MODULAR BUILDINGS (PMB)	
CLARIFICATIONS	
<p>ALL MATERIALS AND EQUIPMENT PROVIDED FOR THE CONSTRUCTION OF THIS PROPOSED PROJECT WILL BE OF TYPICAL QUALITY AND DURABILITY FOR SIMILAR TYPES OF CONSTRUCTION. ANY MATERIALS LISTED WITH SPECIFIC NAME BRANDS MAY BE SUBSTITUTED FOR OTHER BRANDS OF COMPARABLE QUALITY.</p> <p>PALOMAR MODULAR BUILDINGS (PMB) MANAGEMENT'S PROPOSAL IS BASED ON THESE WRITTEN SPECIFICATIONS AND STATEMENT OF WORK PROVIDED</p> <p>CUSTOMER IS RESPONSIBLE FOR ALL PERMITS INCLUDING BUILDING PERMITS, LICENSING COSTS AND IMPACT FEES. PMB WILL BE RESPONSIBLE FOR ALL PERMITS REQUIRED FOR TRANSPORTATION OF THE MODULES OVER THE ROAD.</p> <p>BUILDING FOOTPRINT NEEDS TO BE WITHIN 12" OF LEVEL IN A 60' SPAN</p> <p>CUSTOMER WILL PROVIDE AN APPROPRIATE GRADED AND COMPACTED SITE AS REQUIRED FOR THE SETTING OF THE MODULAR BUILDING. GRADING SHOULD PROVIDE POSITIVE DRAINAGE AWAY FROM THE BUILDING AND COMPACTION TO A MINIMUM ALLOWABLE SOIL BEARING PRESSURE OF 2000 PSF. IT IS ASSUMED THAT THE MODULAR BUILDING WILL BE SET ABOVE GRADE. PMB WILL UTILIZE ABS PADS AND STACKED CMU BLOCK PIERS TO SET THE BUILDING ON GRADE.</p> <p>FINISHED FLOOR WILL BE BETWEEN 34" AND 38" ABOVE GRADE</p> <p>CUSTOMER WILL PROVIDE SITE ACCESSIBILITY FOR STANDARD MODULAR INDUSTRY DELIVERY AND INSTALLATION VEHICLES</p> <p>PRICES ARE VALID FOR 30 DAYS.</p> <p>THE BUILDING WILL BE BUILT IN COMPLIANCE WITH THE INTERNATIONAL BUILDING CODE, AMERICANS WITH DISABILITIES ACT, AND THE NATIONAL ELECTRIC CODE. THE BUILDING WILL BE ENGINEERED TO MEET LOCAL FLOOR AND ROOF LOAD REQUIREMENTS AND WILL HAVE ELECTRICAL, HEATING AND COOLING LOADS SIZED IN ACCORDANCE WITH NEC AND IBC CODES. COST TO COMPLY WITH LOCAL CODES BEYOND THE ATTACHED FLOOR PLAN AND SPECIFICATIONS IS THE RESPONSIBILITY OF THE OWNER.</p> <p>CUSTOMER WILL MAKE SITE ACCESSIBLE FOR MODULAR INDUSTRY DELIVERY VEHICLES WHEN PMB IS READY TO DELIVER MODULAR SECTIONS.</p> <p>IF SITE IS NOT READY IN TIME FOR DELIVERY OF MODULES, CUSTOMER AGREES TO REIMBURSE PMB FOR TEMPORARY STORAGE, STAGING AND/OR DAMAGES WHILE MODULES ARE STORED.</p>	
SCOPE	
<p>PMB WILL MANUFACTURE ALL MODULES IN ACCORDANCE WITH STATE AND CUSTOMER APPROVED DRAWINGS</p> <p>PMB WILL TRUCK SET ALL MODULAR BUILDINGS IN ACCORDANCE WITH A MUTUALLY AGREED SITE PLAN.</p> <p>PMB WILL MAKE FINAL MODULAR MATE LINE STRUCTURAL CONNECTIONS AND FINISHES INCLUDING ELECTRICAL AND HVAC CROSSOVERS PROVIDED BY PMB IN THE FIELD</p> <p>PMB WILL PROVIDE AND INSTALL PRESSURE TREATED WOOD FRAMING WITH SIDING TO MATCH EXTERIOR OF BUILDING INCLUDING VENTILATION & SKIRT PANEL ACCESS</p> <p>ROOF SLOPE TO ACCOMMODATE MODULAR CONSTRUCTION METHODS</p> <p>CUSTOMER WILL PROVIDE APPROPRIATE AND CURRENT GEOTECHNICAL INFORMATION AS REQUIRED FOR FOUNDATION LAYOUT, NO FOUNDATION DESIGN IS INCLUDED</p> <p>PMB WILL PROVIDE STANDARD MODULAR STATE APPROVALS AND ENGINEERING (IF STATE HAS A MODULAR BUILDING PROGRAM)</p> <p>PMB STANDARD GENERAL LIABILITY UNTIL PMB WORK IS COMPLETE.</p> <p>STANDARD PMB WARRANTY INFORMATION PROVIDED AT THE COMPLETION OF THE PROJECT.</p> <p>STANDARD PMB TECHNICAL INPUT (SUBMITTAL PACKAGE) PROVIDED FOR CUSTOMER REVIEW AND APPROVAL.</p>	
EXCLUSIONS	
<p>ALL UTILITIES, SITE WORK, SITE PREPARATION, ACCESS FOR MODULAR UNITS, HAULING ROADS, CRANES OR ACCESS ROADS</p> <p>ADA ACCESSIBILITY</p> <p>BELOW GRADE FOOTERS</p> <p>FOUNDATION DESIGN</p> <p>ANY AND ALL WORK NOT ASSOCIATED WITH THE MODULAR BUILDING</p> <p>FINAL CONNECTION OF ALL UTILITIES</p> <p>MANIFOLDING OF WASTE LINES UNDER BUILDING IF BUILDING HAS PLUMBING</p> <p>FURNITURE, FIXTURES OR EQUIPMENT</p> <p>CARD ACCESS READERS</p> <p>LOW VOLTAGE WIRING INCLUDING, FIRE ALARM, PHONE, DATA, COAXIAL, MASS NOTIFICATION, PA SYSTEM, CCTV, SECURITY, ETC.</p> <p>BUILDERS RISK INSURANCE</p> <p>ANY HORIZONTAL CONDUIT FOR LOW VOLTAGE WIRING</p>	

FIRE SUPPRESSION OR FIRE ALARM SYSTEMS
DUMPSTER, PMB WILL PLACE TRASH AND CONSTRUCTION DEBRIS IN A CLOSE RECEPTACLE TO THE BUILDING WHICH IS PROVIDE BY THE CUSTOMER
PORT-A-POTTY
TEMPORARY ELECTRIC
TEST AND BALANCE OF THE HVAC SYSTEM
CRANES, MAN LIFTS OR FORKLIFTS
SIGNAGE
SURVEYING
STAKING OF THE SITE TO SHOW WHERE BUILDING IS GOING.
CLEANING OF ANY KIND BEYOND BROOM SWEEP
TAXES AND BONDING OF ANY KIND
LOCAL ZONING AND DEED RESTRICTIONS
PERMITS INCLUDING BUT NOT LIMITED TO BUILDING PERMITS, LICENSING COSTS AND IMPACT FEES.
PRESSURE TREATED WOOD OR METAL DECKS, STEP AND RAMPS PER ADA REQUIREMENTS
GUTTERS, DOWNSPOUTS AND SPLASH BLOCKS
CANOPIES
ASPHALT OR CONCRETE PARKING LOT, INCLUDING DRIVES, ENTRIES, CURBS, SIGNAGE, ETC. AS OR IF REQUIRED
REINFORCED CONCRETE FOR SIDE WALKS, ROADS, RAMPS, STOOPS, DECKS, STEPS AND EQUIPMENT PADS

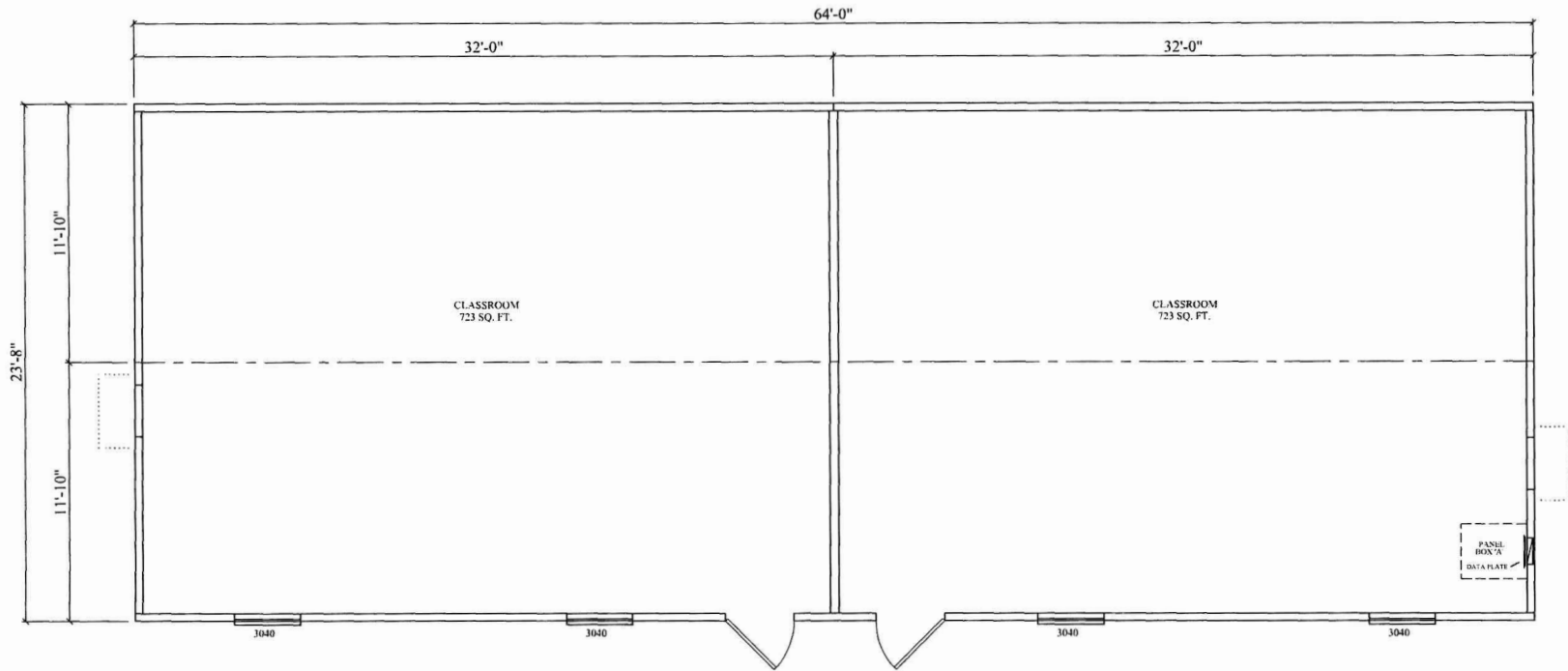

PALOMAR
MODULAR BUILDINGS LLC

DESCRIPTION:

2 CLASSROOM BUILDING DRY

MODEL NUMBER:

2 CLASSROOM DRY

BUILDING AREA:

1515 SQ. FT.

VISIT US @:

PHYSICAL ADDRESS: 505 N. 135 E. DESOTO, TX. 75115
MAILING ADDRESS: PO BOX 908 DESOTO, TX. 75123
VIA PHONE @ (949) 325-0727 OR (949) 913-4587
ON THE WEB @ info@palomarmodular.com
VISIT OUR WEB SITE @ palomarmodularbuildings.com

© 2015 PALOMAR MODULAR BUILDINGS LLC. ALL RIGHTS RESERVED



Williams Scotsman inc
 4590 Carey Street
 FORT WORTH TX
 76119-4222
 Toll Free: 800-782-1500

Your Sales Representative
 Don Williamson
Phone: (469) 559-7122
Email:
 don.williamson@willscot.com

Agreement Number:
 Q-1371552
Revision: 1
Date: 5/12/2023
Expiration Date:
 6/1/2023

Sale Agreement For New Equipment With Limited Warranty

Buyer: Mineral Wells ISD 906 SW 5th Ave Mineral Wells, TX 760678445	Contact: Trey Evans 906 SW 5th Ave Mineral Wells, TX 760678445, US Phone: 9404525717 E-mail: tevans@mwisd.net	Ship To Address: 7852 Umphress Rd Dallas, TX 75217, US Delivery Date (on or about): 08/01/23
---	---	---

Unit Description and Pricing	Quantity	Price	Extended
64x24 Classroom (60x24 Box)	1	\$ 141,700.00	\$ 141,700.00
Fuel Surcharge Delivery	2	\$ 322.61	\$ 645.22
Standard Complex Setup and Anchor	1	\$ 7,380.00	\$ 7,380.00
Delivery - 12' wide	2	\$ 1,194.85	\$ 2,389.70
Total Purchase Price Including Delivery And Installation (If Applicable)*:			\$ 152,114.92
Total Purchase Price Including Delivery And Installation (If Applicable)* Including Estimated Taxes:			\$ 164,310.15

Scope Of Work

Summary of Charges

Model: 64x24 Classroom (60x24 Box)	QUANTITY: 1	Total Charges for(1) Building(s): \$ 152,114.92
		Total Charges for (1) Building(s) Including Estimated Tax: \$ 164,310.15

Additional Services: For your convenience, we also recommend the following items (not included in this Agreement)

BY INITIALING BELOW, BUYER/LESSEE/CUSTOMER HEREBY ACKNOWLEDGES AND CONFIRMS THAT IT HAS SELECTED THE INITIALED RECOMMENDED ITEMS TO BE ADDED TO THIS CONTRACT AND AGREES TO PAY THE ADDITIONAL SPECIFIED AMOUNT(S) IN ACCORDANCE WITH THE TERMS AND CONDITIONS OF THIS CONTRACT.

Initial	Recommended Items	Billing Frequency	Qty	Price	Extended
---------	-------------------	-------------------	-----	-------	----------



Williams Scotsman inc
 4590 Carey Street
 FORT WORTH TX
 76119-4222
 Toll Free: 800-782-1500

Your Sales Representative
 Don Williamson
 Phone: (469) 559-7122
 Email:
 don.williamson@willscot.com

Agreement Number:
 Q-1371552
 Revision: 1
 Date: 5/12/2023
 Expiration Date:
 6/1/2023

Payment Terms

Credit Terms: 50% due upon signing, 25% due upon unit delivery and remaining, 25% due upon substantial completion.

Acknowledgement

This Sales Agreement (the "Agreement") is made on May, 11, 2023, by and between WillScot, a Maryland corporation, doing business at 4255 Carbon Road, Irving, TX 75038 ("Seller") and Mineral Wells ISD ("Buyer"), doing business at the address noted above.

Buyer agrees to purchase from Seller one or more trailer(s) and/or relocatable modular and/or pre-fabricated structures, including stairs, railings, furniture, and other items attached or appurtenant thereto, as noted above and detailed on any Addenda to this Agreement (hereinafter collectively referred to as the "Equipment"), for the purchase price and payment terms and subject to the terms and conditions set forth of this Agreement and as detailed on the Addenda to this Agreement. The Agreement and the Addenda together form the "Contract Documents". The Addenda are as follows and are an integral part of this Agreement.

Addenda: No Addenda attached.

*All prices exclude applicable taxes.

By its signature below, Buyer hereby acknowledges that it has read and agrees to be bound by the Seller's Sales Agreement Additional Terms and Conditions (11-30-11) located on Seller's internet site (<https://www.willscot.com/About/terms-conditions>) in their entirety, which are incorporated herein by reference and agrees to purchase the Equipment from Seller subject to the terms therein.

LIMITED WARRANTY: Seller hereby warrants to Buyer that at the time of delivery Seller has good and marketable title to the Equipment, free and clear of all liens and encumbrances arising by or through the Seller. Seller warrants to Buyer that the materials and equipment (the "Equipment") furnished by Seller hereunder will be of good quality and new (factory built) and free from defects for a period of one (1) year from the date of delivery of the Equipment. Further, Seller hereby assigns to Buyer all assignable manufacturers' warranties, which shall be subject to the specific manufacturer's warranty provisions and time period. During the warranty period, Seller shall repair or replace all defective parts of the Equipment which are covered under Seller's warranty, (excluding maintenance items such as HVAC filters, fire extinguishers, fuses/ breakers, and light bulbs). Seller's warranty excludes repairs for damage or defect caused by abuse, work or modifications not executed by Seller, Buyer's alteration of the Equipment, improper or insufficient maintenance, improper operation, unreasonable and/or excessive use, or use of the Equipment for a purpose for which it was not intended or other misuse. Seller shall have no liability whatsoever for any consequential or incidental damages, costs or expenses arising from the Equipment, the work or any other factor. **Except as expressly stated herein, Seller disclaims any and all other warranties, either expressed or implied, including without limitation all warranties of merchantability, fitness for a particular purpose or usage of trade.**

Signatures

BUYER (Name): Mineral Wells ISD	SELLER: Williams Scotsman inc
Signature:	Signature:
Print Name:	Print Name:
Title:	Title:
Date:	Date:
PO#:	

Williams Scotsman now issues paperless invoices via email, an efficient, convenient & environmentally friendly process. Go green and provide us with the proper email address for your invoices.

AP Email:

No thanks. Please mail my invoices to:
 906 SW 5th Ave
 Mineral Wells, TX 760678445, US

Date: May 10, 2023

Quote Number: AC-0198-2023 v-02

Size: 24 x 64 Description: 24x68 O/A Dry Classroom Mineral Wells ISD

<u>COMPONENT</u>	<u>SUB-COMPONENT</u>	<u>DESCRIPTION</u>	<u>QUANTITY</u>
FRAME			
	OUTRIGGER	12' X 64' - 12" X 11.8# I-Beam O/R @ 4' O/C	2.00
	AXLES	Quad Axles 2-Brake & 2-Idler (New)	2.00
FLOOR			
	JOIST	2 X 8 @ 16" O/C Wood Floor Joist 50# Floor Load	
	DECKING	Sturd-I-Floor 23/32"X4'X8' T&G	
	INSULATION	Insulation R-30C Unfaced (Floor)	
	COVERING	Vinyl Composition Tile (VCT) 1/8"	
EXTERIOR WALL			
	STUDS	2 X 6 Ext. Wood Wall Framing	
	SHEATHING	OSB (Sheathing) 7/16"	
	SIDING	Ext. Wall R-Panel 26ga Painted W/Housewrap	
	INSULATION	Insulation R-19 Kraft (Exterior Walls)	
	COVERING	5/8" Vinyl Covered Gypsum 9'-10' Tall for Exterior Wall W/ Wrapped Battens	
INTERIOR WALL			
	STUDS	Int. Wall 2 X 4 X 8' @ 16" O/C	
	FOR FULL HEIGHT WALL BUILD UP	Wall Extended To Rafters - Approx 2ft	
	COVERING	5/8" Vinyl Covered Gypsum 8' Tall W/ Wrapped Battens	
	INSULATION	R-11 Unfaced for 8' Interior Wall	
INTERIOR TRIM			
	COVE BASE	Wall Base Vinyl 4"	
ROOF			
	JOIST	Roof Joist 2 X 8 @ 24" O/C To Form 20# Gable Style Roof Slope; Roof Slopes Toward Sidewalls	

SPEC SHEET

Date: May 10, 2023

Quote Number: AC-0198-2023 v-02

Size: 24 x 64 Description: 24x68 O/A Dry Classroom Mineral Wells ISD

<u>COMPONENT</u>	<u>SUB-COMPONENT</u>	<u>DESCRIPTION</u>	<u>QUANTITY</u>
ROOF			
	DECKING	7/16" OSB Decking	
	BEAM	Plywood Ridge Beam 4 Layer 24" Tall	
	INSULATION	Insulation R-38C Unfaced (Roof)	
	CEILING	Ceiling Suspended 2' X 4' #769A With Grid 7' 10" A.F.F.	
	COVERING	Galvalume R-Panel 26ga	
WINDOW			
	WINDOW	4/0 X 3/0 HS Vinyl - Low E - Insulated Glass	4.00
	MINI BLINDS	No Mini Blinds Quoted	
EXTERIOR DOOR			
	DOOR	3/0 X 6/8 Telstar Pro Door - Std Colors Only	4.00
	LOCKSET	Exit Device (Panic) Tell 8300B Series With Entry Trim CTL881 (Lever)	4.00
	HARDWARE	Door Closer Tell Hydraulic	4.00
	ACCESSORIES	Vision Panel 6" X 27" X 1/4" Clear Tempered Glass	4.00
INTERIOR DOOR			
	DOOR	No Interior Doors	
ELECTRICAL			
	WIRE	MC Cable (Wire)	
	PANEL	Load Center 200A (Main Breaker) Outdoor	1.00
	LIGHT	Emergency/Exit Light W/Remote Head (Exterior)	4.00
	LIGHT	Troffer LED 2' X 4' - Flat Panel (Dimmable) 5000 LUMEN	16.00
	EXTERIOR LIGHTS	Outside Light With Photo Control LED	4.00
	SWITCH	Switch Occupancy Sensor Ceiling Mount (MC Cable)	2.00
	RECEPTACLE	Receptacle Duplex 20A Exterior W/R W/ Cover / Tamper Resistant	2.00

Date: May 10, 2023

Quote Number: AC-0198-2023 v-02

Size: 24 x 64 Description: 24x68 O/A Dry Classroom Mineral Wells ISD

<u>COMPONENT</u>	<u>SUB-COMPONENT</u>	<u>DESCRIPTION</u>	<u>QUANTITY</u>
ELECTRICAL	RECEPTACLE	Receptacle Duplex 20-Amp Tamper Resistant (MC Cable)	14.00
	BOXES	J-Box 4" Assembly	10.00
	BOXES	J-Box 4" Assembly Wired 1 ea classroom for future use, 1 Future F.A.C.P.	3.00
	ACCESSORIES	Cross Over (Electrical)	
PLUMBING	WATER HEATERS	No Plumbing Quoted	
MECHANICAL	A/C - WALL MOUNT	A/C 3-ton / 10 KW Heat Strip. "Bard or Eubank or Equal"	2.00
	CRV'S & ECONOMIZERS	CRV3 For 2.5 - 3 Ton A/C	2.00
	OTHER	Fiberglass Duct Supply, Flex, Collars & S/A Grill	
	OTHER	Return Grill 30" X 16" @ A/C (Wall)	
	OTHER	Air Supply Drop 6" Grill, Flex, Collars, Damper	8.00
FURNISHINGS	COUNTERTOPS	No Furnishings Quoted	
MISC	CLOSE UP	Close Up	
OTHER	STATE APPROVALS	State Code TX	1.00
	ROOF LOAD	Roof Load 20#	1.00
	WIND LOAD	Wind Load 120 MPH	1.00
	SEISMIC DESIGN	Seismic Design C	1.00



BOARD OF TRUSTEES

Agenda Item

MEETING DATE: 6/12/23

MEETING TYPE:

- Regular Meeting
- Special Meeting

AGENDA ITEM TYPE:

- Action Item
- Non-Action Item

BOARD GOALS (check all that apply)

Academic Goals

- Academic Competitiveness
 - Early Literacy (HB3)
 - Early Math (HB3)
 - Other
- Career Certifications (HB3)

Operational Goals

- Promote Community/School Partnerships
- Fiscal Responsibility
- Safe and Secure Schools

TITLE: Discuss, consider, and take any necessary action regarding authorizing the superintendent to take all actions necessary for ensuring the installation or construction of a replacement high school greenhouse.

RECOMMENDED ACTION: It is recommended that the school board authorize the superintendent to take all actions necessary to ensure the installation or construction of a replacement high school greenhouse.

BOARD POLICY/STATE REGULATION/LAW REFERENCE (if applicable): Gov't Code 2269, CV (LEGAL), CV (LOCAL), CVA (LEGAL), CVA (LOCAL), CVB (LEGAL), CVB (LOCAL), CVC (LEGAL), CVD (LEGAL), CVE (LEGAL), CVF (LEGAL)

OVERVIEW:

The board has authority under Government Code Chapter 2269 to enter into contracts for the delivery of construction projects. MWISD Board Policy Code CV (LEGAL) permits the school board to delegate its authority under Government Code Chapter 2269 to a designated representative, which could include the district superintendent. With such delegation, the superintendent would be authorized to enter into a contract with a construction firm and would be authorized to enter into an agreement with an architect to meet policy requirements. All bidding and purchasing requirements would still be in effect if this is delegated to the superintendent or if it is not. The board also has the right to delegate this task to a representative and establish a spending limit.

FISCAL IMPACT: \$214,900.00

ATTACHMENTS: Bid documents; architect proposal

DEPARTMENT(S) SUBMITTING FORM: Maintenance

DEPARTMENT SIGNATURE/APPROVAL:

Trey Evans

[Signature]

Greenhouse

Recommend L.J. Design and Construction based on their experience and price \$214,900.

Additional Cost

Remove the block retaining walls and replace them with concrete.

Move the utilities and add drainage to NW side of the high school \$20,000.

L.J. Design & Construction LLC

6548 Peden Rd
 Fort Worth, TX 76179
 817-999-6025
 l.j.design@earthlink.net

*Recommend
 L.J. Design & Construction
 for the install*

Name / Address
 Mineral Wells ISD
 Trey Evans
 906 SW 5th ave.
 Mineral Wells, Texas 76067

Greenhouse Install 42x60

Item	Description	Qty	U/M	Cost	Total
02.10 Demo	Demo - Greenhouse and haul off Saw cut, remove and haul off side walk and border Remove pea gravel and haul off	1		17,500.00	17,500.00
04 Concrete	Concrete - Pour 42' x 60' concrete slab w/ 4 ea. #5 bars in the beams and #4 bars in the top 8' x 42' trench drain w/ galvanized 1" grate. Engineered Foundation Plan.	1		44,500.00	44,500.00
Green House In...	Install Greenhouse 42x60	1		42,550.00	42,550.00
Electrical	Install breaker panel and wire greenhouse	1		10,500.00	10,500.00
14 Plumbing	Plumbing - Run gas lines and water	1		5,250.00	5,250.00
Other	Stuppy 42x60 Greenhouse	1		78,400.00	78,400.00
Other	Benches and Irrigation	1		16,200.00	16,200.00
	Price assumes that the utilities are within 5" of the Greenhouse				
				Sales Tax (6.25%)	\$0.00

Total \$214,900.00

Customer Signature _____



NAE CONTRACTING

843 S. Cherry Lane, Fort Worth TX 7108 - Office 817-220-2200

May 11, 2023

Unclassified - Proposal

Mineral Wells ISD Greenhouse

Greenhouse & Equipment to construct 42'x60':

- Disconnect utilities.
- Demolish existing greenhouse and structure.
- Install a new 42' x 60' greenhouse.
- (12) 4'x12' Benches (for 42'x60')
- Irrigation (for 42'x60')
- 120-day minimum lead-time for Stuppy structure.
- Stamped drawings to be supplied by Stuppy.
- Permits and taxes not included.
- Includes Alternate #01 40x060 slab with floor drains.

Total*** \$212,334

Please contact me directly at 469-516-4719 if you have any questions.

Respectfully,
Ray Pinero
Director of Operations
NAE Contracting

Plantation Greenhouse
PO Box 3301
Burleson, Texas 76097

Rodney Wimberley
817-822-7009 cell
rodney@Plantationgreenhouses.com

Quote #BR549/24

Customer: Mineral Wells ISD-Trey Evans DATE: 2/24/2023

Address:

City: Mineral Wells State: Texas Zip:

Phone 940-452-5717 Email tevens@mwsd.net

QTY.	Description	Unit Price	Total
1 Lot	30'x60' Gable Style Greenhouse consisting of: Complete roll form galvanized steel frame system, base angle & base plates for bolting to concrete foundation, completely covered with 8mm clear polycarbonate, cooling system sized as required, rack & pinion vent door on endwall at cooler, 2- slantwall exhaust fans sized for CFM required, Automatic internal shade system, HAF fans for air circulation, 8' sidewalls, 250,000 BTU heater, 2-36" swing door, 3-runs of hanging basket drip irrigation, designed to withstand 105 mph wind and 10lb snow load, professionally installed on concrete foundation.		

----- \$84,750.00

Included: Per local codes & standards Electrical, Plumbing & Cement Pad \$45,000.00

-

Total \$129,750.00

Terms: ½ down with order, ¼ after foundation complete Greenhouse delivered installation started, balance at completion

Remit payment to: PO Box 3301

Burleson, Texas 76028

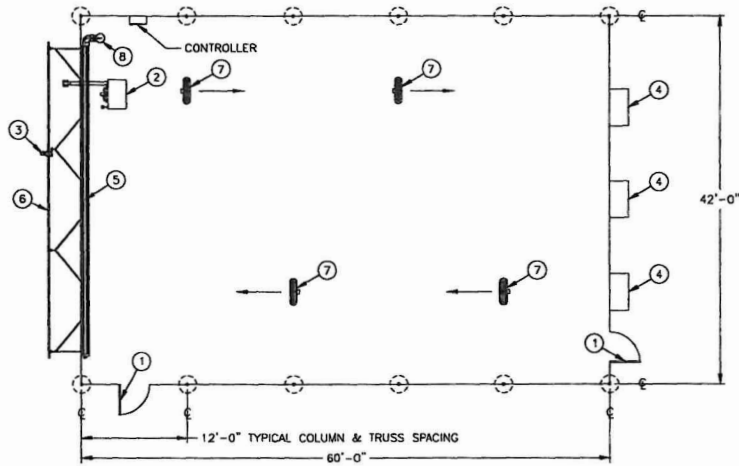

PLAN VIEW

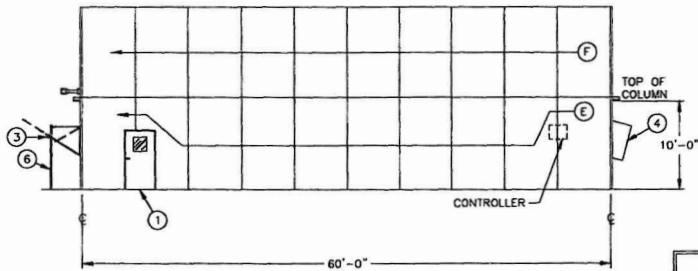

EAST SIDEWALL ELEVATION

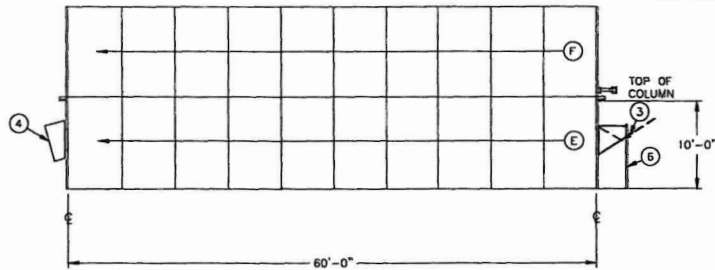

WEST SIDEWALL ELEVATION

ITEM #	MATERIAL LIST - PART DESCRIPTION	QTY
1	42" PERSONNEL DOOR	2
2	MDN PTP 250 HEATER	1
3	RIGID VENT MOTOR	1
4	42" EXHAUST FAN	1
5	6" X 36" EVAP. COOLING PAD	35
6	36" RIGID VENT SYS 1-1/4" DR	3SFT
7	MAF FAN	4
8	PVC 6" X 35" EVAP. COOLING PLUMBING KIT	1

TR	ITEM #	MATERIAL LIST - PANEL DESCRIPTION	QTY
A	----	BMM TW 71.25" CLEAR x 21'-6"	2
B	----	BMM TW 71.25" CLEAR x 20'-0"	4
C	----	BMM TW 71.25" CLEAR x 17'-0"	4
D	----	BMM TW 71.25" CLEAR x 14'-0"	4
E	----	BMM TW 71.25" CLEAR x 11'-0"	20
F	----	BMM TW 71.25" CLEAR x 23'-6"	20

NOTES:

- CHECK WITH CUSTOMER FOR EXACT LOCATION OF DOORS AND ALL EQUIPMENT.
- REFER TO ENDWALL FRAMING DRAWINGS FOR ASSEMBLY OF ENDWALLS.
- IN THE EVENT OF UNINTENDED CONFLICT OF EQUIPMENT PLACEMENT & CODE STRUCTURE, WHEN APPLICABLE, PRIORITY WILL BE GIVEN TO CODE STRUCTURE.

THIS DRAWING IS FOR PRELIMINARY USE ONLY AND SHOULD NOT BE USED IN THE CONSTRUCTION OF THE GREENHOUSE OR DESIGN OF GREENHOUSE FOUNDATION

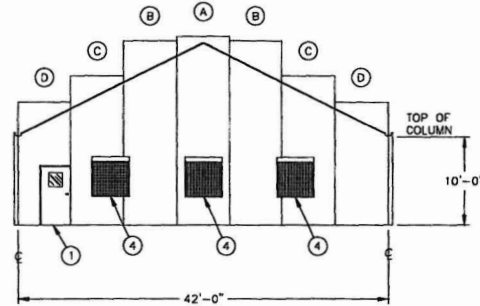

NORTH ENDWALL ELEVATION

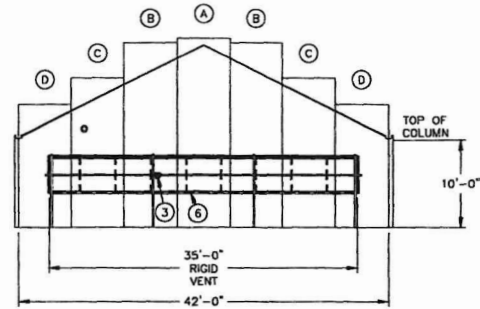

SOUTH ENDWALL ELEVATION

Good to know.
Stuppy
 General Bldg., Remodeling & Custom
 1112 Clay Street PO Box 1245
 North Kansas City, MO 64116
 816.423.1371 www.stuppy.com

MINERAL WELLS INDEPENDENT SCHOOL DISTRICT
 MINERAL WELLS, TX 76067

PROJECT # PRELIMINARY #2

ISSUE DATE
 04 04 2023
 REVISIONS
 DRAWN CHECKED
 BPG
 SHEET
GS-002
 EQUIPMENT LAYOUT

Good to know.

Stuppy
GREENHOUSE

Greenhouse Design, Manufacturing & Co

Info on
Manufacturer we
Recommend

Stuppy, Inc. Statement of

Stuppy, Inc.

1212 Clay

North Kansas City, MO 64116

Phone: 1.800.733.5025

Fax: 1.800.423.1513

Stuppy, Inc.

1212 Clay Street • North Kansas City, Missouri 64116 • 800-733-5025 • greenhouse@stuppy.com • www.stuppy.com



Company Overview

- Stuppy Floral Company was formed in 1873 in St. Joseph, Missouri. Throughout its history the company grew to include floral distribution, greenhouse manufacturing, and greenhouse construction services.
- While the floral growing operation was suspended due to changes in the market, the company continues to maintain its roots in horticulture and controlled growing of plants with a growing presence as an industry leader in the manufacturing and construction of quality greenhouse and other horticultural growing structures.
- The Stuppy Family has been committed to the industry and values the relationships made along the way.
- Now under its fifth generation of operation, Matt Stuppy oversees the daily operations of the expanded organizations of Stuppy, Inc.
- Stuppy, Inc. now offers exceptional experience and expert knowledge in the service of designing and consulting throughout all phases of building greenhouses.
- Stuppy, Inc. has the capabilities to tailor any greenhouse package to meet the specific need of virtually any owner. Stuppy can also provide turn-key solutions for new construction, repair and refurbishment of existing facilities, and materials to greenhouse owners and builders.
- Our offices and manufacturing plant total 80,000 sq. ft. and are located at 1212 Clay St. in North Kansas City, Missouri. In addition to greenhouse design, production, and project management, Stuppy also has field sales personnel who are available for consultation.
- Stuppy is committed to delivering projects that function based the owner's requirements and even more importantly, the plants themselves.

Stuppy, Inc.

1212 Clay Street • North Kansas City, Missouri 64116 • 800-733-5025 • greenhouse@stuppy.com • www.stuppy.com

Good to know.



Greenhouse Design, Manufacturing & Construction

Why Stuppy, Incorporated?

- When you choose a greenhouse from Stuppy, you get much more than a great greenhouse. You get the knowledge and reputation that's helped to make our company an industry leader.
- Our greenhouses are designed and tested to give you the features that you need. Many of our greenhouses have been designed by you, the customer. We've listened to what our customers have wanted – what works and what does not work in actual field use – and we have custom designed our structures to offer you only the best of everything.
- We design an environment that is tailored to meet your requirements. Our design includes more than just the structure. We make certain your greenhouse contains all the right equipment to be able to suit the needs of the climate, year-round. Our engineering department uses the latest in computer aided design software to be able to respond quickly and professionally to your needs.
- Stuppy uses Allied Tubing's High Strength Tubing at 50,000 psi yield and 55,000 psi tensile and Super Strength Tubing at 60,000 psi yield and 75,000 psi tensile with Gatorshield triple layer galvanizing to provide superior strength and corrosion resistance to our structural components.
- Stuppy's partnership with industry leaders such as Acme, American Coolair, Old Castle Glass, Wadsworth Controls, Link4 Controls, Modine, Lock Drives, Ridder USA, GE, Dynaglas, and DeGlas allow us to offer top products at affordable prices; along with excellent service and availability. Selected models and sizes are stocked at our warehouse in Missouri to offer you fast delivery.
- We have much more than just a great product line. We believe our service to be superior. Service is really where our job begins. Before we begin quoting your greenhouse, a sales representative visits your operation to help determine your specific needs. Our staff will be there every step of the way, from that first phone call till the last nut and bolt is installed. Our experienced and knowledgeable staff is here to make your project a successful reality.

Stuppy, Inc.

1212 Clay Street • North Kansas City, Missouri 64116 • 800-733-5025 • greenhouse@stuppy.com • www.stuppy.com



Stuppy carries vast knowledge and credibility in working with educational facilities and their greenhouse requirements. Stuppy has completed, is in construction, or has in queue the following greenhouse new-build projects in your region within the last five years:

- Langston University (OK)
- Chickasha High School (OK)
- NE Oklahoma A&M College (OK)
- Eastern Ok. State College (OK)
- Broken Bow High School (OK)
- Broken Arrow STEM Center (OK)
- Elgin Public Schools (OK)
- Ocean Springs High School (MS)
- Lovington High School (NM)
- Hot Springs High School (NM)
- NMSU Farmington (NM)
- City of Raton (NM)
- Lovington High School (NM)
- Troy ISD (TX)
- Amarillo College (TX)
- Sul Ross State University (TX)
- Eastern Oklahoma State College
- Tarleton State University (TX)
- Lewisville ISD CTE Center (TX)
- Prosper High School #2 (TX)
- Prosper High School #3 (TX)
- Whitehouse ISD (TX)
- Arlington CTE Center (TX)
- Lubbock Christian University (TX)
- Porter HS (New Caney ISD) (TX)
- Wichita Falls ISD (TX)
- Klein High School (TX)
- Klein Forest High School (TX)
- Texas A&M University (TX)
- Northeast Texas CC (TX)
- Dallas Arboretum (TX)
- Pearland ISD (TX)
- Eustace ISD (TX)
- Winnsboro ISD (TX)
- Ector ISD (TX)
- Conroe HS (TX)
- Caddo Mills HS (TX)
- Coldspring/Oakhurst HS (TX)
- Midland College (TX)
- Temple ISD (TX)
- Skyline High School (TX)
- Waxahachie High School (TX)
- Hamshire-Fannett HS (TX)
- Eastland ISD (TX)
- UT Southwestern (TX)
- Normangee ISD (TX)
- Tarrant County College (TX)
- Grape Creek ISD (TX)

The following pages highlight several of these projects, as well as similar educational or research greenhouses projects completed by Stuppy.

Good to know.



Project Profile – Dallas Arboretum (2018)



Project Owner:

Dallas Arboretum Production Greenhouse
Dallas, TX
John Armstrong – VP of Property Development
214.515.6699

Architect:

Jacobs Engineering Group, Inc.
Fort Worth, TX
David Gustaf

General Contractor:

McCaslin Hill Construction
San Antonio, TX
Steve Calhoun
972.741.8819

Stuppy, Inc. was awarded a contract in Spring 2018 to erect a 20,000 square foot production greenhouse for the Dallas Arboretum and completed it in November of 2018. The CS3 A-Frame greenhouse model is pictured, and is very common for educational and research greenhouses.

Stuppy, Inc.

1212 Clay Street • North Kansas City, Missouri 64116 • 800-733-5025 • greenhouse@stuppy.com • www.stuppy.com

Good to know.

Stuppy Greenhouse Design, Manufacturing & Construction
GREENHOUSE

Project Profile – Amarillo College (2018)



Project Owner:

Amarillo College
Amarillo, TX
Gerek Burford – Green Director
806.371.5152

Architect:

Parkhill Smith Cooper
Amarillo, TX
Susan Wilson

General Contractor:

Wiley Hicks Jr. Inc.
Amarillo, TX
Wiley Hicks Jr - Owner
806.376.5941

Stuppy, Inc.

1212 Clay Street • North Kansas City, Missouri 64116 • 800-733-5025 • greenhouse@stuppy.com • www.stuppy.com

Good to know.



Project Profile – Bynum School (2018)

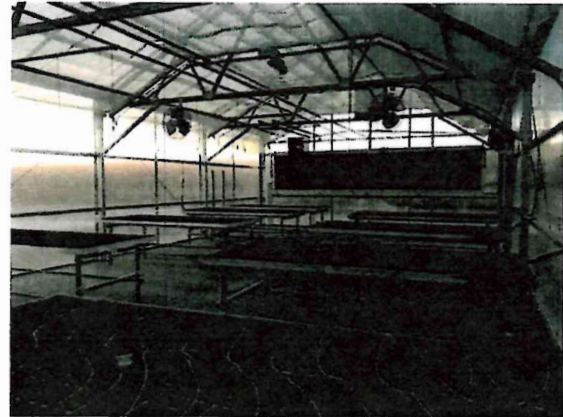

Project Owner:

Bynum School
Bynum, TX
Dr. Bill Maurer, Executive Director

Architect:

RWA Architects
Midland, TX
TJ McClure
(432) 682-1252

General Contractor:

N/A

Stuppy, Inc.

1212 Clay Street • North Kansas City, Missouri 64116 • 800-733-5025 • greenhouse@stuppy.com • www.stuppy.com

Good to know.



Project Profile – University of North Texas (2011)

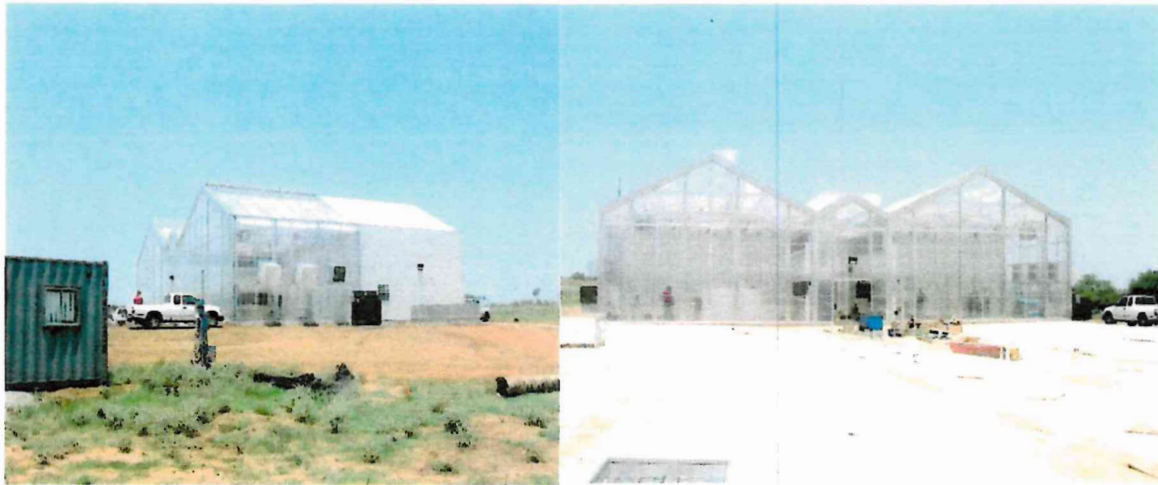

Project: University of North Texas – Discovery Park Greenhouse
Denton, TX
Helen Bailey
940.369.7886

Architect: Jacobs Engineering Group, Inc.
Fort Worth, TX
David Gustaf

General Contractor: Alpha Building Corporation
San Antonio, TX
Miles Wilson

Stuppy, Inc. was awarded a contract in August of 2011 to erect an 84' x 60' research facility at the University of North Texas Discovery Park. The facility was designed as a 30' x 84' head house and 30' x 84' greenhouse that was to be separated by a partition wall.

The facility was designed to accommodate future additions to the greenhouse end of the structure. The south end wall acts as an end wall that could be converted to a partition wall in the future. That is not as easy as it seems and Stuppy's engineering department did a great job designing the convertible end wall.

The facility was designed for sugar cane research which brought along with it a few design challenges. Sugar cane can grow more than 18' tall. The greenhouse was to have 18' of clearance from the finished floor elevation to the bottom of the truss. The design of the switch from the corrugated metal covering to acrylic covering was also a critical design issue.

Stuppy, Inc.

1212 Clay Street • North Kansas City, Missouri 64116 • 800-733-5025 • greenhouse@stuppy.com • www.stuppy.com

Good to know.



Project Profile – Joliet Junior College

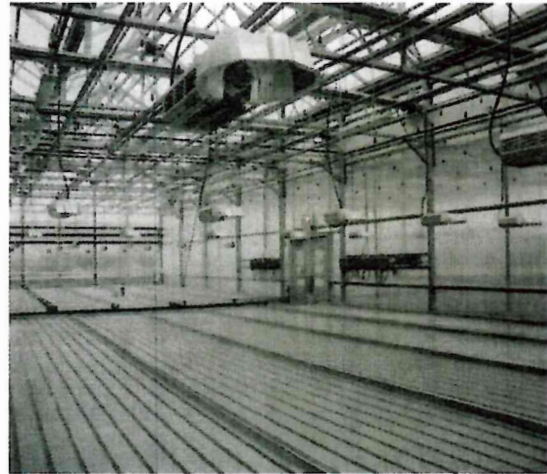
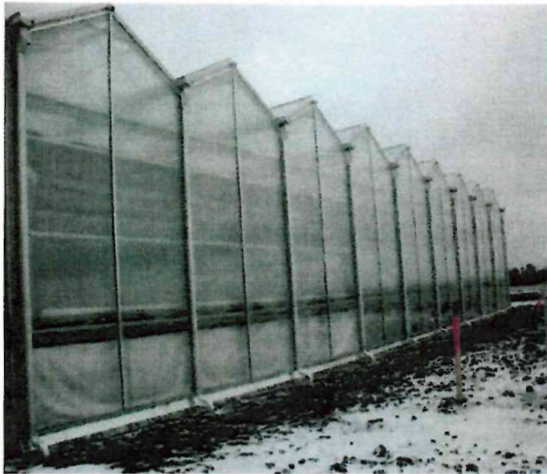

- Project:** Joliet Junior College
Joliet, IL
- Architect:** Legat Architects
80 N. Virginia St Suite C
Chrystal Lake, IL
312.756.1244
- General Contractor:** Gilbane Building Company
Chicago, IL
Alan P. Zakariya
773.695.3520
- Owner:** Joliet Junior College
1215 Houbolt Road
Joliet, IL 60431

The expansion and moving of the Horticulture Department offered the Joliet Junior College the ability to construct new facilities with a Silver LEED design. This 9,000 square foot open roof structure is one of only a few LEED certified greenhouses in the nation. Stuppy, Inc. was contracted to erect this new open roof structure attached to a new head house and class rooms for the relocated horticulture facility. The union constructed project was delivered/erected on schedule with a Gilbane rating subcontractor reference of 8.983 out of 10.

Stuppy, Inc.

1212 Clay Street • North Kansas City, Missouri 64116 • 800-733-5025 • greenhouse@stuppy.com • www.stuppy.com

Good to know.



Project Profile – USDA Vector and Citrus Growing Houses

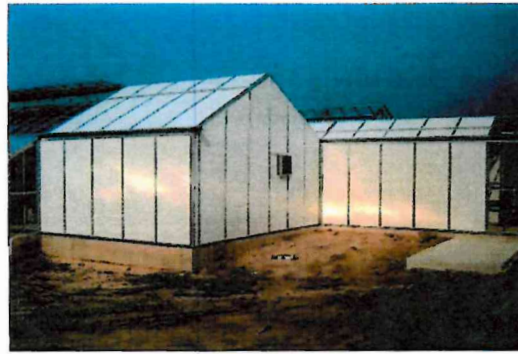
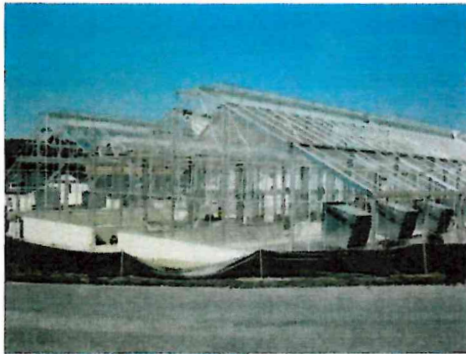

Project: USDA Vector and Citrus Growing Houses
Beltsville, MD

Architect: Agritech Nove, Inc.
Saint Anselme, QC, Canada
Richard Denis, Principal
418.885.9595

General Contractor: Maple Construction
Gutam Dalal, President
301.548.9547

Engineer: RMF Engineering, Inc.
Kenton Balenske, VP
410.546.0505

USDA Contract Administrator: Robert Drechsler
301.504.1217

Stuppy Inc., was awarded a contract to supply and construct Biolevel II greenhouses for research at the USDA in Beltsville, MD. While the structure was carefully designed by the architect; SGM initiated subsequent research and conversations with the qualifying agency, APHIS, which resulted in necessary structural changes. It is always our aim to ask the tough questions and research equitable answers that differentiates us.

Stuppy, Inc.

1212 Clay Street • North Kansas City, Missouri 64116 • 800-733-5025 • greenhouse@stuppy.com • www.stuppy.com

Good to know.

Stuppy Greenhouse Design, Manufacturing & Construction
GREENHOUSE

Various Education Project Pictures



Stuppy, Inc.

1212 Clay Street • North Kansas City, Missouri 64116 • 800-733-5025 • greenhouse@stuppy.com • www.stuppy.com

Good to know.

Stuppy

Greenhouse Design, Manufacturing & Construction

GREENHOUSE



Stuppy, Inc.

1212 Clay Street • North Kansas City, Missouri 64116 • 800-733-5025 • greenhouse@stuppy.com • www.stuppy.com



BOARD OF TRUSTEES Agenda Item

MEETING DATE: 6/12/23

MEETING TYPE:

- Regular Meeting
- Special Meeting

AGENDA ITEM TYPE:

- Action Item
- Non-Action Item

BOARD GOALS (check all that apply)

Academic Goals

- Academic Competitiveness
 - Early Literacy (HB3)
 - Early Math (HB3)
 - Other
- Career Certifications (HB3)

Operational Goals

- Promote Community/School Partnerships
- Fiscal Responsibility
- Safe and Secure Schools

TITLE: Discuss, Consider, and Take Any Necessary Action Regarding Proposal for Professional Services Between Jacob/Martin and MWISD.

RECOMMENDED ACTION: Approve the Proposal for Professional Services Between Jacob/Martin and MWISD.

BOARD POLICY/STATE REGULATION/LAW REFERENCE (if applicable): CV (LEGAL), 19 TAC 61.1040(a)(4), (e), (4) (D)

OVERVIEW:

A district shall designate one design professional to be the prime design professional for a capital improvement project and shall contractually engage the prime design professional to review and coordinate the design of the project. An architect or engineer required to be selected or designated under Government Code Chapter 2269 has full responsibility for complying with Occupations Code Chapter 1051 or 1001, as applicable.

An architectural plan or specification for any of the following may be prepared only by an architect:

- A new building having construction costs exceeding \$100,000 that is to be:
- Constructed and owned by a district; and
- Used for education, assembly, or office occupancy

FISCAL IMPACT: \$15,000 or less depending on hours (\$175.00 per hour)

ATTACHMENTS: BF (LOCAL)

DEPARTMENT(S) SUBMITTING FORM: Superintendent's office

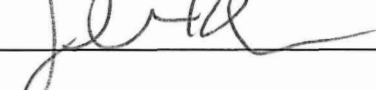
DEPARTMENT SIGNATURE/APPROVAL: 



INTEGRITY
EXCELLENCE
TRUST

PROPOSAL FOR PROFESSIONAL SERVICES

April 5, 2023

Client Information:

Dr. John Kuhn - Superintendent
Mineral Wells ISD
906 Southwest 5th Avenue
Mineral Wells, TX 76067
940.325.6404

Project Summary:

Architectural Third-Party
Consultants to MWISD for the
replacement of the
Horticulture Facility

Prepared by:

Tim Hopkins, AIA
Architect / Project Manager
JACOB|MARTIN

OVERVIEW OF SERVICES

Third Party Consultant

JACOB|MARTIN proposes to provide third party architectural consulting services to the Mineral Wells Independent School District for the purposes to review and consult with the District in the replacement of the Horticulture facility located on the High School Campus.

Review/ Consult:

JACOB|MARTIN proposes to provide the following consulting services in partnership with MWISD: Advise on the Selection of Contractor/ review Construction Documents and/ or Fabrication Drawings/ attend owner-contractor construction progress meetings/ review Pay Applications/ review Product Submittals/ review Proposed Change Requests/ review Testing and Inspection reports/ Warranty-Closeout-Training documents/ review Record Drawing Documents.

COMPENSATION

JACOB|MARTIN will complete the services listed above for a fixed fee of \$15,000 or hourly per the attached rate sheet.

Best Regards,

Tim Hopkins

Tim Hopkins, AIA



3465 Curry Lane
Abilene, TX 79606
325.695.1070

908 S. Main Street, Suite 100
Boerne, TX 78006
325.695.1070

4920 S. Loop 289, Suite 104
Lubbock, TX 79414
806.368.6375

1925 Fort Worth Highway
Weatherford, TX 76086
817.594.9880



INTEGRITY
EXCELLENCE
TRUST

FEES FOR PROFESSIONAL SERVICES

ENGINEERING SERVICES

Senior Principal Engineer	\$ 225.00
Principal Engineer	200.00
Registered Professional Engineer - 1	185.00
Registered Professional Engineer - 2	150.00
Engineer-in-Training (E.I.T.)	120.00
Engineering Technician - 1	120.00
Engineering Technician - 2	110.00
CAD Draftsman - 1	100.00
CAD Draftsman - 2	85.00
Engineering / Architectural Intern	60.00

ARCHITECTURAL SERVICES

Principal Architect	\$ 200.00
Licensed Architect - 1	175.00
Licensed Architect - 2	150.00
Licensed Interior Designer	115.00
Architectural Associate	110.00

ANCILLARY SERVICES

Environmental Scientist	\$ 120.00
Environmental Technician	75.00
GIS Technician - 1	120.00
GIS Technician - 2	90.00
Senior Land Man	100.00
Clerical - 1	90.00
Clerical - 2	75.00



3465 Curry Lane
Abilene, TX 79606
325.695.1070

908 S. Main Street, Suite 100
Boerne, TX 78006
325.695.1070

4920 S. Loop 289, Suite 104
Lubbock, TX 79414
806.368.6375

1925 Fort Worth Highway
Weatherford, TX 76086
817.594.9880



INTEGRITY
EXCELLENCE
TRUST

SURVEYING SERVICES

Principal Surveyor	\$ 175.00
Registered Professional Land Surveyor	160.00
Surveyor-in-Training (S.I.T.)	110.00
1-Man Crew	100.00
General Overtime (Weekends, Holidays or before 8 am or after 5 pm)	125.00
2-Man Crew	150.00
General Overtime (Weekends, Holidays or before 8 am or after 5 pm)	175.00
3-Man Crew	175.00
General Overtime (Weekends, Holidays or before 8 am or after 5 pm)	200.00
GPS Equipment	75.00
Robotic Total Station	60.00
Vehicle Charge (perday) plus IRS rate per mile	50.00

FIELD SERVICES

Resident Project Representative - 1	\$ 100.00
General Overtime (Weekends, Holidays or before 8 am or after 5 pm)	120.00
Resident Project Representative - 2	80.00
General Overtime (Weekends, Holidays or before 8 am or after 5 pm)	100.00
Licensed Water/Wastewater Operator (A/B)	90.00
Licensed Water/Wastewater Operator (C/D)	75.00
Vehicle Charge (perday) plus IRS rate per mile	50.00

A FACTOR OF 1.1 SHALL BE APPLIED TO THE FOLLOWING

1. Actual cost of subsistence and lodging
2. Actual cost of postage and shipping fees
3. Actual cost of materials required for the project used in surveying, drafting and associated activities
4. Actual cost of special tests and services of special consultants, if required

Effective 1/1/2023



3465 Curry Lane
Abilene, TX 79606
325.695.1070

908 S. Main Street, Suite 100
Boerne, TX 78006
325.695.1070

4920 S. Loop 289, Suite 104
Lubbock, TX 79414
806.368.6375

1925 Fort Worth Highway
Weatherford, TX 76086
817.594.9880



BOARD OF TRUSTEES Agenda Item

MEETING DATE: June 12, 2023

MEETING TYPE:

- Regular Meeting
- Special Meeting

AGENDA ITEM TYPE:

- Action Item
- Non-Action Item

BOARD GOALS (check all that apply)

Academic Goals

- Academic Competitiveness
 - Early Literacy (HB3)
 - Early Math (HB3)
 - Other
- Career Certifications (HB3)

Operational Goals

- Promote Community/School Partnerships
- Fiscal Responsibility
- Safe and Secure Schools

TITLE: Discuss, consider, and take any necessary action regarding a waiver is for staff development in place of student instruction for up to 2,100 minutes during the 2023-24 school year.

RECOMMENDED ACTION: It is recommended to approve the waiver as presented.

BOARD POLICY/STATE REGULATION/LAW REFERENCE (if applicable):

OVERVIEW:

According to TEA, "The Staff Development Minutes Waiver provides for a maximum of 2,100 total waiver minutes to use for professional development for districts and charter schools that provide operational and instructional minutes."

" This waiver allows the district and charter schools to train staff on various educational strategies designed to improve student performance in lieu of student instruction during the school year."

The following professional dates would be utilized in place of student instruction:

October 6, 2023

November 10, 2023

January 19, 2024

March 1, 2024

Adjustments will be made if the board makes changes during the 2023-2024 school year.

FISCAL IMPACT: ADA - Operational Expenses

ATTACHMENTS: _____

DEPARTMENT(S) SUBMITTING FORM: Curriculum, Instruction, & Assessment

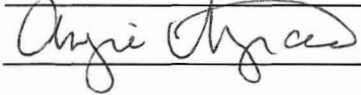
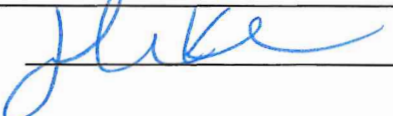
DEPARTMENT SIGNATURE/APPROVAL:  



BOARD OF TRUSTEES Agenda Item

MEETING DATE: 6/12/23

MEETING TYPE:

- Regular Meeting
- Special Meeting

AGENDA ITEM TYPE:

- Action Item
- Non-Action Item

BOARD GOALS (check all that apply)

Academic Goals

- Academic Competitiveness
 - Early Literacy (HB3)
 - Early Math (HB3)
 - Other
- Career Certifications (HB3)

Operational Goals

- Promote Community/School Partnerships
- Fiscal Responsibility
- Safe and Secure Schools

TITLE: Discuss, Consider, and Take Any Necessary Action Regarding MWISD Entering into an Agreement with the Region 11 Education Service Center for a Variety of Educational Services

RECOMMENDED ACTION: It is recommended that the school board approve the services contract with the Region 11 Education Service Center

BOARD POLICY/STATE REGULATION/LAW REFERENCE (if applicable):

OVERVIEW:

The Region 11 Education Service Center provides many services that assist the school district in complying with federal and state law, providing appropriate educational options for children, supporting instruction, supporting technology utilization, among many other aspects of education.

FISCAL IMPACT: 94,771.91

ATTACHMENTS: Services Contract and Associated Documents

DEPARTMENT(S) SUBMITTING FORM: Superintendent's Office

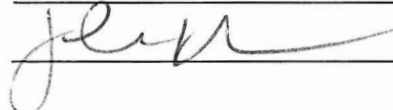
DEPARTMENT SIGNATURE/APPROVAL: 



1451 S. Cherry Lane
White Settlement, TX 76108

MINERAL WELLS ISD Contract Summary Report

Last Year Enrollment: 3352

<u>Contract</u>	<u>Lock Date</u>	<u>Enroll Start</u>	<u>Enroll End</u>	<u>Total</u>
Comprehensive Services Basic Contract	05/04/2023	09/01/2023	08/31/2024	\$650.00
DMAC Solutions	05/04/2023	09/01/2023	08/31/2024	\$21,665.80
HR Systems	05/04/2023	09/01/2023	08/31/2024	\$9,040.95
Instructional Solutions and Support	05/04/2023	09/01/2023	08/31/2024	\$29,468.16
OnDataSuite	05/04/2023	09/01/2023	08/31/2024	\$5,800.00
Technology Services	05/04/2023	09/01/2023	08/31/2024	\$5,000.00
TEKS Resource System	05/17/2023	09/01/2023	08/31/2024	\$18,055.00
TSDS (PEIMS, TIMS, UID, Core Collections)	05/04/2023	09/01/2023	08/31/2024	\$5,092.00
				\$94,771.91

Each party paying for the performance of governmental functions or services must make those payments from current revenues available to the paying party.

Signature of Board President or Designee

Date Approved by Board of Trustees

Signature of Superintendent or Designee

Date

Designated District Contact

E-mail of District Contact

Please fax or e-mail to:
Education Service Center Region 11
Atten: Dr. Clyde W. Steelman, Jr.
1451 S. Cherry Lane
White Settlement, Texas 76108
Fax (817) 740-7675
clydes@esc11.net

For additional information, contact:
Dr. Clyde W. Steelman, Jr.
(817) 740-3630
clydes@esc11.net

ESC Region 11 Executive Director Signature

EDUCATION SERVICE CENTER
REGION 11

1451 S. Cherry Lane
 White Settlement, TX 76108

MINERAL WELLS ISD Contract Summary Report

Last Year Enrollment: 3352

<u>Contract</u>	<u>Lock Date</u>	<u>Enroll Start</u>	<u>Enroll End</u>	<u>Total</u>
Comprehensive Services Basic Contract	05/04/2023	09/01/2023	08/31/2024	\$650.00
DMAC Solutions	05/04/2023	09/01/2023	08/31/2024	\$21,665.80
HR Systems	05/04/2023	09/01/2023	08/31/2024	\$9,040.95
Instructional Solutions and Support	05/04/2023	09/01/2023	08/31/2024	\$29,468.16
OnDataSuite	05/04/2023	09/01/2023	08/31/2024	\$5,800.00
Technology Services	05/04/2023	09/01/2023	08/31/2024	\$5,000.00
TSDS (PEIMS, TIMS, UID, Core Collections)	05/04/2023	09/01/2023	08/31/2024	\$5,092.00
				\$76,716.91

Each party paying for the performance of governmental functions or services must make those payments from current revenues available to the paying party.

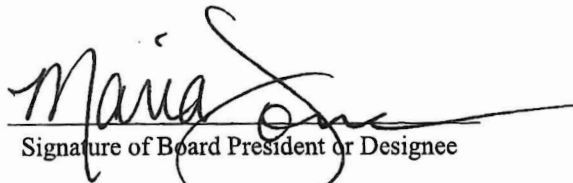
 Signature of Board President or Designee

5-8-23
 Date Approved by Board of Trustees

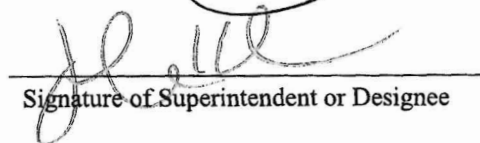
 Signature of Superintendent or Designee

5-19-23
 Date

John Kuhn
 Designated District Contact

jkuhn@mwisd.net
 E-mail of District Contact

Please fax or e-mail to:
 Education Service Center Region 11
 Atten: Dr. Clyde W. Steelman, Jr.
 1451 S. Cherry Lane
 White Settlement, Texas 76108
 Fax (817) 740-7675
 clydes@esc11.net

For additional information, contact:
 Dr. Clyde W. Steelman, Jr.
 (817) 740-3630
 clydes@esc11.net

 ESC Region 11 Executive Director Signature



BOARD OF TRUSTEES Agenda Item

MEETING DATE: 6/12/23

MEETING TYPE:

- Regular Meeting
- Special Meeting

AGENDA ITEM TYPE:

- Action Item
- Non-Action Item

BOARD GOALS (check all that apply)

Academic Goals

- Academic Competitiveness
 - Early Literacy (HB3)
 - Early Math (HB3)
 - Other
- Career Certifications (HB3)

Operational Goals

- Promote Community/School Partnerships
- Fiscal Responsibility
- Safe and Secure Schools

TITLE: Discuss Proposed Board Review of LOCAL policies (Discussion Item Only)

RECOMMENDED ACTION: None

BOARD POLICY/STATE REGULATION/LAW REFERENCE (if applicable): BF (LOCAL)

OVERVIEW:

Local policies are adopted by trustees at regular or special meetings. Local policies become effective upon Board adoption or at a future date designated by the Board. A regular review of adopted local policies is a good idea to ensure that Board members are familiar with existing policies. A legal review of the MWISD policy manual was conducted by the Texas Association of School Boards a few years ago and found that the MWISD board policy manual is legal and appropriate. A review by the Board of Trustees would have a different intent--to ensure that local policies as adopted by this or past boards continue to meet the needs of the District, per the judgment of the current Board of Trustees.

FISCAL IMPACT: none

ATTACHMENTS: BF (LOCAL)

DEPARTMENT(S) SUBMITTING FORM: Superintendent's office

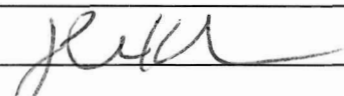
DEPARTMENT SIGNATURE/APPROVAL: 

Within the context of current law, the District shall be guided by Board-adopted written policies that are given appropriate distribution and are accessible to staff members, parents, students, and community residents.

Organization

Legally referenced policies contain provisions from federal and state statutes and regulations, case law, and other legal authority that together form the framework for local decision making and implementation. These policies are binding on the District until the cited provisions are repealed, revised, or superseded by legislative, regulatory, or judicial action.

Legally referenced policies are not adopted by the Board.

At each policy code the legally referenced policy and the Board-adopted local policy must be read together to further a full understanding of a topic.

Terms

The terms "Trustee" and "Board member" are used interchangeably in the local policy manual. Both terms are intended to reflect all the duties and obligations of the office.

[See AB for District name terminology.]

Harmony with Law

Newly enacted law is applicable when effective. No policy or regulation, or any portion thereof, shall be operative if it is found to be in conflict with applicable law.

Severability

If any portion of a policy or its application to any person or circumstance is found to be invalid, that invalidity shall not affect other provisions or applications of policy that can be given effect without the invalid provision or application; and to this end the provisions of this policy manual are declared to be severable.

Policy Development

Policies and policy amendments may be initiated by the Superintendent, Board members, school personnel, or community citizens, but generally shall be recommended for the Board's consideration by the Superintendent.

Official Policy Manual

The Board shall designate one copy of the local policy manual as the official policy manual of the District. The official copy shall be kept in the central administration office, and the Superintendent shall be responsible for its accuracy and integrity and shall maintain a historical record of the District's policy manual.

Adoption and Amendment

Local policies may be adopted or amended by a majority of the Board at any regular or special meeting, provided that Board members have had advance written notice of the proposed change and that it has been placed on the agenda for such meeting.

BOARD POLICIES

BF
(LOCAL)

TASB Localized
Updates

Local policies become effective upon Board adoption or at a future date designated by the Board at the time of adoption.

After Board review of legally referenced policies and adoption of local policies, the new material shall be incorporated into the official policy manual and into other localized policy manuals maintained by the District. If discrepancies occur between different copies of the manual, the version contained in the official policy manual shall be regarded as authoritative.



BOARD OF TRUSTEES Agenda Item

MEETING DATE: June 12, 2023

MEETING TYPE:

- Regular Meeting
- Special Meeting

AGENDA ITEM TYPE:

- Action Item
- Non-Action Item

BOARD GOALS (check all that apply)

Academic Goals

- Academic Competitiveness
 - Early Literacy (HB3)
 - Early Math (HB3)
 - Other
- Career Certifications (HB3)

Operational Goals

- Promote Community/School Partnerships
- Fiscal Responsibility
- Safe and Secure Schools

TITLE: Consider, Discuss, and Take Action on the 2023-2024 Compensation Plan

RECOMMENDED ACTION: It is recommended that the 2023-2024 Compensation Plan be approved as presented.

BOARD POLICY/STATE REGULATION/LAW REFERENCE (if applicable): Board Policy DEA(LEGAL), DEA(LOCAL)

OVERVIEW:

The Mineral Wells Independent School District Compensation Plan describes wage and salary structures, stipends, benefits, and incentives and supports district goals for hiring and retaining qualified employees. The Board shall review and approve the Compensation Plan to be used by the District. Each job title within the plan is compensated based on the qualifications, duties, and market value of the position.

FISCAL IMPACT: Approx. \$32,000,000

ATTACHMENTS: Compensation Plan

DEPARTMENT(S) SUBMITTING FORM: Assistant Superintendent/Human Resources

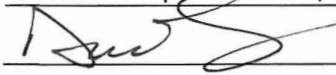
DEPARTMENT SIGNATURE/APPROVAL:  

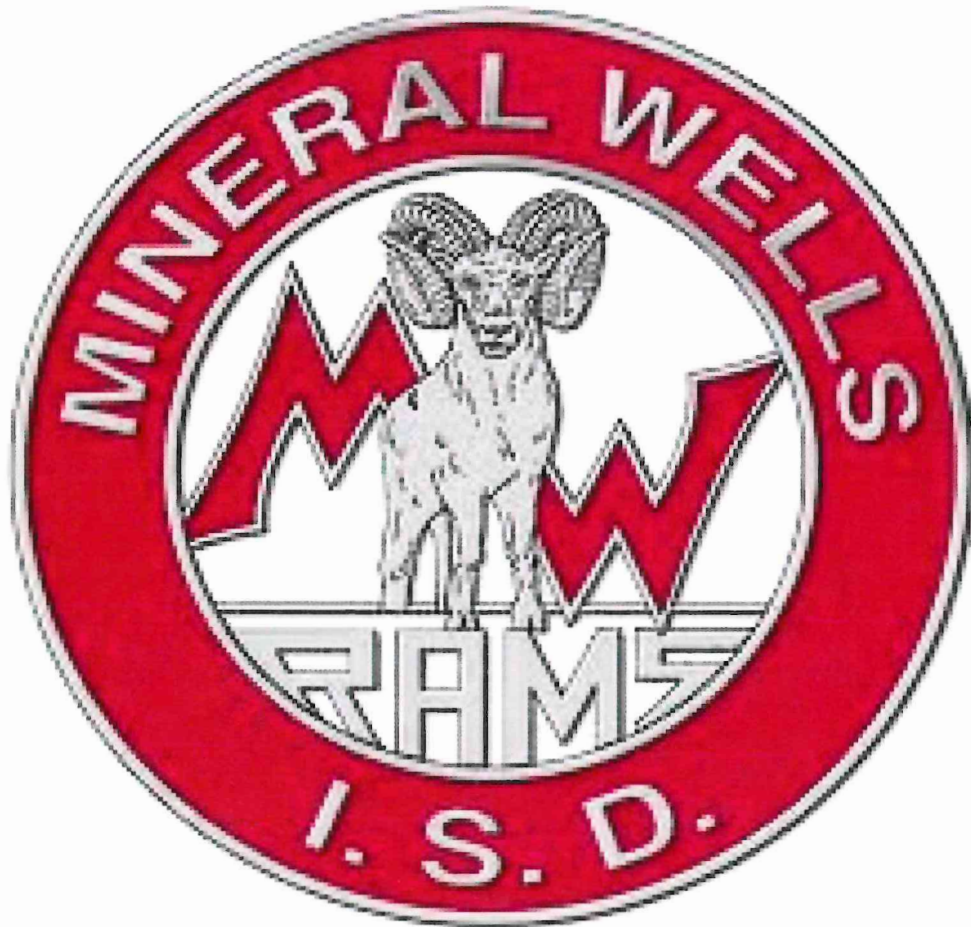

Compensation Plan 2023-2024

MWISD Human Resources Department
906 SW 5th Ave.
Mineral Wells, Texas 76067
940-325-6404

An Equal Opportunity Employer

Available online at:
www.mwisd.net

Mineral Wells ISD
2022-2023 New Hire Guide for
Teachers, Librarians, and Nurses (RN)

Experience	10 Month Salary	11 Month Salary	12 Month Salary
0	\$45,000	\$49,945	\$54,643
1	\$45,730	\$50,755	\$55,529
2	\$46,440	\$51,543	\$56,391
3	\$47,170	\$52,354	\$57,278
4	\$48,690	\$54,041	\$59,124
5	\$50,220	\$55,739	\$60,981
6	\$51,750	\$57,437	\$62,839
7	\$53,170	\$59,013	\$64,564
8	\$54,510	\$60,500	\$66,191
9	\$55,780	\$61,910	\$67,733
10	\$56,970	\$63,230	\$69,178
11	\$58,110	\$64,496	\$70,562
12	\$59,190	\$65,694	\$71,874
13	\$60,190	\$66,804	\$73,088
14	\$61,150	\$67,870	\$74,254
15	\$62,050	\$68,869	\$75,346
16	\$62,910	\$69,823	\$76,391
17	\$63,710	\$70,711	\$77,362
18	\$64,480	\$71,566	\$78,297
19	\$65,200	\$72,365	\$79,171
20	\$65,880	\$73,120	\$79,997
21	\$66,180	\$73,453	\$80,361
22	\$66,480	\$73,785	\$80,726
23	\$66,780	\$74,118	\$81,090
24	\$67,080	\$74,451	\$81,454
25	\$67,380	\$74,784	\$81,819
26+	* See Below	* See Below	* See Below

\$1,000 General Master's Degree Stipend

The salaries listed above are based on 10-month employment for the 2023-2024 school year. Salary plans are determined on an annual basis and salary advancement is not guaranteed. Pay increases are based on the annual pay raise budget approved by the Board of Trustees which will be based off the original TASB model, excluding District of Innovation adjustments.

* \$300 Raise Every MWISD Year After Step 25

Mineral Wells ISD
2023-2024 New Hire Guide for
Teachers, Librarians, and Nurses (RN)

Base Salary Range

10-Month Salary Range Minimum: \$45,000

10-Month Salary Range Maximum: \$67,380

\$1,000 General Master's Degree Stipend

\$300 Raise Every MWISD Year After Step 25

The salaries listed above are based on 10-month employment for the 2023-2024 school year. Salary plans are determined on an annual basis and salary advancement is not guaranteed. Pay increases are based on the annual pay raise budget approved by the Board of Trustees which will be based off the original TASB model, excluding District of Innovation adjustments.

Salaries are determined individually with consideration for job-related experience and credentials.

Administrative Pay Plan

Mineral Wells ISD

2023-2024

Pay Grade	Minimum	Midpoint	Maximum
1	\$308.76	\$376.54	\$444.32
2	\$328.70	\$400.86	\$473.01
3	\$353.78	\$431.43	\$509.09
4	\$385.71	\$470.38	\$555.05
5	\$438.15	\$527.90	\$617.64
6	\$489.66	\$589.95	\$690.24
7	\$556.65	\$670.67	\$784.68
8	\$617.15	\$743.56	\$869.97

Job Title	Days	Pay Grade	Minimum	Midpoint	Maximum
Campus Administration					
Assistant Principal, ES	185	1	\$57,120.60	\$69,659.90	\$82,199.20
Assistant Principal, JH	185	2	\$60,809.50	\$74,159.10	\$87,506.85
Dean of Students, JH	185	2	\$60,809.50	\$74,159.10	\$87,506.85
Assistant Principal, HS	185	3	\$65,449.30	\$79,814.55	\$94,181.65
Principal, DAEP	185	4	\$71,356.35	\$87,020.30	\$102,684.25
Principal, ES	189	4	\$72,899.19	\$88,901.82	\$104,904.45
Principal, JH	193	5	\$84,562.95	\$101,884.70	\$119,204.52
Principal, HS	193	6	\$94,504.38	\$113,860.35	\$133,216.32
District Services					
Coordinator, Public Relations	193	1	\$59,590.68	\$72,672.22	\$85,753.76
Director, Maintenance	193	2	\$63,439.10	\$77,365.98	\$91,290.93
Director, Food Service	193	3	\$68,279.54	\$83,265.99	\$98,254.37
Director, Transportation	193	3	\$68,279.54	\$83,265.99	\$98,254.37
Executive Director, Counseling/Assessment	193	4	\$74,442.03	\$90,783.34	\$107,124.65
Executive Director, Special Programs	193	4	\$74,442.03	\$90,783.34	\$107,124.65
Director, Special Education	193	5	\$84,562.95	\$101,884.70	\$119,204.52
Director, Technology	193	5	\$84,562.95	\$101,884.70	\$119,204.52
Executive Director, Curriculum/Instruction	193	5	\$84,562.95	\$101,884.70	\$119,204.52
Director, Athletics	193	6	\$94,504.38	\$113,860.35	\$133,216.32
Chief Financial Officer	193	7	\$107,433.45	\$129,439.31	\$151,443.24
Deputy Superintendent	193	8	\$119,109.95	\$143,507.08	\$167,904.21

Professional Pay Plan

Mineral Wells ISD

2023-2024

Pay Grade	Minimum	Midpoint	Maximum
1	\$275.71	\$336.23	\$396.76
2	\$325.72	\$397.22	\$468.72
3	\$357.16	\$435.57	\$513.97
4	\$407.56	\$497.02	\$586.49

Job Title	Days	Pay Grade	Minimum	Midpoint	Maximum
Campus Support					
LSSP Trainee	177	1	\$48,800.67	\$59,512.71	\$70,226.52
Occupational Therapist Asst	166	1	\$45,767.86	\$55,814.18	\$65,862.16

Speech Therapist Asst	166	1	\$45,767.86	\$55,814.18	\$65,862.16
Network Manager	193	1	\$53,212.03	\$64,892.39	\$76,574.68
BASE Coordinator	177	2	\$57,652.44	\$70,307.94	\$82,963.44
Coordinator, Autism	166	2	\$54,069.52	\$65,938.52	\$77,807.52
Counselor, ES	181	2	\$58,955.32	\$71,896.82	\$84,838.32
Counselor, JH	185	2	\$60,258.20	\$73,485.70	\$86,713.20
Counselor, HS	185	2	\$60,258.20	\$73,485.70	\$86,713.20
Diagnostician	177	2	\$57,652.44	\$70,307.94	\$82,963.44
LSSP	177	2	\$57,652.44	\$70,307.94	\$82,963.44
Speech Therapist	166	2	\$54,069.52	\$65,938.52	\$77,807.52
Occupational Therapist	166	3	\$59,288.56	\$72,304.62	\$85,319.02
Physical Therapist	166	4	\$67,654.96	\$82,505.32	\$97,357.34

Clerical Paraprofessional Pay Plan

Mineral Wells ISD

2023-2024

Pay Grade	Minimum	Midpoint	Maximum
1	\$11.39	\$15.39	\$19.08
2	\$11.79	\$15.72	\$19.65
3	\$14.12	\$17.65	\$21.18
4	\$15.18	\$18.98	\$22.78
5	\$18.29	\$22.30	\$26.31
6	\$20.84	\$25.41	\$32.78
7	\$25.00	\$30.49	\$35.98

Job Title	Days	Hours	Pay Grade	Minimum	Midpoint	Maximum
Campus Paraprofessional						
Bilingual Aide	166	7.5	1	\$14,178.81	\$19,160.55	\$23,759.08
Classroom Teacher Aide	166	7.5	1	\$14,178.81	\$19,160.55	\$23,759.08
Computer Lab Aide	166	7.5	1	\$14,178.81	\$19,160.55	\$23,759.08
ESL Aide	166	7.5	1	\$14,178.81	\$19,160.55	\$23,759.08
SPED Aide - General/Resource	166	7.5	1	\$14,178.81	\$19,160.55	\$23,759.08
Library Aide	166	7.5	2	\$14,678.55	\$19,571.40	\$24,464.25
SPED Aide - Self Contained	166	7.5	2	\$14,678.55	\$19,571.40	\$24,464.25
Campus Clerical						
Attendance Clerk	166	7.5	2	\$14,678.55	\$19,571.40	\$24,464.25
Office Clerk	166	7.5	2	\$14,678.55	\$19,571.40	\$24,464.25
Secretary, General	181	7.5	2	\$16,004.93	\$21,339.90	\$26,674.88
Secretary, General	185	7.5	2	\$16,358.63	\$21,811.50	\$27,264.38
Bookkeeper	181	7.5	4	\$20,612.28	\$25,765.35	\$30,918.42
PEIMS Clerk, ES	189	7.5	4	\$21,523.32	\$26,904.15	\$32,284.98
PEIMS Clerk, JH	189	7.5	4	\$21,523.32	\$26,904.15	\$32,284.98
Secretary, ES Principal	189	7.5	4	\$21,523.32	\$26,904.15	\$32,284.98
Secretary, JH Principal	189	7.5	4	\$21,523.32	\$26,904.15	\$32,284.98
Nurse (LVN)	166	7.5	4	\$18,904.08	\$23,630.10	\$28,356.12
PEIMS Clerk, HS	193	7.5	5	\$26,468.99	\$32,279.25	\$38,089.52
Secretary, HS Principal	193	7.5	5	\$26,468.99	\$32,279.25	\$38,089.52
Coordinator, Go Center	177	7.5	6	\$27,660.06	\$33,731.78	\$43,513.99

District Clerical/Support						
SPED PEIMS/Records Clerk	181	7.5	3	\$19,167.90	\$23,959.88	\$28,751.85
Receptionist	193	7.5	4	\$21,978.84	\$27,473.55	\$32,968.26
Secretary, Transportation Director	189	7.5	5	\$25,920.41	\$31,610.25	\$37,300.10
Secretary, Director	193	7.5	5	\$26,468.99	\$32,279.25	\$38,089.52
Accountant	193	7.5	6	\$30,160.40	\$36,780.98	\$47,447.46
Payroll Clerk	193	7.5	6	\$30,160.40	\$36,780.98	\$47,447.46
Purchasing Clerk	193	7.5	6	\$30,160.40	\$36,780.98	\$47,447.46
Secretary, Assistant Superintendent	193	7.5	6	\$30,160.40	\$36,780.98	\$47,447.46
Technology Support	193	7.5	6	\$30,160.40	\$36,780.98	\$47,447.46
PEIMS Coordinator	193	7.5	7	\$36,190.11	\$44,134.28	\$52,078.44
Secretary, Superintendent	193	7.5	7	\$36,190.11	\$44,134.28	\$52,078.44
Technical Specialist	193	7.5	7	\$36,190.11	\$44,134.28	\$52,078.44

Auxiliary Pay Plan

Mineral Wells ISD

2023-2024

Pay Grade	Minimum	Midpoint	Maximum
1	\$10.98	\$13.73	\$16.48
2	\$13.89	\$17.36	\$20.83
3	\$16.10	\$20.12	\$24.14
4	\$21.55	\$26.28	\$31.01
5	\$25.96	\$31.66	\$37.36

Job Title	Days	Hours	Pay Grade	Minimum	Midpoint	Maximum
Food Services						
Cafeteria Worker	160	4	1	\$7,029.76	\$8,787.20	\$10,544.64
Cafeteria Worker	160	6	1	\$10,544.64	\$13,180.80	\$15,816.96
Cafeteria Worker	160	6.5	1	\$11,423.36	\$14,279.20	\$17,135.04
Cafeteria Worker	160	7	1	\$12,302.08	\$15,377.60	\$18,453.12
Cafeteria Manager	160	8	3	\$14,059.52	\$17,574.40	\$21,089.28
Security						
Security Officer	185	7.5	2	\$19,269.60	\$24,087.00	\$28,904.40
Maintenance						
Groundskeeper	210	8	2	\$23,331.84	\$29,164.80	\$34,997.76
Maintenance Worker	210	8	3	\$27,041.28	\$33,801.60	\$40,561.92
HVAC Mechanic	210	8	4	\$36,203.33	\$44,150.40	\$52,097.47
Plumber	210	8	4	\$36,203.33	\$44,150.40	\$52,097.47
Grounds Supervisor	210	8	5	\$43,614.82	\$53,188.80	\$62,762.78
Maintenance Supervisor	210	8	5	\$43,614.82	\$53,188.80	\$62,762.78
Transportation						
Bus Driver/Bus Aide	160	4	3	\$10,301.44	\$12,876.80	\$15,452.16
Bus Fueler/Driver	193	4	3	\$12,426.11	\$15,532.64	\$18,639.17
Vehicle Maintenance	193	8	5	\$40,084.09	\$48,883.04	\$57,681.99

Blended Rate Pay Plan

Mineral Wells ISD

2023-2024

Pay Grade	Minimum	Midpoint	Maximum
1	\$13.33	\$17.31	\$21.29

Job Title	Days	Hours	Pay Grade	Minimum	Midpoint	Maximum
Blended Transportation						
Campus Assignment + Driver/Aide	166	10	1	\$22,125.64	\$28,734.60	\$35,343.56

Crossing Guard Pay Plan

Mineral Wells ISD

2023-2024

Pay Grade	Rate
Hourly	\$20.00

Job Title	Days	Hours	Pay Grade	Rate
Campus Crossing Guard	Student Days	2	Hourly	\$20/Hr.

Substitute Pay Plan

Mineral Wells ISD

2023-2024

Job Title	Short Term	Long Term
Paraprofessional Position	\$100	\$105
Teacher Position (Non-degreed)	\$105	\$110

Teacher Position (Degreed)	\$110	\$115
Teacher Position (Long-term Certified)	NA	\$120

* Long-term is defined as after 10 consecutive days in the same position for the same person

Supplementary Pay Plan (Stipends)

Mineral Wells ISD

2023-2024

Category A	Range of Supplemental Pay	\$300 - \$1,000
Cashier (Cafeteria)		
Department Head		
HS Athletics Off-Season Coordinator		
JH Cross Country		
JH Athletics Coordinator		
JH Soccer		
JH Tennis		
Math		
Pest Control (CA)		
Pest Control (Tech)		
SLPA Mentor (1)		
SPED (Lead Teacher)		
Sunset (1)		
T-TESS Duties (Non-Administrator)		
Category B	Range of Supplemental Pay	\$1,001 - \$2,500
Head Librarian		
Head Nurse		
HS Athletics Academic Coordinator		
HS Athletics Equipment Coordinator		
JH Basketball Coach		
JH Football Coach		
JH Track Coach		
JH Cheer Sponsor		
JH Volleyball Coach		
NEHS		
NHS		

Reading Specialist
 SLPA (0-2 years exp.)
 SLPA Mentor (2+)
 SPED Lead Diagnostician
 SPED Skills and Behavior Class Para
 Speech Therapy Assistant
 Speech Therapy Supervisor
 Sports Medicine 1,2 (Trainers)
 Student Council Sponsor (HS)
 Summer Camp Director (Athletics)
 Sunset (2)
 Sup't Benefits
 Teacher Academic Leader

Supplementary Pay Plan (Stipends) - Con't

Mineral Wells ISD

2023-2024

Category B - Con't	Range of Supplemental Pay	\$1,001 - \$2,500
Yearbook (HS)		
Category C	Range of Supplemental Pay	\$2,501 - \$6,000
Band Assistant		
Bilingual		
Cafeteria Manager		
Director's Secretary (Dual Role)		
ESL/Bilingual/Parent Engagement Coordinator		
HS Baseball Assistant Coach		
HS Basketball Assistant Coach		
HS Choir		
HS Cross Country Assistant Coach		
HS Cross Country Head Coach		
HS Football Assistant Coach		
HS Golf Head Coach		
HS Powerlifting Assistant Coach		
HS Powerlifting Head Coach		
HS Soccer Assistant Coach		
HS Soccer Head Coach		
HS Softball Assistant Coach		
HS Tennis Head Coach		
HS Theater Arts		
HS Track Assistant Coach		
HS Volleyball Assistant Coach		
JH Choir		
SLPA (3+ years exp)		
Technical Specialist		

Testing Coordinator

Category D	Range of Supplemental Pay	\$6,001 - \$12,000
------------	---------------------------	--------------------

Athletic Facilities Coordinator

Athletic Trainer (Assistant)

Athletic Trainer (Head)

Autism Coordinator

Band (Head)

CTE Coordinator

CTE (AG)

HS Baseball Head Coach

HS Basketball Head Coach

HS Football Defensive Coordinator

HS Football Offensive Coordinator

Supplementary Pay Plan (Stipends) - Con't

Mineral Wells ISD

2023-2024

Category D - Con't	Range of Supplemental Pay	\$6,001 - \$12,000
--------------------	---------------------------	--------------------

HS Football Special Teams Coordinator

HS Cheer Sponsor

HS Drill Team Sponsor

HS Softball Head Coach

HS Track Head Coach

HS Volleyball Head Coach

Maintenance Supervisor

Multi-Classroom Leader

		23-24
# Emp	3%	Raise Cost
5	2,090	10448.99
1	2,225	2224.77
1	2,225	2224.77
3	2,394	7183.31
1	2,611	2610.61
3	2,667	8001.16
1	3,057	3056.54
1	3,416	3415.81
1	2,180	2180.17
2	2,321	4641.96
1	2,498	2497.98
1	2,498	2497.98
1	2,724	2723.50
1	2,724	2723.50
1	3,057	3056.54
1	3,057	3056.54
1	3,057	3056.54
1	3,416	3415.81
1	3,883	3883.18
1	4,305	4305.21
0	1,785	0.00
0	1,674	0.00

3	1,674	5023.28
1	1,947	1946.77
1	2,109	2109.24
1	1,978	1978.16
3	2,157	6470.71
1	2,205	2204.57
1	2,205	2204.57
6	2,109	12655.43
4	2,109	8436.95
4	1,978	7912.62
2	2,169	4338.28
0	2,475	0.00
56		132485.45

# Emp	3%	23-24 Raise Cost
5	575	2874.08
24	575	13795.60
7	575	4023.72
1	575	574.82
9	575	5173.35
1	587	587.14
30	587	17614.26
		0.00
0	587	0.00
4	587	2348.57
1	640	640.20
4	654	2617.38
3	773	2318.88
1	807	807.12
1	807	807.12
1	807	807.12
3	807	2421.37
1	709	708.90
1	968	968.38
1	968	968.38
1	1,012	1011.95

1	719	718.80
1	824	824.21
1	948	948.31
4	968	3873.51
1	1,103	1103.43
1	1,103	1103.43
0	1,103	0.00
1	1,103	1103.43
4	1,103	4413.72
1	1,324	1324.03
1	1,324	1324.03
2	1,324	2648.06

2	264	527.23
11	395	4349.66
12	428	5140.51
4	461	1845.31
5	527	2636.16

1	723	722.61
---	-----	--------

4	875	3499.78
9	1,014	9126.43
1	1,325	1324.51
1	1,325	1324.51
1	1,596	1595.66
1	1,596	1595.66

19	386	7339.78
0	466	0.00
0	1,466	0.00
188		121481.11

10	862	8620.38
----	-----	---------



BOARD OF TRUSTEES Agenda Item

MEETING DATE: 6/13/23

MEETING TYPE:

- Regular Meeting
- Special Meeting

AGENDA ITEM TYPE:

- Action Item
- Non-Action Item

BOARD GOALS (check all that apply)

Academic Goals

- Academic Competitiveness
 - Early Literacy (HB3)
 - Early Math (HB3)
 - Other
- Career Certifications (HB3)

Operational Goals

- Promote Community/School Partnerships
- Fiscal Responsibility
- Safe and Secure Schools

TITLE: Discuss, Consider, and Take Any Necessary Action Regarding Chromebook Purchase for the 2024-2025 School Year

RECOMMENDED ACTION: It is recommended that the purchase of Chromebooks for the incoming 7th grade class of 2024-2025 be approved as presented.

BOARD POLICY/STATE REGULATION/LAW REFERENCE (if applicable): CH(LOCAL)

OVERVIEW:

We are scheduled to purchase Chromebooks each year for the incoming 7th grade class with a goal of them using their assigned Chromebook for their junior high and high school career. This request to purchase is being made much earlier than usual to take advantage of remaining ESSER3 funding. This Acer model was recently released and would be the model we would normally purchase during the spring; therefore, its expiration date fits into our device lifecycle plan. Acer allows us to start the warranty date upon deployment; therefore, early arrival of the devices will not diminish the initial warranty period of one year. Google licensing and zipper bag cases are included for each device.

FISCAL IMPACT: \$86,883.50

ATTACHMENTS: CDW-G Quote NKQK196

DEPARTMENT(S) SUBMITTING FORM: Technology

DEPARTMENT SIGNATURE/APPROVAL: Justin A. Lascsak

Digitally signed by Justin A. Lascsak
Date: 2023.06.07 14:40:08 -05'00'



Thank you for choosing CDW. We have received your quote.

Hardware Software Services IT Solutions Brands Research Hub

Review and Complete Purchase

JUSTIN LASCSAK,

Thank you for considering CDW•G for your technology needs. The details of your quote are below. **If you are an eProcurement or single sign on customer, please log into your system to access the CDW site.** You can search for your quote to retrieve and transfer back into your system for processing.

For all other customers, click below to convert your quote to an order.

Convert Quote to Order

ACCOUNT MANAGER NOTES: Updated!

QUOTE #	QUOTE DATE	QUOTE REFERENCE	CUSTOMER #	GRAND TOTAL
NKQK196	6/7/2023	NKQK196	3711862	\$86,883.50

QUOTE DETAILS

ITEM	QTY	CDW#	UNIT PRICE	EXT. PRICE
Acer Chromebook 511 C736 - 11.6" - Celeron N100 - 4 GB RAM - 32 GB eMMC - U Mfg. Part#: NX.KD4AA.002 Contract: TIPS 230105 Tech Solutions, Products, and Services (230105)	275	7304981	\$261.94	\$72,033.50
Google Chrome Education Upgrade Mfg. Part#: CROS-SW-DIS-EDU-NEW Electronic distribution - NO MEDIA Contract: TIPS 230105 Tech Solutions, Products, and Services (230105)	275	5988499	\$31.00	\$8,525.00
MAXCases Explorer 4 Work-In Case w Pocket - notebook carrying case Mfg. Part#: MC-EB4P-11-BLK Contract: TIPS 230105 Tech Solutions, Products, and Services (230105)	275	6109931	\$23.00	\$6,325.00

SUBTOTAL	\$86,883.50
SHIPPING	\$0.00
SALES TAX	\$0.00
GRAND TOTAL	\$86,883.50

PURCHASER BILLING INFO	DELIVER TO
Billing Address: MINERAL WELLS ISD ACCTS PAYABLE 906 SW 5TH AVE MINERAL WELLS, TX 76067-8445 Phone: (940) 325-6404 Payment Terms: NET 30 Days-Govt/Ed	Shipping Address: MINERAL WELLS ISD JUSTIN LASCSAK 906 SW 5TH AVE MINERAL WELLS, TX 76067-8445 Phone: (940) 325-6404 Shipping Method: Please remit payments to:

CDW Government
75 Remittance Drive
Suite 1515
Chicago, IL 60675-1515



Sales Contact Info

Laura Clark | (877) 325-6205 | laurcla@cdwg.com

Need Help?



My Account



Support



Call 800.800.4239

[About Us](#) | [Privacy Policy](#) | [Terms and Conditions](#)

This order is subject to CDW's Terms and Conditions of Sales and Service Projects at
<http://www.cdwg.com/content/terms-conditions/product-sales.aspx>

For more information, contact a CDW account manager

© 2023 CDW•G LLC, 200 N. Milwaukee Avenue, Vernon Hills, IL 60061 | 800.808.4239



BOARD OF TRUSTEES
Agenda Item

MEETING DATE: 6/12/23

MEETING TYPE:

- Regular Meeting
- Special Meeting

AGENDA ITEM TYPE:

- Action Item
- Non-Action Item

BOARD GOALS (check all that apply)

Academic Goals

- Academic Competitiveness
 - Early Literacy (HB3)
 - Early Math (HB3)
 - Other
- Career Certifications (HB3)

Operational Goals

- Promote Community/School Partnerships
- Fiscal Responsibility
- Safe and Secure Schools

TITLE: Discuss, Consider, and Take Any Necessary Action Regarding the Optional Flexible School Day

RECOMMENDED ACTION: It is recommended that the board approve the Optional Flexible School Day for MWISD Academy and MWHS as presented.

BOARD POLICY/STATE REGULATION/LAW REFERENCE (if applicable): Texas Education Code 29.0822, Optional Flexible School Day Program

OVERVIEW:

Optional Flexible School Day allows us to meet the needs of our students at risk of dropping out by flexing their day. They can come in mornings or afternoons and then be able to take care of other obligations the rest of the day.

Some of the groups this benefits:

- *Expecting parents
- *Parents
- *Those that have to work to help support their families
- *Those with medical conditions that prevent them from coming for the full day

FISCAL IMPACT: N/A

ATTACHMENTS: OFSD Application

DEPARTMENT(S) SUBMITTING FORM: MWHS

DEPARTMENT SIGNATURE/APPROVAL: *Shanna Spillers* *[Signature]*

Texas Education Agency



APPLICATION

Updated April 2022

Optional Flexible School Day Program (OFSDP)

2023-2024 School Year

ELIGIBLE APPLICANTS: The Texas Education Agency (TEA) will make available to eligible school districts and open-enrollment charter schools an application form that must be completed and submitted annually to the TEA for approval.

Definition of Program Provisions

Eligible Students

A student in any grade level is eligible to participate in an OFSDP authorized under the [TEC, §29.0822](#), if the student is:

- at risk of dropping out of school, as defined by the [TEC, §29.081](#),
- attending a campus implementing an approved innovative campus plan,
- attending a TEA-designated ECHS as defined by the [TEC, §29.908](#), P-TECH, or ICIA,
- attending a community-based dropout recovery education program, as defined by the [TEC, §29.081\(e-1\) or \(e-2\)](#), or
- not meeting attendance requirements under the [TEC, §25.092](#), resulting in denied credit for one or more classes in which the student has been enrolled.

AND

There must be an agreement in writing to the student's participation:

- by the student, if the student is over 18 years of age; or
- by the student and the student's parent or person standing in parental relation to the student, if the student is less than 18 years of age and not emancipated by marriage or court order.

Assessment

The student must take the required state assessments specified under the [TEC, §39.023](#), during the regularly scheduled assessment calendar.

Participation in University Interscholastic League (UIL)

A student enrolled in an OFSDP under the [TEC, §29.0822](#), may participate in a competition or other activity sanctioned or conducted under the authority of the University Interscholastic League (UIL) only if he or she meets all UIL eligibility criteria.

Attendance Credit

A student attending an OFSDP under the TEC, §29.0822, may be counted in average daily attendance (ADA) for purposes of funding under the TEC, Chapters 46, 48, and 49, only for the actual number of contact hours the student receives, not to exceed 720 hours or 43,200 minutes per 12-month period. **Students enrolled in the traditional program for part of the year and the OFSDP program for part of the year may not earn more than one ADA.**

Board Approval

The board of trustees of a school district must include the OFSDP as an item on a regular agenda for a board meeting. Board of trustees of a school district must discuss the progress of the program before approving the program and applying to operate an OFSDP (see Appendix Two).

Continuation or Revocation of Program Authorization

Applications are approved for a period of one (1) school year. Continuation of the approval for the OFSDP will be contingent on the demonstrated success of the program. Determination of success will include a review and analysis of data provided in the mandatory final progress report(s). The commissioner of education may revoke authorization for participation in the OFSDP after consideration of relevant factors, including performance of students participating in the program on assessment instruments required under the TEC, Chapter 39; the percentage of students participating in the program who graduate from high school; and other criteria agreed to in the application and adopted by the commissioner of education. A decision to revoke approval of the program by the commissioner of education is final and may not be appealed.

Reporting Requirements

Following approval of the application, the applicant may be required to submit progress reports based on criteria selected by the applicant and agreed to by the commissioner. When requested, reports will require applicants to disclose the overall progress of the students in the program, the number of students enrolled in the program (disaggregated by ethnicity, age, gender, and socioeconomic status), the number of students graduating from high school (disaggregated by ethnicity, age, gender, and socioeconomic status), and additional criteria selected by the applicant and agreed to by the commissioner. The TEA will provide notice to applicants and additional instructions for completion of reports at least 45 days before the date a report is due, or as soon as possible, in order to give school districts and charter schools adequate time to prepare and submit the reports to the TEA. The TEA may request additional reports as necessary to monitor and assess progress of students participating in the program.

Provisions of Agreement

Article I – Parties to Agreement

This agreement is entered into by and between the Texas Education Agency, an agency of the State of Texas, hereinafter referred to as the “TEA,” and

Mineral Wells ISD

(Legal Name of School District or Open-Enrollment Charter School)

located at

906 SW 5th Avenue, Mineral Wells, Texas 76067

(Physical Address)

hereinafter referred to as “district.”

Article II – Period of Agreement

The period of the agreement, as detailed by participating campus in **Appendix 5**, is for a maximum of one (1) school year plus an additional thirty (30) school days if the district is applying for credit recovery. **Note that the agreement term is subject to annual renewal.**

Article III – Purpose of Agreement

The district must perform all the functions and duties set out in the agreement, the authorizing program statute, and applicable regulations.

Article IV – Reporting Requirements

The district may be required to submit progress reports based on criteria selected by the applicant and agreed to by the commissioner. The TEA may request additional reports as necessary to monitor and assess progress of students participating in the program.

Article V – General and Special Provisions to the Agreement

Attached hereto and made a part hereof by reference is each of the provisions indicated below with an “X” beside it:

- Appendix One, Assurances
- Appendix Two, Board Approval
- Appendix Three, Attendance and Compliance Procedures of Proposed Program (Attach PDF File)
- Appendix Four, Contact Sheet
- Appendix Five, Participating Campuses, Student Eligibility, and Period of Agreement (Attach Excel File)

Article VI – Application Process

- For questions or assistance regarding this application, email opflex@tea.texas.gov or call 512-463-9294.
- Applications should be submitted 30 days prior to the start of the program. Start date(s) on Appendix 5 should be at least thirty (30) days after the application is submitted.
- Applications submitted by July 15th should be approved by August 15th.
- Email the complete application and attachments to: opflex@tea.texas.gov.
- Email subject line should indicate: OFSDP Application - District Name, County District Number

Article VII – Agreement

AGREED and accepted on behalf of the school district or open-enrollment charter school to be effective on the earliest date written above by a person authorized to bind the district.

Typed Name Dr. John Kuhn _____ Authorized Signature _____
Typed Title Superintendent _____

Appendix One Assurances

The definition of terms of the application applies to this Appendix One, Assurances. The school district or open-enrollment charter school hereinafter called “district” does hereby certify and agree to the following conditions of the agreement.

Page limit: Submit no additional pages for Appendix One. All information requested must be included with this form.

The district agrees to enroll only eligible students to participate in an OFSDP authorized under this application. A student is eligible to participate in an OFSDP authorized under the TEC, §29.0822, if:

1. the student meets one of the following conditions:
 - the student is at risk of dropping out of school, as defined by the [TEC, §29.081](#); or
 - the student is attending a campus implementing an approved innovative campus plan; or
 - the student is attending a community-based dropout recovery education program, as defined by the [TEC, §29.081\(e-1\) or \(e-2\)](#); or
 - the student is attending a campus with an approved early college high school program designation as defined by the [TEC, §29.908](#); or
 - the student, as a result of attendance requirements under the [TEC, §25.092](#), will be denied credit for one or more classes in which the student has been enrolled.

and

2. there is an agreement in writing to the student’s participation
 - by the student, if the student is over 18 years of age; or
 - by the student and the student’s parent or person standing in parental relation to the student, if the student is less than 18 years of age and not emancipated by marriage or court order.

The district agrees:

1. to administer mandatory assessment instruments during the regular assessment cycle to students enrolled in OFSDPs;
2. to ensure all instructional materials and facilities are comparable or exceed the required standards for students in similar programs;
3. that the students participating in an OFSDP will not be isolated from other academic and vocational programs of the school district and that all students will have access to school counselors for pre- and post-entry counseling, academic or personal counseling, and career counseling;
4. to provide faculty and administrators with baccalaureate or advanced degrees, highly qualified staff, and certified teachers as required by 19 Texas Administrative Code §129.1027 for the program;
5. to adopt a policy that does not penalize students participating in an OFSDP in accordance with the 90% rule (TEC, §25.092[a]) or the 75% to 90% rule for class credit (TEC, §25.092[a-1]);
6. to adopt a policy to require students to attend regularly scheduled instruction for the OFSDP with penalties for nonattendance including filing truancy charges, if appropriate;
7. to track the number of minutes the student receives instruction each day and to comply with applicable sections of the [Student Attendance Accounting Handbook](#).

8. to comply with all reporting requirements established by the TEA;
9. not to discriminate based on disability, race, color, national origin, religion, or sex; and
10. to prohibit a student participating in an OFSDP from participating in a competition or other activity sanctioned or conducted under the authority of the UIL unless the student meets all UIL eligibility requirements.

AGREED and accepted terms and conditions of Appendix One on behalf of the school district or open-enrollment charter school by persons authorized to bind the district.

Maria Jones, Board President, 940-452-3432

Name, Title, and Telephone Number of School Board President

Signature of SchoolBoard President

Date

Dr. John Kuhn, Superintendent, 940-445-7037

Name, Title, and Telephone Number of District Superintendent or Charter School Chief Operations Officer

Signature of Person Authorized to Bind the District or Charter School

Date

Appendix Two Board Approval

The definition of terms of the application applies to this Appendix Two, Board Approval. The school district or open-enrollment charter school hereinafter called "district" does hereby certify and agree to the following conditions of the agreement.

Page limit: Submit no additional pages for Appendix Two. All information requested must be included with this form.

1. The board of trustees of the school district or the governing board of the open-enrollment charter school **agrees to include the OFSDP as an item on the agenda** concerning the proposed application.

2. The board of trustees of the school district or the governing board of the open-enrollment charter school must discuss the progress of the program before applying to operate an OFSDP.

The proposed OFSDP application was on the agenda and discussed at the board meeting conducted on:

Month: _____

Day: _____

Year: _____

Time: _____

Location: _____

Agreed and accepted on behalf of the school district or open-enrollment charter school by persons authorized to bind the district.

Maria Jones, Board President, 940-452-3432

Name, Title, and Telephone Number of School Board President

Signature of School Board President

Date

Dr. John Kuhn, Superintendent, 940-445-7037

Name, Title, and Telephone Number of District Superintendent or Charter School Chief Operations Officer

Signature of Person Authorized to Bind the District or Charter School

Date

Appendix Three

Attendance and Compliance Procedures of Proposed Program

The definition of terms of the application applies to this Appendix Three, Attendance and Compliance Procedures of Proposed Program. The school district or open-enrollment charter school hereinafter called “district” does hereby certify and agree to the following conditions of the agreement.

Page limit: Submit a separate PDF document to concisely provide the information below, labeled with the corresponding number, for Appendix Three. All information requested must be included with this form and should be reviewed by the District PEIMS Coordinator prior to submission.

1. Describe the program goals and objectives.
The program goal is to assist students that need a non-traditional school day in order to reach high school graduation and prevent dropouts.
2. Indicate the proposed schedule offered to students participating in the OFSDP, including days of the week and times.
The proposed schedule will operate from Monday through Thursday and have two sessions, one morning (8:00-12:00) and one afternoon session from (12:00-4:00).
3. Provide an outline of staff positions and resource personnel (teachers, administrators, counselors, support staff, etc.) associated with the program. Include contact hours each staff position will be obligated to the program.
One Teacher will be assigned all day to this group (8 hours). One administrator will be assigned to this group as their major duty (4-8 hours per day). A counselor and support staff will be on campus full time as well to assist students (up to 8 hours per day).
4. Describe the procedures for identifying students, including how the school confirms and documents student eligibility and obtaining student and parental consent for OFSDP participation.
Students will apply to join the program and their application will be reviewed by a committee made of an administrator, a counselor, and at least one teacher. Students will be admitted based on qualification, need, and space available. The student and the student's parent/guardian will agree in writing to participation in OFSDP if the student is less than 18 years of age and not emancipated by marriage or court order; or the student agrees in writing to participate if the student is 18 years of age or older, per Texas Administrative Code §129.1027 (b)(2).
5. Indicate the estimated number of OFSDP students that will be served per teacher.
15
6. **If** the OFSDP program will offer special education, career and technology education, pregnancy related services or bilingual education, indicate how services will be provided, the teacher certification standards in each program area, and how services will comply with the [Student Attendance Accounting Handbook](#).
Students will continue to receive services in special education, career and technology education, pregnancy related services and bilingual education. The students receive instruction from educators that are highly qualified in each program area. Career and technology course meet the required amount of time (53 minutes) per class. Special education and bilingual students both continue to receive services including annual meetings, monitoring, classroom and testing accommodations. Pregnancy related services will be provided as needed. Flexible day after delivering baby, parenting classes and connections with community services are provided to PRS students. If students receiving pregnancy related services are placed on CEHI, then they will be removed from the OFSDP attendance

accounting process.

7. OFSDP requires a teacher of record to record the actual number of students' instructional minutes on any given day. Explain the following:
- a. How the classroom teacher will verify the number of instructional minutes a student receives each day.
The classroom teacher will verify the number of minutes of instruction that a student receives each day by filling out a daily Contact Register provided by PIEMS. Teachers will keep track of the number of minutes students attend each day and certify the student's minutes with their signature each day.
 - b. How the district will make sure that minutes for students who did not attend a minimum of 45 minutes on a particular day are not reported for funding.
The district will make sure that minutes for students who did not attend a minimum of 53 minutes on a particular day are not reported. This process is documented in Skyward when the PIEMS coordinator adds the minutes in the OFSDP area. This data is entered at the end of each week when the Contact Register is turned in from each teacher.
 - c. How the district will ensure that students transferring from the traditional program (ADA Codes 0-6) to OFSDP (ADA Codes 7-8) will not generate more than one ADA in total for the school year and that students will not receive more than 10,800 minutes per course. It is recommended that the district apply the following formula to determine the maximum OFSDP minutes a student is eligible = (Calendar School Days - Traditional Days Present) x 240.
The district will make sure that students transferring from the traditional program to OFSDP will not generate more than one ADA by transferring students at the beginning of each six weeks. The campus PIEMS coordinator will make sure that they do not count double.
 - d. How the district will ensure that students are not coded in a traditional program on the same day that the student is accumulating OFSDP instructional minutes.
The district will ensure that all PEIMS personnel in charge of coding are trained in the proper way to document that students receive either traditional funding or OFSD funding, but not both for any particular day.
 - e. How the district will ensure that attendance practices and records comply with Sections 2.2.3 and 11.6 of the [Student Attendance Accounting Handbook](#).
The district will ensure that attendance practices and records comply with Sections 2.23 and 11.6 of the Student Attendance Accounting Handbook by using a paper data entry system and backing it up in Skyward. The campus PIEMS coordinator will enter the data at the end of each week to document the minutes each student attended for the week. Students will not receive more than 10,800 minutes per course.
 - f. How Student Detail Audit reports for the OFSDP track will be reviewed and certified each six-week attendance reporting period.
The Student Detail Audit reports for the OFSDP track will be reviewed and certified each six weeks by the PIEMS coordinator and the classroom teacher. There is an attendance form that each classroom teacher is required to sign for attendance accuracy.

NOTE: absences and days present do not exist in the OFSDP

8. If eligible OFSDP students participate in a credit recovery program offered in the summer, funding is limited to the attendance necessary for the student to recover class credit. Please describe how attendance will be monitored to ensure additional minutes are not reported for funding. The classroom teacher will verify the number of minutes of instruction that a student receives each day by filling out a daily Contact Register provided by PIEMS. Teachers will keep track of the number of minutes students attend each day and certify the student's minutes with their signature each day.
9. **If** students are attending a community-based dropout recovery education program offered online as defined by TEC, §29.081 (e-2), must include the following:
- a. Describe the curriculum credentials, certifications, or other course offerings that relate directly to employment opportunities in the state.
Does not Apply to MWISD
 - b. Describe the individual learning plan or process used to monitor each student's progress.
Does not Apply to MWISD
 - c. Indicate how students will be served by an academic coach and local advocate.
Does not Apply to MWISD
 - d. Indicate the date of the month that monthly student progress reports will be provided to the student's school district.
Does not Apply to MWISD
 - e. Describe the educational software utilized and explain how the software will track and certify the number of instructional minutes each student receives each day.
Does not Apply to MWISD

Appendix Four Contact(s) Sheet

The definition of terms of the application applies to this Appendix Four, Contact(s) Sheet. The school district or open-enrollment charter school hereinafter called “district” does hereby certify and agree to the following conditions of the agreement.

Page limit: Submit no additional pages for Appendix Four. All information requested must be included with this form.

District Contact(s) for the Application

District/Charter School Superintendent:	Dr. John Kuhn, Superintendent
Mailing Address:	906 SW 5 th Avenue
City, State, Zip Code:	Mineral Wells, TX 76067
Telephone Number:	940-445-7037
Email Address:	jkuhn@mwisd.net

District PEIMS Coordinator:	Rena Hearn
Email Address:	rhearn@mwisd.net

OFSDP Contact Name:	Shanna Spillers
Email Address:	sspillers@mwisd.net

OFSDP Contact Name:	Stephanie Johnston
Email Address:	sjohnston@mwisd.net

NOTE: Most of the contact for the approved OFSDP is done via email. A valid email address(es) must be submitted on this form. Provide the full name(s) of the person(s) who is (are) the email contact(s) to ensure that the TEA has accurate information.

Appendix Five
Participating Campuses, Student Eligibility, and Period of Agreement

The definition of terms of the application applies to this Appendix Five, Participating Campuses, Student Eligibility, and Period of Agreement. The school district or open-enrollment charter school hereinafter called “district” does hereby certify and agree to the following conditions of the agreement.

Page limit: Submit no additional pages for Appendix Five. All information requested must be included with this template and submitted in a separate Excel file.

Download and complete Appendix 5, which can be found on the [OFSDP webpage](#) under the *Applications and Templates* section.

Once completed, email the following to OPFLEX@tea.texas.gov:

1. The application (in PDF file format)
2. Appendix Three (in PDF file format)
3. Appendix Five (in MS Excel file format)

***All file names should include the district/charter school’s name**

Optional Flexible School Day Program (OFSDP) - Appendix 5

Insert 6-Digit District Number

School Year 2023-2024

<p>Students may not be reported with more than one ADA in total on the 42400 Basic Attendance Collection 3 and 42500 Flex Attendance in collections 3 and 4</p>	<p>Eligibility Designation 1 = TEC §29.081 At-Risk Students 2 = TEC §25.092 Minimum Attendance 3 = TEC §29.908 Early College High School 4 = TEC §39A.107 Campus Turnaround Plan 5 = Credit Recovery** 6 = TEC §29.081(e-1) Campus Dropout Recovery 7 = TEC §29.081(e-2) Online Dropout Recovery</p>	<p>School Year Period of Agreement Reported in TSDS PEIMS Summer Collection 3</p> <p>Program start date must be 30 days after application submission.</p> <p>Program end date must not exceed the last day of the regular school calendar.</p>	<p>Summer Period of Agreement Reported in TSDS PEIMS Extended Collec</p> <p>**Credit Recovery - Designation</p> <p>Summer period of agreement should exceed 30 days or extend past July 31</p>
---	--	--	---

Nine Digit District and Campus Number	Campus Name	Eligibility Designation							Estimated Students Participating	Program Start Date	Program End Date	Proposed Days: SUMTWTWHS	Minutes Offered Per Day	Summer Program Start Date	Summer Program End Date	Proposed Days: SUMTWTWHS
		1	2	3	4	5	6	7								
182903001	MINERAL WELLS H S	1	2					15			M,T,W,TH	240				
182903002	MINERAL WELLS ACADEMY	1	2				6	50			M,T,W,TH	240				
000000000																
000000000																
000000000																
000000000																

Optional Flexible School Day Program (OFSDP) - Appendix 5

Insert 6-Digit District Number

School Year 2023-2024

<p>Students may not be reported with more than one ADA in total on the 42400 Basic Attendance Collection 3 and 42500 Flex Attendance in collections 3 and 4</p>	<p>Eligibility Designation 1 = TEC §29.081 At-Risk Students 2 = TEC §25.092 Minimum Attendance 3 = TEC §29.908 Early College High School 4 = TEC §39A.107 Campus Turnaround Plan 5 = Credit Recovery** 6 = TEC §29.081(e-1) Campus Dropout Recovery 7 = TEC §29.081(e-2) Online Dropout Recovery</p>	<p>School Year Period of Agreement Reported in TSDS PEIMS Summer Collection 3</p> <p>Program start date must be 30 days after application submission.</p> <p>Program end date must not exceed the last day of the regular school calendar.</p>	<p>Summer Period of Agreement Reported in TSDS PEIMS Extended Collection 3</p> <p>**Credit Recovery - Designation</p> <p>Summer period of agreement should exceed 30 days or extend past July 31st</p>
---	--	--	---

Nine Digit District and Campus Number	Campus Name	1	2	3	4	5	6	7	Estimated Students Participating	Program Start Date	Program End Date	Proposed Days: SUMTWTWFS	Minutes Offered Per Day	Summer Program Start Date	Summer Program End Date	Proposed Days: SUMTWTWFS
000000000																
000000000																
000000000																
000000000																
000000000																
000000000																

Optional Flexible School Day Program (OFSDP) - Appendix 5

Insert 6-Digit District Number

School Year 2023-2024

<p>Students may not be reported with more than one ADA in total on the 42400 Basic Attendance Collection 3 and 42500 Flex Attendance in collections 3 and 4</p>	<p>Eligibility Designation 1 = TEC §29.081 At-Risk Students 2 = TEC §25.092 Minimum Attendance 3 = TEC §29.908 Early College High School 4 = TEC §39A.107 Campus Turnaround Plan 5 = Credit Recovery** 6 = TEC §29.081(e-1) Campus Dropout Recovery 7 = TEC §29.081(e-2) Online Dropout Recovery</p>	<p>School Year Period of Agreement Reported in TSDS PEIMS Summer Collection 3</p> <p>Program start date must be 30 days after application submission.</p> <p>Program end date must not exceed the last day of the regular school calendar.</p>	<p>Summer Period of Agreement Reported in TSDS PEIMS Extended Collec</p> <p>**Credit Recovery - Designation</p> <p>Summer period of agreement should exceed 30 days or extend past July :</p>
---	--	--	--

Nine Digit District and Campus Number	Campus Name	1	2	3	4	5	6	7	Estimated Students Participating	Program Start Date	Program End Date	Proposed Days: SUMTWTWTHFS	Minutes Offered Per Day	Summer Program Start Date	Summer Program End Date	Proposed Days: SUMTWTWTHFS
000000000																
000000000																
000000000																
000000000																
000000000																
000000000																

Optional Flexible School Day Program (OFSDP) - Appendix 5

Insert 6-Digit District Number

School Year 2023-2024

<p>Students may not be reported with more than one ADA in total on the 42400 Basic Attendance Collection 3 and 42500 Flex Attendance in collections 3 and 4</p>	<p>Eligibility Designation 1 = TEC §29.081 At-Risk Students 2 = TEC §25.092 Minimum Attendance 3 = TEC §29.908 Early College High School 4 = TEC §39A.107 Campus Turnaround Plan 5 = Credit Recovery** 6 = TEC §29.081(e-1) Campus Dropout Recovery 7 = TEC §29.081(e-2) Online Dropout Recovery</p>	<p>School Year Period of Agreement Reported in TSDS PEIMS Summer Collection 3 Program start date must be 30 days after application submission. Program end date must not exceed the last day of the regular school calendar.</p>	<p>Summer Period of Agreement Reported in TSDS PEIMS Extended Collec **Credit Recovery - Designation Summer period of agreement should exceed 30 days or extend past July 31</p>
---	--	--	--

Nine Digit District and Campus Number	Campus Name	1	2	3	4	5	6	7	Estimated Students Participating	Program Start Date	Program End Date	Proposed Days: SUMTWTWTHFS	Minutes Offered Per Day	Summer Program Start Date	Summer Program End Date	Proposed Days: SUMTWTWTHFS	
000000000																	
000000000																	
000000000																	
000000000																	
000000000																	
000000000																	

Optional Flexible School Day Program (OFSDP) - Appendix 5

Insert 6-Digit District Number

School Year 2023-2024

<p>Students may not be reported with more than one ADA in total on the 42400 Basic Attendance Collection 3 and 42500 Flex Attendance in collections 3 and 4</p>	<p>Eligibility Designation 1 = TEC §29.081 At-Risk Students 2 = TEC §25.092 Minimum Attendance 3 = TEC §29.908 Early College High School 4 = TEC §39A.107 Campus Turnaround Plan 5 = Credit Recovery** 6 = TEC §29.081(e-1) Campus Dropout Recovery 7 = TEC §29.081(e-2) Online Dropout Recovery</p>	<p>School Year Period of Agreement Reported in TSDS PEIMS Summer Collection 3</p> <p>Program start date must be 30 days after application submission.</p> <p>Program end date must not exceed the last day of the regular school calendar.</p>	<p>Summer Period of Agreement Reported in TSDS PEIMS Extended Collec</p> <p>**Credit Recovery - Designation</p> <p>Summer period of agreement should exceed 30 days or extend past July :</p>
---	--	--	--

Nine Digit District and Campus Number	Campus Name	Eligibility Designation							Estimated Students Participating	Program Start Date	Program End Date	Proposed Days: SUMTWTWHS	Minutes Offered Per Day	Summer Program Start Date	Summer Program End Date	Proposed Days: SUMTWTWHS
		1	2	3	4	5	6	7								
000000000																
000000000																
000000000																
000000000																
000000000																
000000000																

Optional Flexible School Day Program (OFSDP) - Appendix 5

Insert 6-Digit District Number

School Year 2023-2024

<p>Students may not be reported with more than one ADA in total on the 42400 Basic Attendance Collection 3 and 42500 Flex Attendance in collections 3 and 4</p>	<p>Eligibility Designation 1 = TEC §29.081 At-Risk Students 2 = TEC §25.092 Minimum Attendance 3 = TEC §29.908 Early College High School 4 = TEC §39A.107 Campus Turnaround Plan 5 = Credit Recovery** 6 = TEC §29.081(e-1) Campus Dropout Recovery 7 = TEC §29.081(e-2) Online Dropout Recovery</p>	<p>School Year Period of Agreement Reported in TSDS PEIMS Summer Collection 3</p> <p>Program start date must be 30 days after application submission.</p> <p>Program end date must not exceed the last day of the regular school calendar.</p>	<p>Summer Period of Agreement Reported in TSDS PEIMS Extended Collec</p> <p>**Credit Recovery - Designation</p> <p>Summer period of agreement should exceed 30 days or extend past July 31</p>
---	--	--	---

Nine Digit District and Campus Number	Campus Name	1	2	3	4	5	6	7	Estimated Students Participating	Program Start Date	Program End Date	Proposed Days: SUMTWTWFS	Minutes Offered Per Day	Summer Program Start Date	Summer Program End Date	Proposed Days: SUMTWTWFS
000000000																
000000000																
000000000																
000000000																
000000000																
000000000																

Optional Flexible School Day Program (OFSDP) - Appendix 5

Insert 6-Digit District Number

School Year 2023-2024

Students may not be reported with more than one ADA in total on the 42400 Basic Attendance Collection 3 and 42500 Flex Attendance in collections 3 and 4

- Eligibility Designation**
- 1 = TEC §29.081 At-Risk Students
 - 2 = TEC §25.092 Minimum Attendance
 - 3 = TEC §29.908 Early College High School
 - 4 = TEC §39A.107 Campus Turnaround Plan
 - 5 = Credit Recovery**
 - 6 = TEC §29.081(e-1) Campus Dropout Recovery
 - 7 = TEC §29.081(e-2) Online Dropout Recovery

School Year Period of Agreement
Reported in TSDS PEIMS Summer Collection 3

Program start date must be 30 days after application submission.

Program end date must not exceed the last day of the regular school calendar.

Summer Period of Agreement
Reported in TSDS PEIMS Extended Collection 3

****Credit Recovery - Designation**

Summer period of agreement should exceed 30 days or extend past July 31st

Nine Digit District and Campus Number	Campus Name	Eligibility Designation							Estimated Students Participating	Program Start Date	Program End Date	Proposed Days: SUMTWTWFS	Minutes Offered Per Day	Summer Program Start Date	Summer Program End Date	Proposed Days: SUMTWTWFS
		1	2	3	4	5	6	7								
00000000																
00000000																
00000000																
00000000																
00000000																
00000000																

Optional Flexible School Day Program (OFSDP) - Appendix 5

Insert 6-Digit District Number

School Year 2023-2024

<p>Students may not be reported with more than one ADA in total on the 42400 Basic Attendance Collection 3 and 42500 Flex Attendance in collections 3 and 4</p>	<p>Eligibility Designation 1 = TEC §29.081 At-Risk Students 2 = TEC §25.092 Minimum Attendance 3 = TEC §29.908 Early College High School 4 = TEC §39A.107 Campus Turnaround Plan 5 = Credit Recovery** 6 = TEC §29.081(e-1) Campus Dropout Recovery 7 = TEC §29.081(e-2) Online Dropout Recovery</p>	<p>School Year Period of Agreement Reported in TSDS PEIMS Summer Collection 3</p> <p>Program start date must be 30 days after application submission.</p> <p>Program end date must not exceed the last day of the regular school calendar.</p>	<p>Summer Period of Agreement Reported in TSDS PEIMS Extended Collec</p> <p>**Credit Recovery - Designation</p> <p>Summer period of agreement should exceed 30 days or extend past July 31</p>
---	--	--	---

Nine Digit District and Campus Number	Campus Name	1	2	3	4	5	6	7	Estimated Students Participating	Program Start Date	Program End Date	Proposed Days: SUMTWTWFS	Minutes Offered Per Day	Summer Program Start Date	Summer Program End Date	Proposed Days: SUMTWTWFS	
000000000																	
000000000																	
000000000																	
000000000																	
000000000																	
000000000																	

Optional Flexible School Day Program (OFSDP) - Appendix 5

Insert 6-Digit District Number

School Year 2023-2024

<p>Students may not be reported with more than one ADA in total on the 42400 Basic Attendance Collection 3 and 42500 Flex Attendance in collections 3 and 4</p>	<p>Eligibility Designation 1 = TEC §29.081 At-Risk Students 2 = TEC §25.092 Minimum Attendance 3 = TEC §29.908 Early College High School 4 = TEC §39A.107 Campus Turnaround Plan 5 = Credit Recovery** 6 = TEC §29.081(e-1) Campus Dropout Recovery 7 = TEC §29.081(e-2) Online Dropout Recovery</p>	<p>School Year Period of Agreement Reported in TSDS PEIMS Summer Collection 3</p> <p>Program start date must be 30 days after application submission.</p> <p>Program end date must not exceed the last day of the regular school calendar.</p>	<p>Summer Period of Agreement Reported in TSDS PEIMS Extended Collec</p> <p>**Credit Recovery - Designation</p> <p>Summer period of agreement should exceed 30 days or extend past July 31</p>
---	--	--	---

Nine Digit District and Campus Number	Campus Name	1	2	3	4	5	6	7	Estimated Students Participating	Program Start Date	Program End Date	Proposed Days: SUMTWTWTHFS	Minutes Offered Per Day	Summer Program Start Date	Summer Program End Date	Proposed Days: SUMTWTWTHFS	
000000000																	
000000000																	
000000000																	
000000000																	
000000000																	
000000000																	



nt
:tion 4

15

I not
31st.

Minutes
Offered
Per Day



nt
:tion 4

15

I not
31st.

Minutes
Offered
Per Day



at
tion 4

5

I not
31st.

Minutes
Offered
Per Day



rt
:tion 4

15

I not
31st.

Minutes
Offered
Per Day



nt
:tion 4

15

I not
31st.

Minutes
Offered
Per Day



rt
:tion 4

5

I not
31st.

Minutes
Offered
Per Day



at
:tion 4

15

I not
31st.

Minutes
Offered
Per Day



rt
:tion 4
i 5
l not
31st.

Minutes
Offered
Per Day



nt
:tion 4

15

l not
31st.

Minutes
Offered
Per Day



BOARD OF TRUSTEES Agenda Item

MEETING DATE: 6/12/23

MEETING TYPE:

- Regular Meeting
- Special Meeting

AGENDA ITEM TYPE:

- Action Item
- Non-Action Item

BOARD GOALS (check all that apply)

Academic Goals

- Academic Competitiveness
 - Early Literacy (HB3)
 - Early Math (HB3)
 - Other
- Career Certifications (HB3)

Operational Goals

- Promote Community/School Partnerships
- Fiscal Responsibility
- Safe and Secure Schools

TITLE: Calendars for June and July 2023

RECOMMENDED ACTION: This item is for information only.

BOARD POLICY/STATE REGULATION/LAW REFERENCE (if applicable):

OVERVIEW:

See attached calendars

FISCAL IMPACT: N/A

ATTACHMENTS: June and July Calendars

DEPARTMENT(S) SUBMITTING FORM: Superintendent

DEPARTMENT SIGNATURE/APPROVAL: 

Mineral Wells Independent School District June 2023

Houston Elementary School • Lamar Elementary School • Mineral Wells Academy • Mineral Wells High School • Mineral Wells Jr. High • Travis Elementary School

Sunday	Monday	Tuesday	Wednesday	Thursday	Friday	Saturday
<p>Copy: Open Gym Girls Basketball 2 PM – 4 PM (Both Gyms)</p> <p style="text-align: right; font-size: 2em;">28</p>	<p style="text-align: right; font-size: 2em;">29</p>	<p>Copy: Summer Workout 5/30/2023, 8 AM – 6/1/2023, 10 AM (High School)</p> <p>Copy: Cheer Camp 5/30/2023, 10 AM – 6/2/2023, 11 AM (Tarleton)</p> <p style="text-align: right; font-size: 2em;">30</p>	<p>Copy: Summer Workout 5/30/2023, 8 AM – 6/1/2023, 10 AM (High School)</p> <p>Copy: Ram Baseball Camp 5/31/2023, 9 AM – 6/1/2023, 12 PM (Pratt Field)</p> <p>Copy: Softball Camp 9 AM – 12 PM (Kessler Field)</p> <p>Copy: Cheer Camp 5/30/2023, 10 AM – 6/2/2023, 11 AM (Tarleton)</p> <p style="text-align: right; font-size: 2em;">31</p>	<p>Copy: Summer Workout 5/30/2023, 8 AM – 6/1/2023, 10 AM (High School)</p> <p>Copy: Ram Baseball Camp 5/31/2023, 9 AM – 6/1/2023, 12 PM (Pratt Field)</p> <p>Copy: Cheer Camp 5/30/2023, 10 AM – 6/2/2023, 11 AM (Tarleton)</p> <p style="text-align: right; font-size: 2em;">1</p>	<p>Copy: Cheer Camp 5/30/2023, 10 AM – 6/2/2023, 11 AM (Tarleton)</p> <p style="text-align: right; font-size: 2em;">2</p>	<p>Copy: SAT testing 7:30 AM – 2:30 PM (HS)</p> <p style="text-align: right; font-size: 2em;">3</p>
<p>Copy: Open Gym Girls Basketball 2 PM – 4 PM (Both Gyms)</p> <p style="text-align: right; font-size: 2em;">4</p>	<p>CHEER CAMP 5 6/5/2023, 8 AM – 6/8/2023, 4 PM (Tarleton State University (1333 W Washington St, Stephenville, TX 76401))</p> <p>Copy: Summer School -Two Sessions 8 AM – 4 PM (High School)</p>	<p>CHEER CAMP 6 6/5/2023, 8 AM – 6/8/2023, 4 PM (Tarleton State University (1333 W Washington St, Stephenville, TX 76401))</p> <p>Copy: Summer School -Two Sessions 8 AM – 4 PM (High School)</p>	<p>CHEER CAMP 7 6/5/2023, 8 AM – 6/8/2023, 4 PM (Tarleton State University (1333 W Washington St, Stephenville, TX 76401))</p> <p>Copy: Summer School -Two Sessions 8 AM – 4 PM (High School)</p> <p style="text-align: right; font-size: 2em;">TODAY</p>	<p>CHEER CAMP 8 6/5/2023, 8 AM – 6/8/2023, 4 PM (Tarleton State University (1333 W Washington St, Stephenville, TX 76401))</p> <p>Copy: Summer School -Two Sessions 8 AM – 4 PM (High School)</p>	<p>Soccer Camp Boys and Girls 9 9:30 AM – 11 AM (Ram Stadium)</p> <p>Copy: 50year Club Reunion (Hoops Basketball Scholarship fundraiser) Meeting and reunion 12 PM – 10 PM (Auditorium, Cafeteria, Foyer and Main gym)</p>	<p>Copy: MWHS 10 50 Year Club Reunion and new class induction 7 AM – 3 PM (Auditorium, Cafeteria and Foyer)</p> <p>Copy: ACT testing 7:30 AM – 2:30 PM (HS)</p>

Sunday	Monday	Tuesday	Wednesday	Thursday	Friday	Saturday
		<p>Copy: Summer Workout 6/6/2023, 8 AM – 6/8/2023, 10 AM (High School)</p>	<p>Copy: Summer Workout 6/6/2023, 8 AM – 6/8/2023, 10 AM (High School)</p>	<p>Copy: Summer Workout 6/6/2023, 8 AM – 6/8/2023, 10 AM (High School)</p> <p>Copy: Soccer Camp Boys and Girls 10:30 AM – 12:30 PM (Ram Stadium)</p>		
<p>Copy: Open Gym Girls Basketball 11 2 PM – 4 PM (Both Gyms)</p>	<p>Copy: Summer School -Two Sessions 12 8 AM – 4 PM (High School)</p> <p>Copy: Tennis Camp Boys & Girls 3rd -9th 6/12/2023, 8 AM – 6/14/2023, 10 AM (High School Tennis Courts)</p>	<p>Copy: Summer School -Two Sessions 13 8 AM – 4 PM (High School)</p> <p>Copy: Summer Workout 6/13/2023, 8 AM – 6/14/2023, 8 AM (High School)</p> <p>Copy: Tennis Camp Boys & Girls 3rd -9th 6/12/2023, 8 AM – 6/14/2023, 10 AM (High School Tennis Courts)</p>	<p>Copy: Summer School -Two Sessions 14 8 AM – 4 PM (High School)</p> <p>Copy: Summer Workout 6/13/2023, 8 AM – 6/14/2023, 8 AM (High School)</p> <p>Copy: Summer Workout 6/14/2023, 8 AM – 6/15/2023, 8 AM (High School)</p> <p>Copy: Tennis Camp Boys & Girls 3rd -9th 6/12/2023, 8 AM – 6/14/2023, 10 AM (High School Tennis Courts)</p>	<p>Copy: Summer School -Two Sessions 15 8 AM – 4 PM (High School)</p> <p>Copy: Summer Workout 6/14/2023, 8 AM – 6/15/2023, 8 AM (High School)</p> <p>Copy: Summer Workout 6/15/2023, 8 AM – 6/16/2023, 8 AM (High School)</p>	<p>Copy: Summer Workout 16 6/15/2023, 8 AM – 6/16/2023, 8 AM (High School)</p>	<p>Copy: Crazy Karate Tournament 17 7 AM – 2 PM (High School Main Gym)</p>
<p>Copy: Open Gym Girls Basketball 18 2 PM – 4 PM (Both Gyms)</p>	<p>Copy: Summer School -Two Sessions 19 8 AM – 4 PM (High School)</p> <p>Copy: Rams Basketball Camp-</p>	<p>Copy: Summer School -Two Sessions 20 8 AM – 4 PM (High School)</p> <p>Copy: Summer Workout</p>	<p>Copy: Summer School -Two Sessions 21 8 AM – 4 PM (High School)</p> <p>Copy: Summer Workout</p>	<p>Copy: Summer School -Two Sessions 22 8 AM – 4 PM (High School)</p> <p>Copy: Summer Workout</p>	<p>Copy: Summer Workout 23 6/22/2023, 8 AM – 6/23/2023, 8 AM (High School)</p>	<p>24</p>

Sunday	Monday	Tuesday	Wednesday	Thursday	Friday	Saturday
	<p>PreK -6th 6/19/2023, 10:30 AM – 6/21/2023, 12:30 PM (Both Gyms)</p> <p>Copy: Lady Ram Basketball Camp-PreK -6th 6/19/2023, 1 PM – 6/21/2023, 3 PM (Both Gyms)</p>	<p>6/20/2023, 8 AM – 6/21/2023, 8 AM (High School)</p> <p>Copy: Rams Basketball Camp-PreK -6th 6/19/2023, 10:30 AM – 6/21/2023, 12:30 PM (Both Gyms)</p> <p>Copy: Lady Ram Basketball Camp-PreK -6th 6/19/2023, 1 PM – 6/21/2023, 3 PM (Both Gyms)</p>	<p>6/21/2023, 8 AM – 6/22/2023, 8 AM (High School)</p> <p>Copy: Summer Workout 6/20/2023, 8 AM – 6/21/2023, 8 AM (High School)</p> <p>Copy: Rams Basketball Camp-PreK -6th 6/19/2023, 10:30 AM – 6/21/2023, 12:30 PM (Both Gyms)</p> <p>Copy: Lady Ram Basketball Camp-PreK -6th 6/19/2023, 1 PM – 6/21/2023, 3 PM (Both Gyms)</p>	<p>6/21/2023, 8 AM – 6/22/2023, 8 AM (High School)</p> <p>Copy: Summer Workout 6/22/2023, 8 AM – 6/23/2023, 8 AM (High School)</p>		
<p>Copy: Open Gym Girls Basketball 2 PM – 4 PM (Both Gyms)</p> <p>25</p>	<p>Copy: EOC Summer Retesting 6/26/2023, 8 AM – 6/30/2023, 12 PM (HS)</p> <p>26</p>	<p>Copy: EOC Summer Retesting 6/26/2023, 8 AM – 6/30/2023, 12 PM (HS)</p> <p>27</p>	<p>Copy: EOC Summer Retesting 6/26/2023, 8 AM – 6/30/2023, 12 PM (HS)</p> <p>28</p>	<p>Copy: EOC Summer Retesting 6/26/2023, 8 AM – 6/30/2023, 12 PM (HS)</p> <p>29</p>	<p>Copy: EOC Summer Retesting 6/26/2023, 8 AM – 6/30/2023, 12 PM (HS)</p> <p>30</p>	<p>1</p>

<http://www.mwisd.net>

906 Southwest 5th Avenue, Mineral Wells, TX 76067
Phone: 940-325-6404 | Fax: 940-325-6378

Mineral Wells Independent School District July 2023

Houston Elementary School • Lamar Elementary School • Mineral Wells Academy • Mineral Wells High School • Mineral Wells Jr. High • Travis Elementary School

Sunday	Monday	Tuesday	Wednesday	Thursday	Friday	Saturday
Copy: Open Gym Girls Basketball 25 2 PM – 4 PM (Both Gyms)	Copy: EOC Summer Retesting 26 6/26/2023, 8 AM – 6/30/2023, 12 PM (HS)	Copy: EOC Summer Retesting 27 6/26/2023, 8 AM – 6/30/2023, 12 PM (HS)	Copy: EOC Summer Retesting 28 6/26/2023, 8 AM – 6/30/2023, 12 PM (HS)	Copy: EOC Summer Retesting 29 6/26/2023, 8 AM – 6/30/2023, 12 PM (HS)	Copy: EOC Summer Retesting 30 6/26/2023, 8 AM – 6/30/2023, 12 PM (HS)	1
Copy: Open Gym Girls Basketball 2 2 PM – 4 PM (Both Gyms)	3	4	5	6	7	8
Copy: Open Gym Girls Basketball 9 2 PM – 4 PM (Both Gyms)	10	Copy: Summer Workout 11 7/11/2023, 8 AM – 7/12/2023, 8 AM (High School)	Copy: Summer Workout 12 7/11/2023, 8 AM – 7/12/2023, 8 AM (High School)	Copy: Summer Workout 13 7/13/2023, 8 AM – 7/14/2023, 8 AM (High School)	Copy: Summer Workout 14 7/13/2023, 8 AM – 7/14/2023, 8 AM (High School)	15
Copy: Solar Car Challenge Group -Stop Over on route to California - Community invited 16	17	Copy: Summer Workout 18 7/18/2023, 8 AM – 7/19/2023, 8 AM (High School)	Copy: Summer Workout 19 7/19/2023, 8 AM – 7/20/2023, 8 AM (High School)	Copy: Summer Workout 20 7/19/2023, 8 AM – 7/20/2023, 8 AM (High School)	Copy: Summer Workout 21 7/20/2023, 8 AM – 7/21/2023, 8 AM (High School)	22

Sunday	Monday	Tuesday	Wednesday	Thursday	Friday	Saturday
<p>to come by and look at cars 11 AM – 1 PM (Ram Stadium Front Parking lot -Reserved lot)</p> <p>Copy: Open Gym Girls Basketball 2 PM – 4 PM (Both Gyms)</p>			<p>Copy: Summer Workout 7/18/2023, 8 AM – 7/19/2023, 8 AM (High School)</p>	<p>Copy: Summer Workout 7/20/2023, 8 AM – 7/21/2023, 8 AM (High School)</p>		
<p>Copy: Open Gym Girls Basketball 23 2 PM – 4 PM (Both Gyms)</p>	24	<p>Copy: Summer Workout 25 7/25/2023, 8 AM – 7/26/2023, 8 AM (High School)</p>	<p>Copy: New Teacher Training -DSC on Wednesday High School on Thursday 26 7/26/2023, 8 AM – 7/27/2023, 4:30 PM (High School Tiered Lecture Hall and A10 Lab)</p> <p>Copy: Summer Workout 7/26/2023, 8 AM – 7/27/2023, 8 AM (High School)</p> <p>Copy: Summer Workout 7/25/2023, 8 AM – 7/26/2023, 8 AM (High School)</p>	<p>Copy: New Teacher Training -DSC on Wednesday High School on Thursday 27 7/26/2023, 8 AM – 7/27/2023, 4:30 PM (High School Tiered Lecture Hall and A10 Lab)</p> <p>Copy: Summer Workout 7/27/2023, 8 AM – 7/28/2023, 8 AM (High School)</p> <p>Copy: Summer Workout 7/26/2023, 8 AM – 7/27/2023, 8 AM (High School)</p>	<p>Copy: Summer Workout 28 7/27/2023, 8 AM – 7/28/2023, 8 AM (High School)</p>	29
<p>Copy: Open Gym Girls Basketball 30 2 PM – 4 PM (Both Gyms)</p>	31	1	<p>Copy: Volleyball 2-A-days 2 8/2/2023 – 8/5/2023, 11:59 PM (High School)</p>	<p>Copy: Volleyball 2-A-days 3 8/2/2023 – 8/5/2023, 11:59 PM (High School)</p>	<p>Copy: Volleyball 2-A-days 4 8/2/2023 – 8/5/2023, 11:59 PM (High School)</p>	<p>Copy: Volleyball 2-A-days 5 8/2/2023 – 8/5/2023, 11:59 PM (High School)</p>