

# Chisholm School District School Board Meeting Agenda

Monday, January 10, 2022 at 5:00 PM  
Regular Meeting  
Chisholm School Board Room

I. Determination of Quorum and Call to Order	
A. Reorganization of the School Board	4
<b>Attachments:</b>	
2022 Reorganization Meeting	4
II. Public Comment:	
<p><b>Description:</b> Welcome to this meeting of the Board of Education Independent School District #695, Chisholm School District. We are extremely pleased that you have shown an interest in school district affairs by attending this meeting. The Board of Education allows public participation at its meeting, but at the same time has the responsibility for conducting its business in an orderly fashion. We will provide the audience with an opportunity to request to speak. We request that before you speak to announce your name. Each speaker will be allowed five minutes unless the time limit is waived by a majority of the board members present. At a public meeting of the board, no person shall orally initiate charges or complaints against individual employees of the district or challenge instructional materials used in the district. All such charges, if presented to the board directly, shall be referred to the Superintendent for investigation and report. We would also like to remind the public that the school board is not allowed to comment on your concerns. If there are no questions, we will open the public comment section of the board meeting.</p>	
III. Recognition of Guests and Visitors	
IV. Approve Agenda	
V. Approve Minutes	
A. Motion to approve the following minutes:	5
December 13, 2021, Regular Meeting	
December 13, 2021, Truth in Taxation	
December 23, 2021, Special Meeting	
<b>Attachments:</b>	
SBM 12/13/2021	5
Truth in Taxation 2021	9
2021 Audit Meeting	10
VI. Reports	

A. Superintendent's Report 11

VII. Correspondence

VIII. Consent Agenda

A. Motion to approve the Consent Agenda: 11

- A. Payrolls for the month of December - \$597,937.10
- B. Accounts payable for the month of December - \$436,609.32

C. Motion to approve the following policies that have been revised by MSBA/MASA. The revisions reflect federal and state statutory changes, recent court decisions, and similar sources.

- 1. #510.4 Chisholm Athletic and Non-Athletic Activity Fees
- 2. #513.1 Class Schedule Change Policy

**Attachments:**

December Payroll 11

ACFrOgBGvB69tCIPUP9xYr3-DHk2SNwhpH7khKEnhPKGstbp1f5w\_1D8k  
Z-8Lo-M6QPkR7wN0Kr8mUGlhthh6zjP5DGjInDy038nK5iiA9omhzAycj9L  
cNXxxFVY3Zc= 12

December AP 23

DOC010622 (1) 34

DOC010622 36

IX. Action Agenda

A. Motion to accept the resignation of Geoge Rajkovich, Chief Engineer, effective December 30, 2021. 38

**Attachments:**

GR Resignation 38

B. Motion to approve the posting, Chief Engineer, effective January 7, 2022.

C. Motion to accept the resignation of Elizabeth Carroll, as Yearbook Advisor, effective June 3, 2022. 39

**Attachments:**

EC Resignation YB Advisor 39

D. Motion to approve the posting of Yearbook Advisor, effective January 7, 2021.

E. Motion to rescind the contract between ISD 695 and Jennifer Rolle which the board approved on December 13, 2021.

F. Motion to approve the hiring of Jennifer Rolle as a 1.0, FTE Science teacher, effective January 24, 2022, through June 3, 2022.

G. Motion to approve MSBA Policy 491 as presented.

H. Motion to approve payment to Aim Electronics Inc. in the amount of \$6,596.00 for the purchase of the shot clock and light strips. 40

**Attachments:**

Aim Electronics 40

I. Motion to approve the BSN Sports Rewards Program for Chisholm Schools for the period of January 1, 2022, through December 31, 2024.	49
<b>Attachments:</b>	
BSN Sports Rewards Program	49
J. Motion to approve payments to Sourcewell Technology in the amounts of \$4,800.00 for Ongoing Advantage and \$1,750.00 for Consulting Services.	52
<b>Attachments:</b>	
Sourcewell	52
Sourcewell	53
K. Motion to adopt resolution to accept donations.	58
<b>Attachments:</b>	
December Donations (1)	58
X. Discussion	
A. COVID protocols/Omicron variant/masking policy	
XI. Information	
A. A. Enrollment Numbers	
XII. Adjourn	

## **ACTION:**

### **Board Reorganization Meeting Action Items**

1. Elect Chairperson
2. Elect Treasurer
3. Elect Clerk
4. Elect Officers pro tem Officers
5. Set Salaries for Chairperson/Directors
6. Approve the use of the signature plate
7. Set Date, Time and Place for Regular Board Meetings
8. Adopt Robert's Rules of Order
9. Appoint Representatives for:
  - a. Community Ed Advisory Board
  - b. Early Childhood Family Education Advisory Board
10. Appoint Standing Committees:
  - a. Budget/Construction Committee
  - b. Personnel Committee
  - c. Teacher Negotiations
  - d. Noncertified Negotiations
  - e. At-Will/Administrative Negotiations
  - f. Policy Committee
  - g. Collaborative Committee
  - h. Sports Complex Lease Committee
11. Determine Official District Depositories
12. Approve Broker Certificates
13. Designate Official Newspaper
14. Adopt new Federal milage rate

December 13, 2021

The Regular Meeting of the School Board, Independent School District No. 695, was called to order at 5:00 P.M. on November 22, 2021, in the Elementary Board Room. Members present: Directors Sever, Rice, Sauter, Lappi, Chair Rahja and Superintendent Norman  
Members Absent: Director Corradi-Simon who arrived at 5:11

**Public Comment:** Patrick Lauzen expressed his concern regarding the fall play. He was not happy about the dark content of the play and wished in the future the director would go in a different direction.

**Recognition of Guests and Visitors:** Marissa Pessenda expressed her need for an assistant cheer coach. Her numbers of participants have increased dramatically since she started but she is still only one coach. She would like an assistant to help grow the program.

#### APPROVE AGENDA

Moved by Director Lappi, supported by Director Sever to approve the December 13, 2021, agenda. Motion carried unanimously.

#### **Approve Minutes:**

Moved by Director Sauter, supported by Director Corradi-Simon to approve the minutes from the November 22, 2021, Regular Meeting. Motion carried unanimously.

#### SUPERINTENDENT REPORT

Superintendent Norman updated the board regarding the following: Snowshoe project, Detroit Diesel donated \$2,500 to Robotics Team, Safe Schools survey, Ingensa met with the Administration about the physical space around the school, Superintendent Norman would like to personally thank Rosie Marino for the donation of mittens to the Chisholm Schools, the Hibbing Business office sent out a survey to staff and retired employees, it was about 90% positive and we are needing some direction in the near future, Indian Education position was filled by an applicant and we are just waiting for the background to introduce him to the staff.

**Correspondence:** None

#### APPROVE CONSENT AGENDA

Moved by Director Rice supported by Director Corradi-Simon to approve the Consent Agenda which consists of the following for the Month of November: Payrolls for the month of November in the amount of \$602,802.11. Accounts payable for the month of November in the amount of \$635,465.76. Motion carried unanimously

**Action Agenda:**

**Personnel:**

HIRE BRADY BOEHM

Moved by Director Sauter supported by Director Sever to approve the hiring of Brady Boehm as the temporary Boy's Head Swim Coach for the 2021-2022 season. Motion carried unanimously

HIRE JENNIFER ROLLE

Moved by Director Lappi, supported by Director Corradi-Simon to approve the hiring of Jennifer Rolle as a long-term substitute, High School Science, effective January 24 through June 3, 2022. Motion carried unanimously. Time of hire: 5:21PM

HIRE ANDREW JUGOVICH

Moved by Director Corradi-Simon, supported by Director Sever to approve the hiring of Andrew Jugovich as a long-term substitute, High School Science, starting January 17, 2022, through approximately April 19, 2022. Motion carried unanimously. Time of hire 5:23 PM

ACCEPT LEAVE OF ABSENCE OF JENNIFER ROLLE

Moved by Director Sever, supported by Director Rice to accept a Leave of Absence for Jennifer Rolle from her Para-Professional position, effective January 24, 2022, through June 3, 2022. Motion carried unanimously.

APPROVE AN ASSISTANT CHEER COACH

Moved by Director Rice, supported by Director Lappi to approve the addition of an assistant cheer coach, effective December 13, 2021. Motion carried unanimously.

ACCEPT THE RESIGNATION OF LISA SORENSEN

Moved by Director Corradi-Simon, supported by Director Lappi to accept the resignation of Lisa Sorensen, Para-professional, Elementary School, effective December 6, 2021. Motion carried unanimously.

TRANSFER OF DARLYN HANSEN

Moved by Director Sever, supported by Director Lappi the transfer of Darlyn Hansen from Job #179, Temporary High School Custodian, Step III, to Para-professional Vaughan - Steffensrud, effective December 6, 2021. Motion carried unanimously.

TRANSFER OF CRYSTAL FLACK

Moved by Director Sever, supported by Director Corradi-Simon to approve transfer of Crystal Flack, Para-Professional, Elementary, to Job #183, High School Para-Professional, effective December 6, 2021. Motion carried unanimously.

POST JOB #184, INTERNAL/EXTERNAL PARA-PROFESSIONAL, CHISHOLM ELEMENTARY

Moved by Director Corradi-Simon, supported by Director Lappi to approve the posting of Job #184, Internal/External Para-Professional, Chisholm Elementary, effective December 10, 2021. Motion carried unanimously.

**Business**

APPROVE WORLD'S BEST WORKFORCE

Moved by Director Lappi, supported by Board Chair Rahja to approve World's Best Workforce Report. Motion carried unanimously.

APPROVE PAYMENT TO RYAN'S INDEPENDENT ELECTRIC FOR HS GFCI WORK

Moved by Director Sever, supported by Director Corradi-Simon to approve payment to Ryan's Independent Electric, Inc. in the amount of \$15,900.00 for work completed at the High School to replace Ground Fault Circuit Interrupter equipment. Motion carried unanimously.

APPROVE PROPOSED ACTIVITY FEE

Moved by Director Corradi-Simon, supported by Director Sauter to approve the following:

1. Student completes the application for Educational Benefits or is on the Direct Certification List and qualifies for Free Lunch; the district will pay the activity fee.
2. Student completes the application for Educational Benefits and qualifies for reduced lunch; ½ of the activity fee will be paid by the district.

Motion carried unanimously.

APPROVE APPTEGY CONTRACT

Moved by Director Sauter, supported by Director Lappi to approve apptegy contract in the amount of \$13,280.00. Motion carried unanimously.

ADOPT RESOLUTION

Moved by Director Corradi-Simon, supported by Director Rice to adopt resolution to accept donations. Motion carried unanimously.

**Discussion:** None

**Information:**

-Curriculum Updates

-Enrollment Numbers

ADJOURN

Moved by Director Corradi-Simon, supported by Director Lappi to adjourn the meeting at 5:44 P.M. Motion carried unanimously.

---

Clarice Sever, clerk

CS/lea

December 13, 2021

The Regular Meeting of the School Board, Independent School District No. 695, was called to order at 6:08 P.M. on December 13, 2021. Members present: Directors Sever, Rice, Corradi-Simon, Sauter, Lappi, Chair Rahja and Superintendent Norman.  
Members Absent: None

MOTION TO APPROVE THE AGENDA

Moved by Director Corradi-Simon, supported by Director Lappi to approve the Truth in Taxation agenda. Motion carried unanimously.

PRESENTATION OF 2022 TAX LEVY AND FISCAL 2021 BUDGET

Mr. Alex Kaczor presented the 2022 tax levy and fiscal 2021 budget. The opportunity for the public to comment/question after the levy was given.

ADOPT AND CERTIFY THE FINAL 2021 PAYABLE 2022 LEVY IN THE AMOUNT OF \$1,085,130.25.

Moved by Director Rice, supported by Director Corradi-Simon to adopt and certify the final 2021 Payable 2022 Levy in the amount of \$1,085,130.25. Motion carried unanimously.

ADJOURN

Moved by Director Corradi-Simon, supported by Director Lappi to adjourn the Truth in Taxation meeting at 6:33 PM. Motion carried unanimously.

---

Clarice Sever, clerk

CS/lea

December 23, 2021

The Special Meeting of the School Board, Independent School District No. 695, was called to order at 12:03 P.M. on December 23, 2021, in the Elementary Board Room. Members present: Directors Sever, Rice, Sauter, Chair Rahja and Superintendent Norman  
Members Absent: Director Corradi-Simon, Lappi

APPROVE AGENDA

Moved by Director Sever, supported by Director Rice to approve the agenda. Motion carried unanimously.

PRESENTATION STERLE & CO.

Sterle & Co. presented the fiscal year 2021 audit.

**Administrative Business:**

APPROVE THE FISCAL YEAR 2021 AUDIT FINANCIAL REPORT

Moved by Director Rice, supported by Director Sauter to approve the fiscal year 2021 audit financial report. Motion carried unanimously.

ADJOURN

Moved by Director Sever, supported by Director Rice to adjourn the meeting at 12:28 PM. Motion carried unanimously.

---

Clarice Sever, clerk

CS/lea

Adrian Norman III  
Superintendent  
Ext. 2900

Jennifer Crotteau  
Counselor  
Ext. 3904

Community Education  
Ext. 3132



Mark C. Morrison  
Sr. High Principal  
Ext. 3900

Jeffrey S. Hancock  
Pre K-6 Principal  
Ext. 1900: Pre K-3

Jamie Steinberg  
Activities Director  
Ext. 3902

January 6, 2022

To: Adrian Norman  
Superintendent

The following is a summary of payrolls for the month of December 2021.

December Payrolls

December	15 payroll	\$ 278,006.16
December	30 payroll	\$ 319,930.94

Total Payrolls	\$ 597,937.10
----------------	---------------

Alex Kaczor  
Business Manager  
AK:kk

Summary of Payments Issued:

December Accounts Payable Checks	\$436,447.07
December Accounts Payable Wires	<u>\$162.25</u>
Total Accounts Payable	\$436,609.32

### ISD 695-Chisholm Void Payment Listing with Detail

Batch	Co	Pmt No	Bank	Check No	Pmt Dt	Type	Grp Code	Rcd	Vendor	Curr	Print	Recon	Void	Vou No	Period	Void Dt	Amount
0695		34644	10	65890	11/24/2021	Check	1 3773		APOLLO MUSIC AND ENTE	USD	Yes	No	Yes	58729	202206	12/13/2021	(250.00)
Payment Total:																	
<input type="text" value="(250.00)"/>																	

**ISD 695-Chisholm**  
**Payment Reg by Bank and Check**

Bank	Batch	Pmt No	Check No	Pay Type	Grp Code	Rcd	Vendor	Tax Class	Pay/Void			Amount		
									Print	Recon	Void		Date	
10		34794		Wire	1 3046		FURTHER		No	No	No	12/28/2021	162.25	
												Bank Total:		\$162.25
												Report Total:		\$162.25

## ISD 695-Chisholm Check Register by Bank and Check

Batch	Co	Bank	Pymt No	Check No	Pay Type	Grp	Code	Rcd	Vendor	Print	Recon	Void	Currency	Pmt/Void Date	Amount
0695	10		34709	65931	Check	1	2423		AMAZON CAPITAL SERVICES	Yes	No	No	USD	12/07/2021	2,496.22
			34701	65932	Check	1	1944		AVIBEN	Yes	No	No	USD	12/07/2021	117.03
			34685	65933	Check	1	01612		C & J INTERIORS	Yes	No	No	USD	12/07/2021	250.10
			34698	65934	Check	1	1797		DELL MARKETING LP	Yes	No	No	USD	12/07/2021	860.00
			34704	65935	Check	1	2191		DULUTH RANGE COMMUNICATIONS	Yes	No	No	USD	12/07/2021	212.50
			34723	65936	Check	1	3739		GOOGLE VOICE INC	Yes	No	No	USD	12/07/2021	54.03
			34687	65937	Check	1	03570		GRAINGER	Yes	No	No	USD	12/07/2021	928.38
			34724	65938	Check	1	3764		GRAND RAPIDS HIGH SCHOOL	Yes	No	No	USD	12/07/2021	125.00
			34688	65939	Check	1	03577		GRAYBAR	Yes	No	No	USD	12/07/2021	635.10
			34708	65940	Check	1	2399		HIBBING CROSS COUNTRY	Yes	No	No	USD	12/07/2021	160.00
			34697	65941	Check	1	1375		HOGLUND BUS CO INC	Yes	No	No	USD	12/07/2021	87.58
			34689	65942	Check	1	04213		INAC, INC	Yes	No	No	USD	12/07/2021	67.30
			34719	65943	Check	1	3457		INGENSA INC.	Yes	No	No	USD	12/07/2021	23,115.50
			34699	65944	Check	1	1842		ISD #6076 NORTHLAND LEARNING	Yes	No	No	USD	12/07/2021	7,587.50
			34703	65945	Check	1	2183		JOLA & SOPP EXCAVATING INC	Yes	No	No	USD	12/07/2021	5,650.00
			34686	65946	Check	1	03553		JUBILEE FOODS	Yes	No	No	USD	12/07/2021	39.27
			34722	65947	Check	1	3715		KRISTEN HOHEISEL	Yes	No	No	USD	12/07/2021	427.50
			34691	65948	Check	1	05206	R1	L & M SUPPLY FLEET SUPPLY	Yes	No	No	USD	12/07/2021	89.42
			34690	65949	Check	1	05201		LAKESHORE	Yes	No	No	USD	12/07/2021	66.48
			34692	65950	Check	1	05971		MARY'S LAKE STREET FLORAL	Yes	No	No	USD	12/07/2021	83.00
			34714	65951	Check	1	3097	REMIT	MINNEAPOLIS OXYGEN COMPANY	Yes	No	No	USD	12/07/2021	369.49
			34693	65952	Check	1	06294		MN ASSOCIATION OF SEC SCHOOL F	Yes	No	No	USD	12/07/2021	160.00
			34702	65953	Check	1	2060		MN DEPT OF HEALTH	Yes	No	No	USD	12/07/2021	1,920.00
			34694	65954	Check	1	06336		MN INDUSTRIES	Yes	No	No	USD	12/07/2021	948.55
			34706	65955	Check	1	2278		MN TELECOMMUNICATIONS	Yes	No	No	USD	12/07/2021	1,199.39
			34710	65956	Check	1	2511		MUSIC IS ELEMENTARY	Yes	No	No	USD	12/07/2021	36.90
			34707	65957	Check	1	2303		NAPA AUTO PARTS	Yes	No	No	USD	12/07/2021	117.63
			34716	65958	Check	1	3119	REMIT	PNC BANK C/O FIRST BOOK	Yes	No	No	USD	12/07/2021	207.90
			34695	65959	Check	1	08317		RANGE MENTAL HEALTH CENTER IN	Yes	No	No	USD	12/07/2021	342.75
			34705	65960	Check	1	2272		RYANS INDEPENDENT ELECTRIC	Yes	No	No	USD	12/07/2021	15,900.00
			34713	65961	Check	1	3062		RYKS, KEVIN	Yes	No	No	USD	12/07/2021	193.00
			34718	65962	Check	1	3202		SANTELLI, CORY	Yes	No	No	USD	12/07/2021	145.00
			34725	65963	Check	1	3786		SHELLY MAKI	Yes	No	No	USD	12/07/2021	90.00
			34720	65964	Check	1	3628		SWANK MOTION PICTURES INC	Yes	No	No	USD	12/07/2021	750.00
			34717	65965	Check	1	3164		TAUS, DAVID	Yes	No	No	USD	12/07/2021	67.50
			34712	65966	Check	1	2963		TEACHERS ON CALL	Yes	No	No	USD	12/07/2021	2,336.52
			34711	65967	Check	1	2657	REMIT	TIERNEY BROTHERS INC	Yes	No	No	USD	12/07/2021	43,416.00
			34721	65968	Check	1	3713		TREVENA BRENT	Yes	No	No	USD	12/07/2021	145.00
			34700	65969	Check	1	1931		TRIMARK INDUSTRIAL	Yes	No	No	USD	12/07/2021	338.86
			34696	65970	Check	1	1340		ULINE	Yes	No	No	USD	12/07/2021	558.95
			34715	65971	Check	1	3116		WAGNER, JON	Yes	No	No	USD	12/07/2021	145.00

## ISD 695-Chisholm Check Register by Bank and Check

Batch	Co	Bank	Pymt No	Check No	Pay Type	Grp	Code	Rcd	Vendor	Print	Recon	Void	Currency	Pmt/Void Date	Amount
0695		10	34728	65972	Check	1	2354		ATT MOBILITY	Yes	No	No	USD	12/09/2021	94.38
			34729	65973	Check	1	2668		CONSOLIDATED COMMUNICATIONS	Yes	No	No	USD	12/09/2021	1,057.52
			34730	65974	Check	1	3721		ISD# 2909 ROCK RIDGE PUBLIC SCH	Yes	No	No	USD	12/09/2021	150.00
			34726	65975	Check	1	06326		MCEA EXECUTIVE OFFICE	Yes	No	No	USD	12/09/2021	152.00
			34727	65976	Check	1	2101		MN ENERGY RESOURCES CORP	Yes	No	No	USD	12/09/2021	25,587.40
			34731	65977	Check	1	3787		TRES INC	Yes	No	No	USD	12/09/2021	35,221.20
			34734	65978	Check	1	3387		BLUE CROSS BLUE SHIELD OF MN B	Yes	No	No	USD	12/14/2021	270.40
			34735	65979	Check	1	3387		BLUE CROSS BLUE SHIELD OF MN B	Yes	No	No	USD	12/14/2021	2,794.00
			34733	65980	Check	1	2971		MINNESOTA LIFE INSURANCE	Yes	No	No	USD	12/14/2021	2,024.24
			34732	65981	Check	1	06979		NORTHERN MINNESOTA DENTAL, INC	Yes	No	No	USD	12/14/2021	8,614.00
			34756	65982	Check	1	2423		AMAZON CAPITAL SERVICES	Yes	No	No	USD	12/15/2021	452.31
			34780	65983	Check	1	3790		ANDREW FORBORT	Yes	No	No	USD	12/15/2021	191.00
			34772	65984	Check	1	3220		APG MEDIA OF MN	Yes	No	No	USD	12/15/2021	124.80
			34761	65985	Check	1	2919		ARROWHEAD DRIVERS TRAINING LT	Yes	No	No	USD	12/15/2021	270.00
			34755	65986	Check	1	2354		ATT MOBILITY	Yes	No	No	USD	12/15/2021	453.94
			34736	65987	Check	1	00610		BARK DESIGN INC	Yes	No	No	USD	12/15/2021	453.83
			34776	65988	Check	1	3702		BAUDHUIN, CHRIS	Yes	No	No	USD	12/15/2021	193.00
			34779	65989	Check	1	3789		BILL BRINK	Yes	No	No	USD	12/15/2021	209.00
			34759	65990	Check	1	2774		BUHL WATER CO INC	Yes	No	No	USD	12/15/2021	80.00
			34760	65991	Check	1	2870		CASEY'S	Yes	No	No	USD	12/15/2021	65.96
			34773	65992	Check	1	3384		CHEERLEADING.COM	Yes	No	No	USD	12/15/2021	98.32
			34737	65993	Check	1	01600		CHISHOLM CITY OF	Yes	No	No	USD	12/15/2021	4,805.57
			34777	65994	Check	1	3754		DONALD W LALONDE	Yes	No	No	USD	12/15/2021	90.00
			34752	65995	Check	1	2191		DULUTH RANGE COMMUNICATIONS	Yes	No	No	USD	12/15/2021	170.00
			34762	65996	Check	1	2944		EDUCATION INNOVATION PARTNERS	Yes	No	No	USD	12/15/2021	209.68
			34738	65997	Check	1	03018		EXCEL BUSINESS SYSTEM	Yes	No	No	USD	12/15/2021	8,425.40
			34770	65998	Check	1	3191		FLOERSHEIM, WILLIAM	Yes	No	No	USD	12/15/2021	183.00
			34757	65999	Check	1	2548		FOLLET SCHOOL SOLUTIONS INC	Yes	No	No	USD	12/15/2021	2,270.19
			34740	66000	Check	1	04213		INAC, INC	Yes	No	No	USD	12/15/2021	15.90
			34741	66001	Check	1	04300		ISD #0701 HIBBING	Yes	No	No	USD	12/15/2021	6,667.00
			34781	66002	Check	1	3791		JACE JANEZICH	Yes	No	No	USD	12/15/2021	250.00
			34775	66003	Check	1	3459		JOHNSON, PHILLIP	Yes	No	No	USD	12/15/2021	145.00
			34739	66004	Check	1	03553		JUBILEE FOODS	Yes	No	No	USD	12/15/2021	255.79
			34778	66005	Check	1	3788		KEY CLUB INTERNATIONAL	Yes	No	No	USD	12/15/2021	75.00
			34764	66006	Check	1	2970		KOWARSCH, LYNETTE	Yes	No	No	USD	12/15/2021	134.93
			34747	66007	Check	1	1416		LIFE SECURITY AND CONTROL	Yes	No	No	USD	12/15/2021	138.00
			34753	66008	Check	1	2232		LOWE'S	Yes	No	No	USD	12/15/2021	191.44
			34748	66009	Check	1	1584		MID-AMERICAN RESEARCH CHEMICALS	Yes	No	No	USD	12/15/2021	1,137.83
			34767	66010	Check	1	3097	REMIT	MINNEAPOLIS OXYGEN COMPANY	Yes	No	No	USD	12/15/2021	314.01
			34742	66011	Check	1	06336		MN INDUSTRIES	Yes	No	No	USD	12/15/2021	5,099.27
			34743	66012	Check	1	06635		MUSIC IN MOTION	Yes	No	No	USD	12/15/2021	653.40

**ISD 695-Chisholm**  
**Check Register by Bank and Check**

Batch	Co	Bank	Pymt No	Check No	Pay Type	Grp	Code	Rcd	Vendor	Print	Recon	Void	Currency	Pmt/Void Date	Amount
0695		10	34744	66013	Check	1	06850		NORTHEAST SERVICE COOPERATIV	Yes	No	No	USD	12/15/2021	720.00
			34758	66014	Check	1	2736		NORTHERN BUSINESS PRODUCTS II	Yes	No	No	USD	12/15/2021	795.45
			34769	66015	Check	1	3190		PERSONS, DANIELL	Yes	No	No	USD	12/15/2021	145.00
			34750	66016	Check	1	2019	REMIT	PURCHASE POWER	Yes	No	No	USD	12/15/2021	10.94
			34751	66017	Check	1	2051		RANGER YEARBOOK	Yes	No	No	USD	12/15/2021	67.00
			34754	66018	Check	1	2272		RYANS INDEPENDENT ELECTRIC	Yes	No	No	USD	12/15/2021	1,265.00
			34766	66019	Check	1	3062		RYKS, KEVIN	Yes	No	No	USD	12/15/2021	145.00
			34771	66020	Check	1	3202		SANTELLI, CORY	Yes	No	No	USD	12/15/2021	145.00
			34774	66021	Check	1	3418		SCAIA, KEVIN R	Yes	No	No	USD	12/15/2021	145.00
			34749	66022	Check	1	1808		ST LOUIS CTY AUDITOR	Yes	No	No	USD	12/15/2021	535.11
			34745	66023	Check	1	09645		SULLIVAN SUPPLY	Yes	No	No	USD	12/15/2021	367.06
			34763	66024	Check	1	2963		TEACHERS ON CALL	Yes	No	No	USD	12/15/2021	4,665.82
			34765	66025	Check	1	3001		THOMPSON, DAWN	Yes	No	No	USD	12/15/2021	135.00
			34746	66026	Check	1	10137		UNITED TRUCK BODY CO INC	Yes	No	No	USD	12/15/2021	26.54
			34768	66027	Check	1	3116		WAGNER, JON	Yes	No	No	USD	12/15/2021	145.00
			34782	66028	Check	1	2614		CW TECHNOLOGY	Yes	No	No	USD	12/15/2021	863.00
			34783	66029	Check	1	3679		ZOOM VIDEO COMMUNICATIONS INC	Yes	No	No	USD	12/15/2021	3,043.15
			34785	66030	Check	1	3765		ALEX KACZOR	Yes	No	No	USD	12/16/2021	893.35
			34784	66031	Check	1	2963		TEACHERS ON CALL	Yes	No	No	USD	12/16/2021	3,957.40
			34786	66032	Check	1	3792		NATHAN LUTZKA	Yes	No	No	USD	12/16/2021	913.35
			34787	66033	Check	1	3387		BLUE CROSS BLUE SHIELD OF MN B	Yes	No	No	USD	12/16/2021	11,570.00
			34788	66034	Check	1	3376		CROTTEAU, JENNIFER	Yes	No	No	USD	12/16/2021	158.55
			34789	66035	Check	1	3793		BETHEL UNIVERSITY	Yes	No	No	USD	12/21/2021	4,815.00
			34790	66036	Check	1	00150	R1	ARAMARK	Yes	No	No	USD	12/23/2021	1,134.76
			34792	66037	Check	1	2705		HORIZON COMMERCIAL POOL SUPP	Yes	No	No	USD	12/23/2021	1,476.85
			34791	66038	Check	1	2101		MN ENERGY RESOURCES CORP	Yes	No	No	USD	12/23/2021	59.15
			34793	66039	Check	1	2320		MEDICARE BLUE RX	Yes	No	No	USD	12/28/2021	17,588.60
			34807	66040	Check	1	1041	REMIT	ALLDATA	Yes	No	No	USD	12/29/2021	975.00
			34813	66041	Check	1	2423		AMAZON CAPITAL SERVICES	Yes	No	No	USD	12/29/2021	124.36
			34826	66042	Check	1	3794		BHS	Yes	No	No	USD	12/29/2021	75.00
			34814	66043	Check	1	2502		BLACK BEAR BAKERY	Yes	No	No	USD	12/29/2021	193.70
			34815	66044	Check	1	2614		CW TECHNOLOGY	Yes	No	No	USD	12/29/2021	863.00
			34810	66045	Check	1	1797		DELL MARKETING LP	Yes	No	No	USD	12/29/2021	354.00
			34806	66046	Check	1	10255		DEX MEDIA	Yes	No	No	USD	12/29/2021	134.00
			34795	66047	Check	1	02569		ECOLAB PEST ELIMINATION DIV	Yes	No	No	USD	12/29/2021	534.71
			34818	66048	Check	1	3081		FAIRVIEW HEALTH SERVICES	Yes	No	No	USD	12/29/2021	140.00
			34797	66049	Check	1	03570		GRAINGER	Yes	No	No	USD	12/29/2021	489.19
			34798	66050	Check	1	03577		GRAYBAR <sub>17</sub>	Yes	No	No	USD	12/29/2021	66.96
			34821	66051	Check	1	3255	R1	HUDL	Yes	No	No	USD	12/29/2021	2,250.00
			34799	66052	Check	1	04212		INAC, INC	Yes	No	No	USD	12/29/2021	59,365.75
			34825	66053	Check	1	3785	R1	INNOVATIVE OFFICE SOLUTIONS LLC	Yes	No	No	USD	12/29/2021	399.00

### ISD 695-Chisholm Check Register by Bank and Check

Batch	Co	Bank	Pymt No	Check No	Pay Type	Grp	Code	Rcd	Vendor	Print	Recon	Void	Currency	Pmt/Void Date	Amount
0695		10	34823	66054	Check	1	3689		IRON RANGE PLUMBING AND HEATIN	Yes	No	No	USD	12/29/2021	195.00
			34824	66055	Check	1	3714		IRON RANGE TOWING	Yes	No	No	USD	12/29/2021	150.00
			34800	66056	Check	1	04226		ISD #0318 GRAND RAPIDS	Yes	No	No	USD	12/29/2021	105.00
			34811	66057	Check	1	1842		ISD #6076 NORTHLAND LEARNING	Yes	No	No	USD	12/29/2021	77,241.73
			34796	66058	Check	1	03553		JUBILEE FOODS	Yes	No	No	USD	12/29/2021	18.27
			34801	66059	Check	1	05206	R1	L & M SUPPLY FLEET SUPPLY	Yes	No	No	USD	12/29/2021	35.94
			34809	66060	Check	1	1416		LIFE SECURITY AND CONTROL	Yes	No	No	USD	12/29/2021	300.00
			34819	66061	Check	1	3097	REMIT	MINNEAPOLIS OXYGEN COMPANY	Yes	No	No	USD	12/29/2021	42.25
			34827	66062	Check	1	3795		MINNESOTA TRUE TEAM TRACK	Yes	No	No	USD	12/29/2021	130.00
			34802	66063	Check	1	06336		MN INDUSTRIES	Yes	No	No	USD	12/29/2021	522.40
			34803	66064	Check	1	06850		NORTHEAST SERVICE COOPERATIV	Yes	No	No	USD	12/29/2021	4,048.24
			34804	66065	Check	1	07230		OSI ENVIRONMENTAL	Yes	No	No	USD	12/29/2021	100.00
			34805	66066	Check	1	08317		RANGE MENTAL HEALTH CENTER IN	Yes	No	No	USD	12/29/2021	1,077.75
			34822	66067	Check	1	3363		RANGE SPORTS	Yes	No	No	USD	12/29/2021	39.00
			34820	66068	Check	1	3175		SCHELDE, JULIE	Yes	No	No	USD	12/29/2021	444.00
			34812	66069	Check	1	2121	2	SCHMITT MUSIC - REMIT	Yes	No	No	USD	12/29/2021	275.00
			34816	66070	Check	1	2859	REMIT	SHRED IT USA	Yes	No	No	USD	12/29/2021	477.63
			34808	66071	Check	1	1088		SPECIAL SCHOOL DISTRICT NO. 1	Yes	No	No	USD	12/29/2021	110.32
			34817	66072	Check	1	2963		TEACHERS ON CALL	Yes	No	No	USD	12/29/2021	4,747.76
			34828	66073	Check	1	05731		MADISON NATIONAL LIFE INS CO	Yes	No	No	USD	12/30/2021	2,406.97
Bank Total: 10														\$436,447.07	
Report Total:														\$436,447.07	

## ISD 695-Chisholm Check Register by Bank and Check

Batch	Co	Bank	Pymt No	Check No	Pay Type	Grp	Code	Rcd	Vendor	Print	Recon	Void	Currency	Pmt/Void Date	Amount
0695	10		34785	66030	Check	1	3765		ALEX KACZOR	Yes	No	No	USD	12/16/2021	893.35
			34807	66040	Check	1	1041	REMIT	ALLDATA	Yes	No	No	USD	12/29/2021	975.00
			34709	65931	Check	1	2423		AMAZON CAPITAL SERVICES	Yes	No	No	USD	12/07/2021	2,496.22
			34756	65982	Check	1	2423		AMAZON CAPITAL SERVICES	Yes	No	No	USD	12/15/2021	452.31
			34813	66041	Check	1	2423		AMAZON CAPITAL SERVICES	Yes	No	No	USD	12/29/2021	124.36
			34780	65983	Check	1	3790		ANDREW FORBORT	Yes	No	No	USD	12/15/2021	191.00
			34772	65984	Check	1	3220		APG MEDIA OF MN	Yes	No	No	USD	12/15/2021	124.80
			34790	66036	Check	1	00150	R1	ARAMARK	Yes	No	No	USD	12/23/2021	1,134.76
			34761	65985	Check	1	2919		ARROWHEAD DRIVERS TRAINING LT	Yes	No	No	USD	12/15/2021	270.00
			34728	65972	Check	1	2354		ATT MOBILITY	Yes	No	No	USD	12/09/2021	94.38
			34755	65986	Check	1	2354		ATT MOBILITY	Yes	No	No	USD	12/15/2021	453.94
			34701	65932	Check	1	1944		AVIBEN	Yes	No	No	USD	12/07/2021	117.03
			34736	65987	Check	1	00610		BARK DESIGN INC	Yes	No	No	USD	12/15/2021	453.83
			34776	65988	Check	1	3702		BAUDHUIN, CHRIS	Yes	No	No	USD	12/15/2021	193.00
			34789	66035	Check	1	3793		BETHEL UNIVERSITY	Yes	No	No	USD	12/21/2021	4,815.00
			34826	66042	Check	1	3794		BHS	Yes	No	No	USD	12/29/2021	75.00
			34779	65989	Check	1	3789		BILL BRINK	Yes	No	No	USD	12/15/2021	209.00
			34814	66043	Check	1	2502		BLACK BEAR BAKERY	Yes	No	No	USD	12/29/2021	193.70
			34734	65978	Check	1	3387		BLUE CROSS BLUE SHIELD OF MN B	Yes	No	No	USD	12/14/2021	270.40
			34735	65979	Check	1	3387		BLUE CROSS BLUE SHIELD OF MN B	Yes	No	No	USD	12/14/2021	2,794.00
			34787	66033	Check	1	3387		BLUE CROSS BLUE SHIELD OF MN B	Yes	No	No	USD	12/16/2021	11,570.00
			34759	65990	Check	1	2774		BUHL WATER CO INC	Yes	No	No	USD	12/15/2021	80.00
			34685	65933	Check	1	01612		C & J INTERIORS	Yes	No	No	USD	12/07/2021	250.10
			34760	65991	Check	1	2870		CASEY'S	Yes	No	No	USD	12/15/2021	65.96
			34773	65992	Check	1	3384		CHEERLEADING.COM	Yes	No	No	USD	12/15/2021	98.32
			34737	65993	Check	1	01600		CHISHOLM CITY OF	Yes	No	No	USD	12/15/2021	4,805.57
			34729	65973	Check	1	2668		CONSOLIDATED COMMUNICATIONS	Yes	No	No	USD	12/09/2021	1,057.52
			34788	66034	Check	1	3376		CROTTEAU, JENNIFER	Yes	No	No	USD	12/16/2021	158.55
			34782	66028	Check	1	2614		CW TECHNOLOGY	Yes	No	No	USD	12/15/2021	863.00
			34815	66044	Check	1	2614		CW TECHNOLOGY	Yes	No	No	USD	12/29/2021	863.00
			34698	65934	Check	1	1797		DELL MARKETING LP	Yes	No	No	USD	12/07/2021	860.00
			34810	66045	Check	1	1797		DELL MARKETING LP	Yes	No	No	USD	12/29/2021	354.00
			34806	66046	Check	1	10255		DEX MEDIA	Yes	No	No	USD	12/29/2021	134.00
			34777	65994	Check	1	3754		DONALD W LALONDE	Yes	No	No	USD	12/15/2021	90.00
			34704	65935	Check	1	2191		DULUTH RANGE COMMUNICATIONS	Yes	No	No	USD	12/07/2021	212.50
			34752	65995	Check	1	2191		DULUTH RANGE COMMUNICATIONS	Yes	No	No	USD	12/15/2021	170.00
			34795	66047	Check	1	02569		ECOLAB PEST ELIMINATION DIV	Yes	No	No	USD	12/29/2021	534.71
			34762	65996	Check	1	2944		EDUCATION INNOVATION PARTNERS	Yes	No	No	USD	12/15/2021	209.68
			34738	65997	Check	1	03018		EXCEL BUSINESS SYSTEM	Yes	No	No	USD	12/15/2021	8,425.40
			34818	66048	Check	1	3081		FAIRVIEW HEALTH SERVICES	Yes	No	No	USD	12/29/2021	140.00
			34770	65998	Check	1	3191		FLOERSHEIM, WILLIAM	Yes	No	No	USD	12/15/2021	183.00

## ISD 695-Chisholm Check Register by Bank and Check

Batch	Co	Bank	Pymt No	Check No	Pay Type	Grp	Code	Rcd	Vendor	Print	Recon	Void	Currency	Pmt/Void Date	Amount
0695		10	34757	65999	Check	1	2548		FOLLET SCHOOL SOLUTIONS INC	Yes	No	No	USD	12/15/2021	2,270.19
			34723	65936	Check	1	3739		GOOGLE VOICE INC	Yes	No	No	USD	12/07/2021	54.03
			34687	65937	Check	1	03570		GRAINGER	Yes	No	No	USD	12/07/2021	928.38
			34797	66049	Check	1	03570		GRAINGER	Yes	No	No	USD	12/29/2021	489.19
			34724	65938	Check	1	3764		GRAND RAPIDS HIGH SCHOOL	Yes	No	No	USD	12/07/2021	125.00
			34688	65939	Check	1	03577		GRAYBAR	Yes	No	No	USD	12/07/2021	635.10
			34798	66050	Check	1	03577		GRAYBAR	Yes	No	No	USD	12/29/2021	66.96
			34708	65940	Check	1	2399		HIBBING CROSS COUNTRY	Yes	No	No	USD	12/07/2021	160.00
			34697	65941	Check	1	1375		HOGLUND BUS CO INC	Yes	No	No	USD	12/07/2021	87.58
			34792	66037	Check	1	2705		HORIZON COMMERCIAL POOL SUPP	Yes	No	No	USD	12/23/2021	1,476.85
			34821	66051	Check	1	3255	R1	HUDL	Yes	No	No	USD	12/29/2021	2,250.00
			34689	65942	Check	1	04213		INAC, INC	Yes	No	No	USD	12/07/2021	67.30
			34740	66000	Check	1	04213		INAC, INC	Yes	No	No	USD	12/15/2021	15.90
			34799	66052	Check	1	04212		INAC, INC	Yes	No	No	USD	12/29/2021	59,365.75
			34719	65943	Check	1	3457		INGENSA INC.	Yes	No	No	USD	12/07/2021	23,115.50
			34825	66053	Check	1	3785	R1	INNOVATIVE OFFICE SOLUTIONS LLC	Yes	No	No	USD	12/29/2021	399.00
			34823	66054	Check	1	3689		IRON RANGE PLUMBING AND HEATIN	Yes	No	No	USD	12/29/2021	195.00
			34824	66055	Check	1	3714		IRON RANGE TOWING	Yes	No	No	USD	12/29/2021	150.00
			34800	66056	Check	1	04226		ISD #0318 GRAND RAPIDS	Yes	No	No	USD	12/29/2021	105.00
			34741	66001	Check	1	04300		ISD #0701 HIBBING	Yes	No	No	USD	12/15/2021	6,667.00
			34699	65944	Check	1	1842		ISD #6076 NORTHLAND LEARNING	Yes	No	No	USD	12/07/2021	7,587.50
			34811	66057	Check	1	1842		ISD #6076 NORTHLAND LEARNING	Yes	No	No	USD	12/29/2021	77,241.73
			34730	65974	Check	1	3721		ISD# 2909 ROCK RIDGE PUBLIC SCH	Yes	No	No	USD	12/09/2021	150.00
			34781	66002	Check	1	3791		JACE JANEZICH	Yes	No	No	USD	12/15/2021	250.00
			34775	66003	Check	1	3459		JOHNSON, PHILLIP	Yes	No	No	USD	12/15/2021	145.00
			34703	65945	Check	1	2183		JOLA & SOPP EXCAVATING INC	Yes	No	No	USD	12/07/2021	5,650.00
			34686	65946	Check	1	03553		JUBILEE FOODS	Yes	No	No	USD	12/07/2021	39.27
			34739	66004	Check	1	03553		JUBILEE FOODS	Yes	No	No	USD	12/15/2021	255.79
			34796	66058	Check	1	03553		JUBILEE FOODS	Yes	No	No	USD	12/29/2021	18.27
			34778	66005	Check	1	3788		KEY CLUB INTERNATIONAL	Yes	No	No	USD	12/15/2021	75.00
			34764	66006	Check	1	2970		KOWARSCH, LYNETTE	Yes	No	No	USD	12/15/2021	134.93
			34722	65947	Check	1	3715		KRISTEN HOHEISEL	Yes	No	No	USD	12/07/2021	427.50
			34691	65948	Check	1	05206	R1	L & M SUPPLY FLEET SUPPLY	Yes	No	No	USD	12/07/2021	89.42
			34801	66059	Check	1	05206	R1	L & M SUPPLY FLEET SUPPLY	Yes	No	No	USD	12/29/2021	35.94
			34690	65949	Check	1	05201		LAKESHORE	Yes	No	No	USD	12/07/2021	66.48
			34747	66007	Check	1	1416		LIFE SECURITY AND CONTROL	Yes	No	No	USD	12/15/2021	138.00
			34809	66060	Check	1	1416		LIFE SECURITY AND CONTROL	Yes	No	No	USD	12/29/2021	300.00
			34753	66008	Check	1	2232		LOWE'S 20	Yes	No	No	USD	12/15/2021	191.44
			34828	66073	Check	1	05731		MADISON NATIONAL LIFE INS CO	Yes	No	No	USD	12/30/2021	2,406.97
			34692	65950	Check	1	05971		MARY'S LAKE STREET FLORAL	Yes	No	No	USD	12/07/2021	83.00
			34726	65975	Check	1	06326		MCEA EXECUTIVE OFFICE	Yes	No	No	USD	12/09/2021	152.00

## ISD 695-Chisholm Check Register by Bank and Check

Batch	Co	Bank	Pymt No	Check No	Pay Type	Grp	Code	Rcd	Vendor	Print	Recon	Void	Currency	Pmt/Void Date	Amount
0695	10		34793	66039	Check	1	2320		MEDICARE BLUE RX	Yes	No	No	USD	12/28/2021	17,588.60
			34748	66009	Check	1	1584		MID-AMERICAN RESEARCH CHEMICALS	Yes	No	No	USD	12/15/2021	1,137.83
			34714	65951	Check	1	3097	REMIT	MINNEAPOLIS OXYGEN COMPANY	Yes	No	No	USD	12/07/2021	369.49
			34767	66010	Check	1	3097	REMIT	MINNEAPOLIS OXYGEN COMPANY	Yes	No	No	USD	12/15/2021	314.01
			34819	66061	Check	1	3097	REMIT	MINNEAPOLIS OXYGEN COMPANY	Yes	No	No	USD	12/29/2021	42.25
			34733	65980	Check	1	2971		MINNESOTA LIFE INSURANCE	Yes	No	No	USD	12/14/2021	2,024.24
			34827	66062	Check	1	3795		MINNESOTA TRUE TEAM TRACK	Yes	No	No	USD	12/29/2021	130.00
			34693	65952	Check	1	06294		MN ASSOCIATION OF SEC SCHOOL F	Yes	No	No	USD	12/07/2021	160.00
			34702	65953	Check	1	2060		MN DEPT OF HEALTH	Yes	No	No	USD	12/07/2021	1,920.00
			34727	65976	Check	1	2101		MN ENERGY RESOURCES CORP	Yes	No	No	USD	12/09/2021	25,587.40
			34791	66038	Check	1	2101		MN ENERGY RESOURCES CORP	Yes	No	No	USD	12/23/2021	59.15
			34694	65954	Check	1	06336		MN INDUSTRIES	Yes	No	No	USD	12/07/2021	948.55
			34742	66011	Check	1	06336		MN INDUSTRIES	Yes	No	No	USD	12/15/2021	5,099.27
			34802	66063	Check	1	06336		MN INDUSTRIES	Yes	No	No	USD	12/29/2021	522.40
			34706	65955	Check	1	2278		MN TELECOMMUNICATIONS	Yes	No	No	USD	12/07/2021	1,199.39
			34743	66012	Check	1	06635		MUSIC IN MOTION	Yes	No	No	USD	12/15/2021	653.40
			34710	65956	Check	1	2511		MUSIC IS ELEMENTARY	Yes	No	No	USD	12/07/2021	36.90
			34707	65957	Check	1	2303		NAPA AUTO PARTS	Yes	No	No	USD	12/07/2021	117.63
			34786	66032	Check	1	3792		NATHAN LUTZKA	Yes	No	No	USD	12/16/2021	913.35
			34744	66013	Check	1	06850		NORTHEAST SERVICE COOPERATIV	Yes	No	No	USD	12/15/2021	720.00
			34803	66064	Check	1	06850		NORTHEAST SERVICE COOPERATIV	Yes	No	No	USD	12/29/2021	4,048.24
			34758	66014	Check	1	2736		NORTHERN BUSINESS PRODUCTS II	Yes	No	No	USD	12/15/2021	795.45
			34732	65981	Check	1	06979		NORTHERN MINNESOTA DENTAL, INC	Yes	No	No	USD	12/14/2021	8,614.00
			34804	66065	Check	1	07230		OSI ENVIRONMENTAL	Yes	No	No	USD	12/29/2021	100.00
			34769	66015	Check	1	3190		PERSONS, DANIELL	Yes	No	No	USD	12/15/2021	145.00
			34716	65958	Check	1	3119	REMIT	PNC BANK C/O FIRST BOOK	Yes	No	No	USD	12/07/2021	207.90
			34750	66016	Check	1	2019	REMIT	PURCHASE POWER	Yes	No	No	USD	12/15/2021	10.94
			34695	65959	Check	1	08317		RANGE MENTAL HEALTH CENTER IN	Yes	No	No	USD	12/07/2021	342.75
			34805	66066	Check	1	08317		RANGE MENTAL HEALTH CENTER IN	Yes	No	No	USD	12/29/2021	1,077.75
			34822	66067	Check	1	3363		RANGE SPORTS	Yes	No	No	USD	12/29/2021	39.00
			34751	66017	Check	1	2051		RANGER YEARBOOK	Yes	No	No	USD	12/15/2021	67.00
			34705	65960	Check	1	2272		RYANS INDEPENDENT ELECTRIC	Yes	No	No	USD	12/07/2021	15,900.00
			34754	66018	Check	1	2272		RYANS INDEPENDENT ELECTRIC	Yes	No	No	USD	12/15/2021	1,265.00
			34713	65961	Check	1	3062		RYKS, KEVIN	Yes	No	No	USD	12/07/2021	193.00
			34766	66019	Check	1	3062		RYKS, KEVIN	Yes	No	No	USD	12/15/2021	145.00
			34718	65962	Check	1	3202		SANTELLI, CORY	Yes	No	No	USD	12/07/2021	145.00
			34771	66020	Check	1	3202		SANTELLI, CORY	Yes	No	No	USD	12/15/2021	145.00
			34774	66021	Check	1	3418		SCAIA, KEVIN R	Yes	No	No	USD	12/15/2021	145.00
			34820	66068	Check	1	3175		SCHELDE, JULIE	Yes	No	No	USD	12/29/2021	444.00
			34812	66069	Check	1	2121	2	SCHMITT MUSIC - REMIT	Yes	No	No	USD	12/29/2021	275.00
			34725	65963	Check	1	3786		SHELLY MAKI	Yes	No	No	USD	12/07/2021	90.00

## ISD 695-Chisholm Check Register by Bank and Check

Batch	Co	Bank	Pymt No	Check No	Pay Type	Grp	Code	Rcd	Vendor	Print	Recon	Void	Currency	Pmt/Void Date	Amount
0695		10	34816	66070	Check	1	2859	REMIT	SHRED IT USA	Yes	No	No	USD	12/29/2021	477.63
			34808	66071	Check	1	1088		SPECIAL SCHOOL DISTRICT NO. 1	Yes	No	No	USD	12/29/2021	110.32
			34749	66022	Check	1	1808		ST LOUIS CTY AUDITOR	Yes	No	No	USD	12/15/2021	535.11
			34745	66023	Check	1	09645		SULLIVAN SUPPLY	Yes	No	No	USD	12/15/2021	367.06
			34720	65964	Check	1	3628		SWANK MOTION PICTURES INC	Yes	No	No	USD	12/07/2021	750.00
			34717	65965	Check	1	3164		TAUS, DAVID	Yes	No	No	USD	12/07/2021	67.50
			34712	65966	Check	1	2963		TEACHERS ON CALL	Yes	No	No	USD	12/07/2021	2,336.52
			34763	66024	Check	1	2963		TEACHERS ON CALL	Yes	No	No	USD	12/15/2021	4,665.82
			34784	66031	Check	1	2963		TEACHERS ON CALL	Yes	No	No	USD	12/16/2021	3,957.40
			34817	66072	Check	1	2963		TEACHERS ON CALL	Yes	No	No	USD	12/29/2021	4,747.76
			34765	66025	Check	1	3001		THOMPSON, DAWN	Yes	No	No	USD	12/15/2021	135.00
			34711	65967	Check	1	2657	REMIT	TIERNEY BROTHERS INC	Yes	No	No	USD	12/07/2021	43,416.00
			34731	65977	Check	1	3787		TRES INC	Yes	No	No	USD	12/09/2021	35,221.20
			34721	65968	Check	1	3713		TREVENA, BRENT	Yes	No	No	USD	12/07/2021	145.00
			34700	65969	Check	1	1931		TRIMARK INDUSTRIAL	Yes	No	No	USD	12/07/2021	338.86
			34696	65970	Check	1	1340		ULINE	Yes	No	No	USD	12/07/2021	558.95
			34746	66026	Check	1	10137		UNITED TRUCK BODY CO INC	Yes	No	No	USD	12/15/2021	26.54
			34715	65971	Check	1	3116		WAGNER, JON	Yes	No	No	USD	12/07/2021	145.00
			34768	66027	Check	1	3116		WAGNER, JON	Yes	No	No	USD	12/15/2021	145.00
			34783	66029	Check	1	3679		ZOOM VIDEO COMMUNICATIONS INC	Yes	No	No	USD	12/15/2021	3,043.15
Bank Total: 10														\$436,447.07	
Report Total:														\$436,447.07	

Summary of Payments Issued:

December Accounts Payable Checks	\$436,447.07
December Accounts Payable Wires	<u>\$162.25</u>
Total Accounts Payable	\$436,609.32

### ISD 695-Chisholm Void Payment Listing with Detail

Batch	Co	Pmt No	Bank	Check No	Pmt Dt	Type	Grp Code	Rcd	Vendor	Curr	Print	Recon	Void	Vou No	Period	Void Dt	Amount
0695		34644	10	65890	11/24/2021	Check	1 3773		APOLLO MUSIC AND ENTE	USD	Yes	No	Yes	58729	202206	12/13/2021	(250.00)
Payment Total:																(250.00)	

### ISD 695-Chisholm Payment Reg by Bank and Check

Bank	Batch	Pmt No	Check No	Pay Type	Grp Code	Rcd	Vendor	Tax Class	Pay/Void			Amount		
									Print	Recon	Void		Date	
10		34794		Wire	1 3046		FURTHER		No	No	No	12/28/2021	162.25	
												Bank Total:		\$162.25
												Report Total:		\$162.25

## ISD 695-Chisholm Check Register by Bank and Check

Batch	Co	Bank	Pymt No	Check No	Pay Type	Grp	Code	Rcd	Vendor	Print	Recon	Void	Currency	Pmt/Void Date	Amount
0695	10		34709	65931	Check	1	2423		AMAZON CAPITAL SERVICES	Yes	No	No	USD	12/07/2021	2,496.22
			34701	65932	Check	1	1944		AVIBEN	Yes	No	No	USD	12/07/2021	117.03
			34685	65933	Check	1	01612		C & J INTERIORS	Yes	No	No	USD	12/07/2021	250.10
			34698	65934	Check	1	1797		DELL MARKETING LP	Yes	No	No	USD	12/07/2021	860.00
			34704	65935	Check	1	2191		DULUTH RANGE COMMUNICATIONS	Yes	No	No	USD	12/07/2021	212.50
			34723	65936	Check	1	3739		GOOGLE VOICE INC	Yes	No	No	USD	12/07/2021	54.03
			34687	65937	Check	1	03570		GRAINGER	Yes	No	No	USD	12/07/2021	928.38
			34724	65938	Check	1	3764		GRAND RAPIDS HIGH SCHOOL	Yes	No	No	USD	12/07/2021	125.00
			34688	65939	Check	1	03577		GRAYBAR	Yes	No	No	USD	12/07/2021	635.10
			34708	65940	Check	1	2399		HIBBING CROSS COUNTRY	Yes	No	No	USD	12/07/2021	160.00
			34697	65941	Check	1	1375		HOGLUND BUS CO INC	Yes	No	No	USD	12/07/2021	87.58
			34689	65942	Check	1	04213		INAC, INC	Yes	No	No	USD	12/07/2021	67.30
			34719	65943	Check	1	3457		INGENSA INC.	Yes	No	No	USD	12/07/2021	23,115.50
			34699	65944	Check	1	1842		ISD #6076 NORTHLAND LEARNING	Yes	No	No	USD	12/07/2021	7,587.50
			34703	65945	Check	1	2183		JOLA & SOPP EXCAVATING INC	Yes	No	No	USD	12/07/2021	5,650.00
			34686	65946	Check	1	03553		JUBILEE FOODS	Yes	No	No	USD	12/07/2021	39.27
			34722	65947	Check	1	3715		KRISTEN HOHEISEL	Yes	No	No	USD	12/07/2021	427.50
			34691	65948	Check	1	05206	R1	L & M SUPPLY FLEET SUPPLY	Yes	No	No	USD	12/07/2021	89.42
			34690	65949	Check	1	05201		LAKESHORE	Yes	No	No	USD	12/07/2021	66.48
			34692	65950	Check	1	05971		MARY'S LAKE STREET FLORAL	Yes	No	No	USD	12/07/2021	83.00
			34714	65951	Check	1	3097	REMIT	MINNEAPOLIS OXYGEN COMPANY	Yes	No	No	USD	12/07/2021	369.49
			34693	65952	Check	1	06294		MN ASSOCIATION OF SEC SCHOOL F	Yes	No	No	USD	12/07/2021	160.00
			34702	65953	Check	1	2060		MN DEPT OF HEALTH	Yes	No	No	USD	12/07/2021	1,920.00
			34694	65954	Check	1	06336		MN INDUSTRIES	Yes	No	No	USD	12/07/2021	948.55
			34706	65955	Check	1	2278		MN TELECOMMUNICATIONS	Yes	No	No	USD	12/07/2021	1,199.39
			34710	65956	Check	1	2511		MUSIC IS ELEMENTARY	Yes	No	No	USD	12/07/2021	36.90
			34707	65957	Check	1	2303		NAPA AUTO PARTS	Yes	No	No	USD	12/07/2021	117.63
			34716	65958	Check	1	3119	REMIT	PNC BANK C/O FIRST BOOK	Yes	No	No	USD	12/07/2021	207.90
			34695	65959	Check	1	08317		RANGE MENTAL HEALTH CENTER IN	Yes	No	No	USD	12/07/2021	342.75
			34705	65960	Check	1	2272		RYANS INDEPENDENT ELECTRIC	Yes	No	No	USD	12/07/2021	15,900.00
			34713	65961	Check	1	3062		RYKS, KEVIN	Yes	No	No	USD	12/07/2021	193.00
			34718	65962	Check	1	3202		SANTELLI, CORY	Yes	No	No	USD	12/07/2021	145.00
			34725	65963	Check	1	3786		SHELLY MAKI	Yes	No	No	USD	12/07/2021	90.00
			34720	65964	Check	1	3628		SWANK MOTION PICTURES INC	Yes	No	No	USD	12/07/2021	750.00
			34717	65965	Check	1	3164		TAUS, DAVID	Yes	No	No	USD	12/07/2021	67.50
			34712	65966	Check	1	2963		TEACHERS ON CALL	Yes	No	No	USD	12/07/2021	2,336.52
			34711	65967	Check	1	2657	REMIT	TIERNEY BROTHERS INC	Yes	No	No	USD	12/07/2021	43,416.00
			34721	65968	Check	1	3713		TREVENA BRENT	Yes	No	No	USD	12/07/2021	145.00
			34700	65969	Check	1	1931		TRIMARK INDUSTRIAL	Yes	No	No	USD	12/07/2021	338.86
			34696	65970	Check	1	1340		ULINE	Yes	No	No	USD	12/07/2021	558.95
			34715	65971	Check	1	3116		WAGNER, JON	Yes	No	No	USD	12/07/2021	145.00

## ISD 695-Chisholm Check Register by Bank and Check

Batch	Co	Bank	Pymt No	Check No	Pay Type	Grp	Code	Rcd	Vendor	Print	Recon	Void	Currency	Pmt/Void Date	Amount
0695		10	34728	65972	Check	1	2354		ATT MOBILITY	Yes	No	No	USD	12/09/2021	94.38
			34729	65973	Check	1	2668		CONSOLIDATED COMMUNICATIONS	Yes	No	No	USD	12/09/2021	1,057.52
			34730	65974	Check	1	3721		ISD# 2909 ROCK RIDGE PUBLIC SCH	Yes	No	No	USD	12/09/2021	150.00
			34726	65975	Check	1	06326		MCEA EXECUTIVE OFFICE	Yes	No	No	USD	12/09/2021	152.00
			34727	65976	Check	1	2101		MN ENERGY RESOURCES CORP	Yes	No	No	USD	12/09/2021	25,587.40
			34731	65977	Check	1	3787		TRES INC	Yes	No	No	USD	12/09/2021	35,221.20
			34734	65978	Check	1	3387		BLUE CROSS BLUE SHIELD OF MN B	Yes	No	No	USD	12/14/2021	270.40
			34735	65979	Check	1	3387		BLUE CROSS BLUE SHIELD OF MN B	Yes	No	No	USD	12/14/2021	2,794.00
			34733	65980	Check	1	2971		MINNESOTA LIFE INSURANCE	Yes	No	No	USD	12/14/2021	2,024.24
			34732	65981	Check	1	06979		NORTHERN MINNESOTA DENTAL, INC	Yes	No	No	USD	12/14/2021	8,614.00
			34756	65982	Check	1	2423		AMAZON CAPITAL SERVICES	Yes	No	No	USD	12/15/2021	452.31
			34780	65983	Check	1	3790		ANDREW FORBORT	Yes	No	No	USD	12/15/2021	191.00
			34772	65984	Check	1	3220		APG MEDIA OF MN	Yes	No	No	USD	12/15/2021	124.80
			34761	65985	Check	1	2919		ARROWHEAD DRIVERS TRAINING LT	Yes	No	No	USD	12/15/2021	270.00
			34755	65986	Check	1	2354		ATT MOBILITY	Yes	No	No	USD	12/15/2021	453.94
			34736	65987	Check	1	00610		BARK DESIGN INC	Yes	No	No	USD	12/15/2021	453.83
			34776	65988	Check	1	3702		BAUDHUIN, CHRIS	Yes	No	No	USD	12/15/2021	193.00
			34779	65989	Check	1	3789		BILL BRINK	Yes	No	No	USD	12/15/2021	209.00
			34759	65990	Check	1	2774		BUHL WATER CO INC	Yes	No	No	USD	12/15/2021	80.00
			34760	65991	Check	1	2870		CASEY'S	Yes	No	No	USD	12/15/2021	65.96
			34773	65992	Check	1	3384		CHEERLEADING.COM	Yes	No	No	USD	12/15/2021	98.32
			34737	65993	Check	1	01600		CHISHOLM CITY OF	Yes	No	No	USD	12/15/2021	4,805.57
			34777	65994	Check	1	3754		DONALD W LALONDE	Yes	No	No	USD	12/15/2021	90.00
			34752	65995	Check	1	2191		DULUTH RANGE COMMUNICATIONS	Yes	No	No	USD	12/15/2021	170.00
			34762	65996	Check	1	2944		EDUCATION INNOVATION PARTNERS	Yes	No	No	USD	12/15/2021	209.68
			34738	65997	Check	1	03018		EXCEL BUSINESS SYSTEM	Yes	No	No	USD	12/15/2021	8,425.40
			34770	65998	Check	1	3191		FLOERSHEIM, WILLIAM	Yes	No	No	USD	12/15/2021	183.00
			34757	65999	Check	1	2548		FOLLET SCHOOL SOLUTIONS INC	Yes	No	No	USD	12/15/2021	2,270.19
			34740	66000	Check	1	04213		INAC, INC	Yes	No	No	USD	12/15/2021	15.90
			34741	66001	Check	1	04300		ISD #0701 HIBBING	Yes	No	No	USD	12/15/2021	6,667.00
			34781	66002	Check	1	3791		JACE JANEZICH	Yes	No	No	USD	12/15/2021	250.00
			34775	66003	Check	1	3459		JOHNSON, PHILLIP	Yes	No	No	USD	12/15/2021	145.00
			34739	66004	Check	1	03553		JUBILEE FOODS	Yes	No	No	USD	12/15/2021	255.79
			34778	66005	Check	1	3788		KEY CLUB INTERNATIONAL	Yes	No	No	USD	12/15/2021	75.00
			34764	66006	Check	1	2970		KOWARSCH, LYNETTE	Yes	No	No	USD	12/15/2021	134.93
			34747	66007	Check	1	1416		LIFE SECURITY AND CONTROL	Yes	No	No	USD	12/15/2021	138.00
			34753	66008	Check	1	2232		LOWE'S	Yes	No	No	USD	12/15/2021	191.44
			34748	66009	Check	1	1584		MID-AMERICAN RESEARCH CHEMICAL	Yes	No	No	USD	12/15/2021	1,137.83
			34767	66010	Check	1	3097	REMIT	MINNEAPOLIS OXYGEN COMPANY	Yes	No	No	USD	12/15/2021	314.01
			34742	66011	Check	1	06336		MN INDUSTRIES	Yes	No	No	USD	12/15/2021	5,099.27
			34743	66012	Check	1	06635		MUSIC IN MOTION	Yes	No	No	USD	12/15/2021	653.40

## ISD 695-Chisholm Check Register by Bank and Check

Batch	Co	Bank	Pymt No	Check No	Pay Type	Grp	Code	Rcd	Vendor	Print	Recon	Void	Currency	Pmt/Void Date	Amount
0695		10	34744	66013	Check	1	06850		NORTHEAST SERVICE COOPERATIV	Yes	No	No	USD	12/15/2021	720.00
			34758	66014	Check	1	2736		NORTHERN BUSINESS PRODUCTS II	Yes	No	No	USD	12/15/2021	795.45
			34769	66015	Check	1	3190		PERSONS, DANIELL	Yes	No	No	USD	12/15/2021	145.00
			34750	66016	Check	1	2019	REMIT	PURCHASE POWER	Yes	No	No	USD	12/15/2021	10.94
			34751	66017	Check	1	2051		RANGER YEARBOOK	Yes	No	No	USD	12/15/2021	67.00
			34754	66018	Check	1	2272		RYANS INDEPENDENT ELECTRIC	Yes	No	No	USD	12/15/2021	1,265.00
			34766	66019	Check	1	3062		RYKS, KEVIN	Yes	No	No	USD	12/15/2021	145.00
			34771	66020	Check	1	3202		SANTELLI, CORY	Yes	No	No	USD	12/15/2021	145.00
			34774	66021	Check	1	3418		SCAIA, KEVIN R	Yes	No	No	USD	12/15/2021	145.00
			34749	66022	Check	1	1808		ST LOUIS CTY AUDITOR	Yes	No	No	USD	12/15/2021	535.11
			34745	66023	Check	1	09645		SULLIVAN SUPPLY	Yes	No	No	USD	12/15/2021	367.06
			34763	66024	Check	1	2963		TEACHERS ON CALL	Yes	No	No	USD	12/15/2021	4,665.82
			34765	66025	Check	1	3001		THOMPSON, DAWN	Yes	No	No	USD	12/15/2021	135.00
			34746	66026	Check	1	10137		UNITED TRUCK BODY CO INC	Yes	No	No	USD	12/15/2021	26.54
			34768	66027	Check	1	3116		WAGNER, JON	Yes	No	No	USD	12/15/2021	145.00
			34782	66028	Check	1	2614		CW TECHNOLOGY	Yes	No	No	USD	12/15/2021	863.00
			34783	66029	Check	1	3679		ZOOM VIDEO COMMUNICATIONS INC	Yes	No	No	USD	12/15/2021	3,043.15
			34785	66030	Check	1	3765		ALEX KACZOR	Yes	No	No	USD	12/16/2021	893.35
			34784	66031	Check	1	2963		TEACHERS ON CALL	Yes	No	No	USD	12/16/2021	3,957.40
			34786	66032	Check	1	3792		NATHAN LUTZKA	Yes	No	No	USD	12/16/2021	913.35
			34787	66033	Check	1	3387		BLUE CROSS BLUE SHIELD OF MN B	Yes	No	No	USD	12/16/2021	11,570.00
			34788	66034	Check	1	3376		CROTTEAU, JENNIFER	Yes	No	No	USD	12/16/2021	158.55
			34789	66035	Check	1	3793		BETHEL UNIVERSITY	Yes	No	No	USD	12/21/2021	4,815.00
			34790	66036	Check	1	00150	R1	ARAMARK	Yes	No	No	USD	12/23/2021	1,134.76
			34792	66037	Check	1	2705		HORIZON COMMERCIAL POOL SUPP	Yes	No	No	USD	12/23/2021	1,476.85
			34791	66038	Check	1	2101		MN ENERGY RESOURCES CORP	Yes	No	No	USD	12/23/2021	59.15
			34793	66039	Check	1	2320		MEDICARE BLUE RX	Yes	No	No	USD	12/28/2021	17,588.60
			34807	66040	Check	1	1041	REMIT	ALLDATA	Yes	No	No	USD	12/29/2021	975.00
			34813	66041	Check	1	2423		AMAZON CAPITAL SERVICES	Yes	No	No	USD	12/29/2021	124.36
			34826	66042	Check	1	3794		BHS	Yes	No	No	USD	12/29/2021	75.00
			34814	66043	Check	1	2502		BLACK BEAR BAKERY	Yes	No	No	USD	12/29/2021	193.70
			34815	66044	Check	1	2614		CW TECHNOLOGY	Yes	No	No	USD	12/29/2021	863.00
			34810	66045	Check	1	1797		DELL MARKETING LP	Yes	No	No	USD	12/29/2021	354.00
			34806	66046	Check	1	10255		DEX MEDIA	Yes	No	No	USD	12/29/2021	134.00
			34795	66047	Check	1	02569		ECOLAB PEST ELIMINATION DIV	Yes	No	No	USD	12/29/2021	534.71
			34818	66048	Check	1	3081		FAIRVIEW HEALTH SERVICES	Yes	No	No	USD	12/29/2021	140.00
			34797	66049	Check	1	03570		GRAINGER	Yes	No	No	USD	12/29/2021	489.19
			34798	66050	Check	1	03577		GRAYBAR <sub>28</sub>	Yes	No	No	USD	12/29/2021	66.96
			34821	66051	Check	1	3255	R1	HUDL	Yes	No	No	USD	12/29/2021	2,250.00
			34799	66052	Check	1	04212		INAC, INC	Yes	No	No	USD	12/29/2021	59,365.75
			34825	66053	Check	1	3785	R1	INNOVATIVE OFFICE SOLUTIONS LLC	Yes	No	No	USD	12/29/2021	399.00

### ISD 695-Chisholm Check Register by Bank and Check

Batch	Co	Bank	Pymt No	Check No	Pay Type	Grp	Code	Rcd	Vendor	Print	Recon	Void	Currency	Pmt/Void Date	Amount
0695		10	34823	66054	Check	1	3689		IRON RANGE PLUMBING AND HEATIN	Yes	No	No	USD	12/29/2021	195.00
			34824	66055	Check	1	3714		IRON RANGE TOWING	Yes	No	No	USD	12/29/2021	150.00
			34800	66056	Check	1	04226		ISD #0318 GRAND RAPIDS	Yes	No	No	USD	12/29/2021	105.00
			34811	66057	Check	1	1842		ISD #6076 NORTHLAND LEARNING	Yes	No	No	USD	12/29/2021	77,241.73
			34796	66058	Check	1	03553		JUBILEE FOODS	Yes	No	No	USD	12/29/2021	18.27
			34801	66059	Check	1	05206	R1	L & M SUPPLY FLEET SUPPLY	Yes	No	No	USD	12/29/2021	35.94
			34809	66060	Check	1	1416		LIFE SECURITY AND CONTROL	Yes	No	No	USD	12/29/2021	300.00
			34819	66061	Check	1	3097	REMIT	MINNEAPOLIS OXYGEN COMPANY	Yes	No	No	USD	12/29/2021	42.25
			34827	66062	Check	1	3795		MINNESOTA TRUE TEAM TRACK	Yes	No	No	USD	12/29/2021	130.00
			34802	66063	Check	1	06336		MN INDUSTRIES	Yes	No	No	USD	12/29/2021	522.40
			34803	66064	Check	1	06850		NORTHEAST SERVICE COOPERATIV	Yes	No	No	USD	12/29/2021	4,048.24
			34804	66065	Check	1	07230		OSI ENVIRONMENTAL	Yes	No	No	USD	12/29/2021	100.00
			34805	66066	Check	1	08317		RANGE MENTAL HEALTH CENTER IN	Yes	No	No	USD	12/29/2021	1,077.75
			34822	66067	Check	1	3363		RANGE SPORTS	Yes	No	No	USD	12/29/2021	39.00
			34820	66068	Check	1	3175		SCHELDE, JULIE	Yes	No	No	USD	12/29/2021	444.00
			34812	66069	Check	1	2121	2	SCHMITT MUSIC - REMIT	Yes	No	No	USD	12/29/2021	275.00
			34816	66070	Check	1	2859	REMIT	SHRED IT USA	Yes	No	No	USD	12/29/2021	477.63
			34808	66071	Check	1	1088		SPECIAL SCHOOL DISTRICT NO. 1	Yes	No	No	USD	12/29/2021	110.32
			34817	66072	Check	1	2963		TEACHERS ON CALL	Yes	No	No	USD	12/29/2021	4,747.76
			34828	66073	Check	1	05731		MADISON NATIONAL LIFE INS CO	Yes	No	No	USD	12/30/2021	2,406.97
Bank Total: 10														\$436,447.07	
Report Total:														\$436,447.07	

## ISD 695-Chisholm Check Register by Bank and Check

Batch	Co	Bank	Pymt No	Check No	Pay Type	Grp	Code	Rcd	Vendor	Print	Recon	Void	Currency	Pmt/Void Date	Amount
0695		10	34785	66030	Check	1	3765		ALEX KACZOR	Yes	No	No	USD	12/16/2021	893.35
			34807	66040	Check	1	1041	REMIT	ALLDATA	Yes	No	No	USD	12/29/2021	975.00
			34709	65931	Check	1	2423		AMAZON CAPITAL SERVICES	Yes	No	No	USD	12/07/2021	2,496.22
			34756	65982	Check	1	2423		AMAZON CAPITAL SERVICES	Yes	No	No	USD	12/15/2021	452.31
			34813	66041	Check	1	2423		AMAZON CAPITAL SERVICES	Yes	No	No	USD	12/29/2021	124.36
			34780	65983	Check	1	3790		ANDREW FORBORT	Yes	No	No	USD	12/15/2021	191.00
			34772	65984	Check	1	3220		APG MEDIA OF MN	Yes	No	No	USD	12/15/2021	124.80
			34790	66036	Check	1	00150	R1	ARAMARK	Yes	No	No	USD	12/23/2021	1,134.76
			34761	65985	Check	1	2919		ARROWHEAD DRIVERS TRAINING LT	Yes	No	No	USD	12/15/2021	270.00
			34728	65972	Check	1	2354		ATT MOBILITY	Yes	No	No	USD	12/09/2021	94.38
			34755	65986	Check	1	2354		ATT MOBILITY	Yes	No	No	USD	12/15/2021	453.94
			34701	65932	Check	1	1944		AVIBEN	Yes	No	No	USD	12/07/2021	117.03
			34736	65987	Check	1	00610		BARK DESIGN INC	Yes	No	No	USD	12/15/2021	453.83
			34776	65988	Check	1	3702		BAUDHUIN, CHRIS	Yes	No	No	USD	12/15/2021	193.00
			34789	66035	Check	1	3793		BETHEL UNIVERSITY	Yes	No	No	USD	12/21/2021	4,815.00
			34826	66042	Check	1	3794		BHS	Yes	No	No	USD	12/29/2021	75.00
			34779	65989	Check	1	3789		BILL BRINK	Yes	No	No	USD	12/15/2021	209.00
			34814	66043	Check	1	2502		BLACK BEAR BAKERY	Yes	No	No	USD	12/29/2021	193.70
			34734	65978	Check	1	3387		BLUE CROSS BLUE SHIELD OF MN B	Yes	No	No	USD	12/14/2021	270.40
			34735	65979	Check	1	3387		BLUE CROSS BLUE SHIELD OF MN B	Yes	No	No	USD	12/14/2021	2,794.00
			34787	66033	Check	1	3387		BLUE CROSS BLUE SHIELD OF MN B	Yes	No	No	USD	12/16/2021	11,570.00
			34759	65990	Check	1	2774		BUHL WATER CO INC	Yes	No	No	USD	12/15/2021	80.00
			34685	65933	Check	1	01612		C & J INTERIORS	Yes	No	No	USD	12/07/2021	250.10
			34760	65991	Check	1	2870		CASEY'S	Yes	No	No	USD	12/15/2021	65.96
			34773	65992	Check	1	3384		CHEERLEADING.COM	Yes	No	No	USD	12/15/2021	98.32
			34737	65993	Check	1	01600		CHISHOLM CITY OF	Yes	No	No	USD	12/15/2021	4,805.57
			34729	65973	Check	1	2668		CONSOLIDATED COMMUNICATIONS	Yes	No	No	USD	12/09/2021	1,057.52
			34788	66034	Check	1	3376		CROTTEAU, JENNIFER	Yes	No	No	USD	12/16/2021	158.55
			34782	66028	Check	1	2614		CW TECHNOLOGY	Yes	No	No	USD	12/15/2021	863.00
			34815	66044	Check	1	2614		CW TECHNOLOGY	Yes	No	No	USD	12/29/2021	863.00
			34698	65934	Check	1	1797		DELL MARKETING LP	Yes	No	No	USD	12/07/2021	860.00
			34810	66045	Check	1	1797		DELL MARKETING LP	Yes	No	No	USD	12/29/2021	354.00
			34806	66046	Check	1	10255		DEX MEDIA	Yes	No	No	USD	12/29/2021	134.00
			34777	65994	Check	1	3754		DONALD W LALONDE	Yes	No	No	USD	12/15/2021	90.00
			34704	65935	Check	1	2191		DULUTH RANGE COMMUNICATIONS	Yes	No	No	USD	12/07/2021	212.50
			34752	65995	Check	1	2191		DULUTH RANGE COMMUNICATIONS	Yes	No	No	USD	12/15/2021	170.00
			34795	66047	Check	1	02569		ECOLAB PEST ELIMINATION DIV	Yes	No	No	USD	12/29/2021	534.71
			34762	65996	Check	1	2944		EDUCATION INNOVATION PARTNERS	Yes	No	No	USD	12/15/2021	209.68
			34738	65997	Check	1	03018		EXCEL BUSINESS SYSTEM	Yes	No	No	USD	12/15/2021	8,425.40
			34818	66048	Check	1	3081		FAIRVIEW HEALTH SERVICES	Yes	No	No	USD	12/29/2021	140.00
			34770	65998	Check	1	3191		FLOERSHEIM, WILLIAM	Yes	No	No	USD	12/15/2021	183.00

## ISD 695-Chisholm Check Register by Bank and Check

Batch	Co	Bank	Pymt No	Check No	Pay Type	Grp	Code	Rcd	Vendor	Print	Recon	Void	Currency	Pmt/Void Date	Amount
0695		10	34757	65999	Check	1	2548		FOLLET SCHOOL SOLUTIONS INC	Yes	No	No	USD	12/15/2021	2,270.19
			34723	65936	Check	1	3739		GOOGLE VOICE INC	Yes	No	No	USD	12/07/2021	54.03
			34687	65937	Check	1	03570		GRAINGER	Yes	No	No	USD	12/07/2021	928.38
			34797	66049	Check	1	03570		GRAINGER	Yes	No	No	USD	12/29/2021	489.19
			34724	65938	Check	1	3764		GRAND RAPIDS HIGH SCHOOL	Yes	No	No	USD	12/07/2021	125.00
			34688	65939	Check	1	03577		GRAYBAR	Yes	No	No	USD	12/07/2021	635.10
			34798	66050	Check	1	03577		GRAYBAR	Yes	No	No	USD	12/29/2021	66.96
			34708	65940	Check	1	2399		HIBBING CROSS COUNTRY	Yes	No	No	USD	12/07/2021	160.00
			34697	65941	Check	1	1375		HOGLUND BUS CO INC	Yes	No	No	USD	12/07/2021	87.58
			34792	66037	Check	1	2705		HORIZON COMMERCIAL POOL SUPP	Yes	No	No	USD	12/23/2021	1,476.85
			34821	66051	Check	1	3255	R1	HUDL	Yes	No	No	USD	12/29/2021	2,250.00
			34689	65942	Check	1	04213		INAC, INC	Yes	No	No	USD	12/07/2021	67.30
			34740	66000	Check	1	04213		INAC, INC	Yes	No	No	USD	12/15/2021	15.90
			34799	66052	Check	1	04212		INAC, INC	Yes	No	No	USD	12/29/2021	59,365.75
			34719	65943	Check	1	3457		INGENSA INC.	Yes	No	No	USD	12/07/2021	23,115.50
			34825	66053	Check	1	3785	R1	INNOVATIVE OFFICE SOLUTIONS LLC	Yes	No	No	USD	12/29/2021	399.00
			34823	66054	Check	1	3689		IRON RANGE PLUMBING AND HEATIN	Yes	No	No	USD	12/29/2021	195.00
			34824	66055	Check	1	3714		IRON RANGE TOWING	Yes	No	No	USD	12/29/2021	150.00
			34800	66056	Check	1	04226		ISD #0318 GRAND RAPIDS	Yes	No	No	USD	12/29/2021	105.00
			34741	66001	Check	1	04300		ISD #0701 HIBBING	Yes	No	No	USD	12/15/2021	6,667.00
			34699	65944	Check	1	1842		ISD #6076 NORTHLAND LEARNING	Yes	No	No	USD	12/07/2021	7,587.50
			34811	66057	Check	1	1842		ISD #6076 NORTHLAND LEARNING	Yes	No	No	USD	12/29/2021	77,241.73
			34730	65974	Check	1	3721		ISD# 2909 ROCK RIDGE PUBLIC SCH	Yes	No	No	USD	12/09/2021	150.00
			34781	66002	Check	1	3791		JACE JANEZICH	Yes	No	No	USD	12/15/2021	250.00
			34775	66003	Check	1	3459		JOHNSON, PHILLIP	Yes	No	No	USD	12/15/2021	145.00
			34703	65945	Check	1	2183		JOLA & SOPP EXCAVATING INC	Yes	No	No	USD	12/07/2021	5,650.00
			34686	65946	Check	1	03553		JUBILEE FOODS	Yes	No	No	USD	12/07/2021	39.27
			34739	66004	Check	1	03553		JUBILEE FOODS	Yes	No	No	USD	12/15/2021	255.79
			34796	66058	Check	1	03553		JUBILEE FOODS	Yes	No	No	USD	12/29/2021	18.27
			34778	66005	Check	1	3788		KEY CLUB INTERNATIONAL	Yes	No	No	USD	12/15/2021	75.00
			34764	66006	Check	1	2970		KOWARSCH, LYNETTE	Yes	No	No	USD	12/15/2021	134.93
			34722	65947	Check	1	3715		KRISTEN HOHEISEL	Yes	No	No	USD	12/07/2021	427.50
			34691	65948	Check	1	05206	R1	L & M SUPPLY FLEET SUPPLY	Yes	No	No	USD	12/07/2021	89.42
			34801	66059	Check	1	05206	R1	L & M SUPPLY FLEET SUPPLY	Yes	No	No	USD	12/29/2021	35.94
			34690	65949	Check	1	05201		LAKESHORE	Yes	No	No	USD	12/07/2021	66.48
			34747	66007	Check	1	1416		LIFE SECURITY AND CONTROL	Yes	No	No	USD	12/15/2021	138.00
			34809	66060	Check	1	1416		LIFE SECURITY AND CONTROL	Yes	No	No	USD	12/29/2021	300.00
			34753	66008	Check	1	2232		LOWE'S 31	Yes	No	No	USD	12/15/2021	191.44
			34828	66073	Check	1	05731		MADISON NATIONAL LIFE INS CO	Yes	No	No	USD	12/30/2021	2,406.97
			34692	65950	Check	1	05971		MARY'S LAKE STREET FLORAL	Yes	No	No	USD	12/07/2021	83.00
			34726	65975	Check	1	06326		MCEA EXECUTIVE OFFICE	Yes	No	No	USD	12/09/2021	152.00

## ISD 695-Chisholm Check Register by Bank and Check

Batch	Co	Bank	Pymt No	Check No	Pay Type	Grp	Code	Rcd	Vendor	Print	Recon	Void	Currency	Pmt/Void Date	Amount
0695	10		34793	66039	Check	1	2320		MEDICARE BLUE RX	Yes	No	No	USD	12/28/2021	17,588.60
			34748	66009	Check	1	1584		MID-AMERICAN RESEARCH CHEMICAL	Yes	No	No	USD	12/15/2021	1,137.83
			34714	65951	Check	1	3097	REMIT	MINNEAPOLIS OXYGEN COMPANY	Yes	No	No	USD	12/07/2021	369.49
			34767	66010	Check	1	3097	REMIT	MINNEAPOLIS OXYGEN COMPANY	Yes	No	No	USD	12/15/2021	314.01
			34819	66061	Check	1	3097	REMIT	MINNEAPOLIS OXYGEN COMPANY	Yes	No	No	USD	12/29/2021	42.25
			34733	65980	Check	1	2971		MINNESOTA LIFE INSURANCE	Yes	No	No	USD	12/14/2021	2,024.24
			34827	66062	Check	1	3795		MINNESOTA TRUE TEAM TRACK	Yes	No	No	USD	12/29/2021	130.00
			34693	65952	Check	1	06294		MN ASSOCIATION OF SEC SCHOOL F	Yes	No	No	USD	12/07/2021	160.00
			34702	65953	Check	1	2060		MN DEPT OF HEALTH	Yes	No	No	USD	12/07/2021	1,920.00
			34727	65976	Check	1	2101		MN ENERGY RESOURCES CORP	Yes	No	No	USD	12/09/2021	25,587.40
			34791	66038	Check	1	2101		MN ENERGY RESOURCES CORP	Yes	No	No	USD	12/23/2021	59.15
			34694	65954	Check	1	06336		MN INDUSTRIES	Yes	No	No	USD	12/07/2021	948.55
			34742	66011	Check	1	06336		MN INDUSTRIES	Yes	No	No	USD	12/15/2021	5,099.27
			34802	66063	Check	1	06336		MN INDUSTRIES	Yes	No	No	USD	12/29/2021	522.40
			34706	65955	Check	1	2278		MN TELECOMMUNICATIONS	Yes	No	No	USD	12/07/2021	1,199.39
			34743	66012	Check	1	06635		MUSIC IN MOTION	Yes	No	No	USD	12/15/2021	653.40
			34710	65956	Check	1	2511		MUSIC IS ELEMENTARY	Yes	No	No	USD	12/07/2021	36.90
			34707	65957	Check	1	2303		NAPA AUTO PARTS	Yes	No	No	USD	12/07/2021	117.63
			34786	66032	Check	1	3792		NATHAN LUTZKA	Yes	No	No	USD	12/16/2021	913.35
			34744	66013	Check	1	06850		NORTHEAST SERVICE COOPERATIV	Yes	No	No	USD	12/15/2021	720.00
			34803	66064	Check	1	06850		NORTHEAST SERVICE COOPERATIV	Yes	No	No	USD	12/29/2021	4,048.24
			34758	66014	Check	1	2736		NORTHERN BUSINESS PRODUCTS II	Yes	No	No	USD	12/15/2021	795.45
			34732	65981	Check	1	06979		NORTHERN MINNESOTA DENTAL, INC	Yes	No	No	USD	12/14/2021	8,614.00
			34804	66065	Check	1	07230		OSI ENVIRONMENTAL	Yes	No	No	USD	12/29/2021	100.00
			34769	66015	Check	1	3190		PERSONS, DANIELL	Yes	No	No	USD	12/15/2021	145.00
			34716	65958	Check	1	3119	REMIT	PNC BANK C/O FIRST BOOK	Yes	No	No	USD	12/07/2021	207.90
			34750	66016	Check	1	2019	REMIT	PURCHASE POWER	Yes	No	No	USD	12/15/2021	10.94
			34695	65959	Check	1	08317		RANGE MENTAL HEALTH CENTER IN	Yes	No	No	USD	12/07/2021	342.75
			34805	66066	Check	1	08317		RANGE MENTAL HEALTH CENTER IN	Yes	No	No	USD	12/29/2021	1,077.75
			34822	66067	Check	1	3363		RANGE SPORTS	Yes	No	No	USD	12/29/2021	39.00
			34751	66017	Check	1	2051		RANGER YEARBOOK	Yes	No	No	USD	12/15/2021	67.00
			34705	65960	Check	1	2272		RYANS INDEPENDENT ELECTRIC	Yes	No	No	USD	12/07/2021	15,900.00
			34754	66018	Check	1	2272		RYANS INDEPENDENT ELECTRIC	Yes	No	No	USD	12/15/2021	1,265.00
			34713	65961	Check	1	3062		RYKS, KEVIN	Yes	No	No	USD	12/07/2021	193.00
			34766	66019	Check	1	3062		RYKS, KEVIN	Yes	No	No	USD	12/15/2021	145.00
			34718	65962	Check	1	3202		SANTELLI, CORY	Yes	No	No	USD	12/07/2021	145.00
			34771	66020	Check	1	3202		SANTELLI, CORY	Yes	No	No	USD	12/15/2021	145.00
			34774	66021	Check	1	3418		SCAIA, KEVIN R	Yes	No	No	USD	12/15/2021	145.00
			34820	66068	Check	1	3175		SCHELDE, JULIE	Yes	No	No	USD	12/29/2021	444.00
			34812	66069	Check	1	2121	2	SCHMITT MUSIC - REMIT	Yes	No	No	USD	12/29/2021	275.00
			34725	65963	Check	1	3786		SHELLY MAKI	Yes	No	No	USD	12/07/2021	90.00

## ISD 695-Chisholm Check Register by Bank and Check

Batch	Co	Bank	Pymt No	Check No	Pay Type	Grp	Code	Rcd	Vendor	Print	Recon	Void	Currency	Pmt/Void Date	Amount
0695		10	34816	66070	Check	1	2859	REMIT	SHRED IT USA	Yes	No	No	USD	12/29/2021	477.63
			34808	66071	Check	1	1088		SPECIAL SCHOOL DISTRICT NO. 1	Yes	No	No	USD	12/29/2021	110.32
			34749	66022	Check	1	1808		ST LOUIS CTY AUDITOR	Yes	No	No	USD	12/15/2021	535.11
			34745	66023	Check	1	09645		SULLIVAN SUPPLY	Yes	No	No	USD	12/15/2021	367.06
			34720	65964	Check	1	3628		SWANK MOTION PICTURES INC	Yes	No	No	USD	12/07/2021	750.00
			34717	65965	Check	1	3164		TAUS, DAVID	Yes	No	No	USD	12/07/2021	67.50
			34712	65966	Check	1	2963		TEACHERS ON CALL	Yes	No	No	USD	12/07/2021	2,336.52
			34763	66024	Check	1	2963		TEACHERS ON CALL	Yes	No	No	USD	12/15/2021	4,665.82
			34784	66031	Check	1	2963		TEACHERS ON CALL	Yes	No	No	USD	12/16/2021	3,957.40
			34817	66072	Check	1	2963		TEACHERS ON CALL	Yes	No	No	USD	12/29/2021	4,747.76
			34765	66025	Check	1	3001		THOMPSON, DAWN	Yes	No	No	USD	12/15/2021	135.00
			34711	65967	Check	1	2657	REMIT	TIERNEY BROTHERS INC	Yes	No	No	USD	12/07/2021	43,416.00
			34731	65977	Check	1	3787		TRES INC	Yes	No	No	USD	12/09/2021	35,221.20
			34721	65968	Check	1	3713		TREVENA, BRENT	Yes	No	No	USD	12/07/2021	145.00
			34700	65969	Check	1	1931		TRIMARK INDUSTRIAL	Yes	No	No	USD	12/07/2021	338.86
			34696	65970	Check	1	1340		ULINE	Yes	No	No	USD	12/07/2021	558.95
			34746	66026	Check	1	10137		UNITED TRUCK BODY CO INC	Yes	No	No	USD	12/15/2021	26.54
			34715	65971	Check	1	3116		WAGNER, JON	Yes	No	No	USD	12/07/2021	145.00
			34768	66027	Check	1	3116		WAGNER, JON	Yes	No	No	USD	12/15/2021	145.00
			34783	66029	Check	1	3679		ZOOM VIDEO COMMUNICATIONS INC	Yes	No	No	USD	12/15/2021	3,043.15
Bank Total: 10														\$436,447.07	
Report Total:														\$436,447.07	

Adopted:  
Revised: December 2021  
Approved January 27, 2020

Orig. 1995  
Reviewed: December 2019

INDEPENDENT SCHOOL DISTRICT NO. 695  
CHISHOLM, MINNESOTA

**POLICY 510.4**

**CHISHOLM ATHLETIC AND NON-ATHLETIC ACTIVITY FEES**

Any student who participates in athletics and non-athletic activities (One-act, junior high dramatics, senior high dramatics, Speech, Knowledge Bowl, etc.) in School District 695, Chisholm Minnesota will:

1. The student completes the application for Educational Benefits or is on the Direct Certification List and qualifies for Free Lunch; the district will pay the activity fee.
2. The student completes the application for Educational Benefits and qualifies for reduced lunch; ½ (one-half) of the activity fee will be paid by the district.

The athletic and non-athletic fee schedule follows:

<u>ATHLETICS</u>		<u>NON-ATHLETICS</u>
\$90.00	GRADES 9 – 12	\$40.00
\$70.00	GRADES 8 and below	\$40.00
\$350.00	MAXIMUM FAMILY FEE	\$350.00

**FEES MUST BE PAID DURING REGISTRATION BEFORE  
THE FIRST CONTEST OR PUBLIC APPEARANCE**

Payment made payable to ISD #695 can be brought to the Activities Director or payment can be made online.

**REFUNDS**

- A. When injury or illness prevent continuation in the sport, a refund will be made (provided the injury or illness is substantiated by a physician's statement) up until the time of the first contest or public appearance.
- B. When a transfer is made out of Independent School District #695, a refund will be made up until the time of the first contest or public appearance
- C. Cut from the squad by the coach: A refund will be made until the time of the first contest or public appearance
- D. Student quitting the activity: NO refund.
- E. With the first contest or public appearance, NO refund will be made for any reason due to the fact that the benefits of the activity will have accrued to the amount of the fee to the student.

## **REFUND FORMS**

**Refund forms can be obtained from the Activities Director and must be filled out before a refund can be obtained.**

**INDEPENDENT SCHOOL DISTRICT NO. 695  
CHISHOLM, MINNESOTA**

**POLICY 513.1**

**CLASS SCHEDULE CHANGE POLICY**

**I. PURPOSE**

The purpose of this policy is designed to promote academic success at Chisholm High School. Students are given curriculum and registration information each spring. Students are given adequate time to select the courses of their choice. All efforts are made to assign the courses requested.

This policy is in place because teaching positions are based on registration. Once students register, course sections are cut and staffing positions are determined. If we allow students to change their minds about course selection not only, does it undermine the integrity of the registration process, but more importantly, class sizes become very imbalanced.

For a student who fails a course affecting graduation requirements, every effort is made to replace the requirement in the student's schedule. Due to class sizes, other schedule changes are not always possible. Any exception to the above may be made if circumstances are unique, and there is mutual agreement between administration, teachers, and the family.

**II. GENERAL STATEMENT OF POLICY**

Students must request a meeting with the counselor for any schedule changes. The counselor will consider each request. A completed request does not guarantee a schedule change. Factors such as class size, availability of classes and/or appropriate placement supersede all requests.

**A. Students are allowed to:**

1. switch elective classes on their schedules
2. rearrange classes within their schedules

After the sixth(6<sup>th</sup>) day of the semester actions(A1 and A2) are not allowed.

**B. Student wanting to DROP from a class INTO A STUDY HALL**

1. Prior to the tenth (10<sup>th</sup>) day of the semester, NO penalty, class will not appear on transcript
2. After the tenth (10<sup>th</sup>) day of the semester, YES penalty, class will appear on transcripts as a "W" which has the same impact on GPA/class rank as a letter grade of an "F".
3. Course fees are non-refundable
4. Grades 9-10 cannot have more than one study hall each semester
5. Grades 11-12 cannot have more than two study halls each semester

**C. Student wanting to Change one Course for another Course**

1. Moving up or down a level within a course (e.g., Advanced Algebra to Algebra) OR (e.g., Algebra to Advanced Algebra)
  - a. prior to the tenth (10<sup>th</sup>) day of the semester
  - b. based on students' ability as determined by previous work, standardized test scores, and review of course load.
  - c. Students exchanging classes are responsible to make up all work

**III. IMPORTANT INFORMATION REGARDING SCHEDULE CHANGES**

It is every STUDENT'S RESPONSIBILITY to make sure the schedule change does not affect graduation requirements or NCAA eligibility.

**A. Seniors**

Schedule changes may affect college admissions decisions. Before changing a schedule, it is the student's responsibility check with the admissions office of any college to which you have applied or been accepted to see if the change will affect your admission standing.

**B. Concurrent Enrollment Students**

1. Students may add a course through the fifth (5<sup>th</sup>) day of the semester.
2. Students are allowed to drop any course through the fifth (5<sup>th</sup>) day of the semester. Dropped courses do not appear on the transcript and do not impact academic standing.
3. Students are allowed to withdraw from a course through the fifteenth (15<sup>th</sup>) day of the semester. Withdrawal courses appear on a transcript as a "W" and have a direct impact on academic standing.

Students must check with High School Counsel.

**C. Post-Secondary Enrollment Options (PSEO)**

Students have the opportunity to enroll in Post-Secondary Programs for high school credit. PSEO classes are off-campus and students must provide their own transportation. Students must see the High School Counselor to discuss the options and criteria for participation in the program.

## Resignation

1 message

---

**George Rajkovich** <grajkovich@chisholm.k12.mn.us>

Thu, Dec 30, 2021 at 4:44 PM

To: Adrian Norman <anorman@chisholm.k12.mn.us>, Lisa Aldrich <laldrich@chisholm.k12.mn.us>

Adrian and Lisa

I'm writing to formally put in my resignation for ISD 695 has chief engineer. My last day employment will be January 18th 2022. Thank you for the last two years of employment.

Thank you  
George Rajkovich



Adrian Norman <[anorman@chisholm.k12.mn.us](mailto:anorman@chisholm.k12.mn.us)>

---

## Fwd: yearbook advisor

1 message

---

**Mark Morrison** <[mmorrison@chisholm.k12.mn.us](mailto:mmorrison@chisholm.k12.mn.us)>

Sun, Jan 2, 2022 at 1:55 PM

To: Lisa Aldrich <[laldrich@chisholm.k12.mn.us](mailto:laldrich@chisholm.k12.mn.us)>, Adrian Norman <[anorman@chisholm.k12.mn.us](mailto:anorman@chisholm.k12.mn.us)>

Can we get this on the next board agenda and then post it?

Sent from my iPhone

Begin forwarded message:

**From:** elizabeth carroll <[ellieabeth@me.com](mailto:ellieabeth@me.com)>

**Date:** January 1, 2022 at 11:10:41 AM CST

**To:** Mark Morrison Cell phone <[mmorrison@chisholm.k12.mn.us](mailto:mmorrison@chisholm.k12.mn.us)>

**Cc:** [laldrich@chisholm.k12.mn.us](mailto:laldrich@chisholm.k12.mn.us), elizabeth carroll <[ecarroll@chisholm.k12.mn.us](mailto:ecarroll@chisholm.k12.mn.us)>

**Subject:** yearbook advisor

Dear Mr. Morrison,

Please accept my notice if resignation for the yearbook advisor. Thank you for allowing me to serve in this position. I will finish this years position. Thank you for your time.

Kind Regards,  
Betsy Carroll





10250 Valley View Road, Suite 147  
Eden Prairie, MN 55344

Phone: 952-941-9830  
Web: www.aimle.com

Adrian Norman,

**Chisholm Public Schools  
Price Quotation  
December 10, 2021**

**Daktronics Dual Time Shot Clocks and Light Strips**

<u>Description</u>	<u>Quant.</u>	<u>Price</u>	<u>Total</u>
1. Daktronics BB-2115-13 (LED) Dual Time shot clocks. Set of two displays (Size 2'-4"H x 2'-5"W x 6"D)	1	\$3468.00	\$3468.00
2. Daktronics LED light strips Set of two strips	1	1938.00	1938.00
Estimated Freight			140.00
Installation and set up*			1050.00
<b>Total</b>			<b>\$6596.00</b>

\*Includes mounting brackets, mounting shot clocks to back board poles, install signal wire from scoreboard to shot clocks, mounting light strips with bracket, test out and training. Electrical must be installed by licensed electrician, also an airlift must be provided for installation.

**Options**

Wireless Gen6 control option (two receivers) \$860.00

**Other Information**

Warranty (1) one year manufacture  
Lead time (7) seven weeks  
Payment 30% with order, balance due net (30) thirty days  
Prices valid (60) sixty days  
**Prices do not include MN State and City Sales Taxes**

**Brian Grandstrand  
AIM Electronics, Inc.**

**Adrian Norman  
Chisholm Public Schools**

# DAKTRONICS BB-2115 PRODUCT SPECIFICATIONS



This indoor single-sided LED basketball game clock and shot clock timer displays game time to 99:59 and shot times up to a value of 99 seconds. It can also count down from any preset time between 0 and 99 seconds. During the last minute of the period, game time is displayed to 1/10 of a second. A hand-held start/stop/reset switch is included with purchase. Shot clock shown with PanaView® digits.

POWER (120 VAC)*	UNCRATED WEIGHT	DIMENSIONS
50 Watts, 0.5 Amp	30 lb (14 kg)	2'-4" H x 2'-5" W x 6" D (711 mm, 737 mm, 152 mm)

\*Models with 240 VAC power at half the indicated amperage are also offered (International Use Only).

## DIGITS

- Game clock digits are 7" (178 mm) high. Shot clock digits are 13" (330 mm) high.
- Game clock digits are amber. Shot clock digits are red.
- Select PanaView® or UniView® LED digit technology (see [SL-04729](#)).

## DISPLAY COLOR

Choose from 150+ colors (from Martin Senour® paint book) at no additional cost.

## CONSTRUCTION

Durable, lightweight aluminum Tuff Sport® cabinet withstands high-velocity impact from air-filled sports balls without the need for protective screens.

## PRODUCT SAFETY APPROVAL

ETL-listed, tested to CSA standards, and CE-labeled **for indoor use only**

## OPERATING TEMPERATURES

- Display: -22° to 122° Fahrenheit (-30° to 50° Celsius)
- Console: 32° to 130° Fahrenheit (0° to 54° Celsius)

# DAKTRONICS BB-2115 PRODUCT SPECIFICATIONS

CONTROL CONSOLE	CONTROL OPTIONS
<b>All Sport® 5000*</b> (see <a href="#">SL-03991</a> )	<b>Wired (standard):</b> One-pair shielded cable of 22 AWG minimum is required. A cover plate with mounted connector and standard 2" x 4" x 2" (51 mm x 102 mm x 51 mm) outlet box is provided. Connector mates with signal cable from control console.
	<b>Wireless (optional):</b> 2.4 GHz spread spectrum radio features 64 non-interfering channels and 8 broadcast groups (see <a href="#">SL-04370</a> ).

\* Controller not included with standard purchase; timer(s) are typically controlled by the same console controlling the basketball scoreboard(s).

## LIGHT STRIP OUTPUT

Timer features outputs to control Daktronics end-of-period backboard LED light strips, such as the BB-2135 (sold separately).

## HORN

An internal horn sounds automatically when shot clock counts down to zero with a sound that is distinctly different from that of the game-clock horn.

## GENERAL INFORMATION

Timer provides game and shot clock timing capabilities. 100% solid state electronics are housed in an all aluminum cabinet. Timer arrives at the site fully assembled. Mounting hardware not included. Specifications and pricing are subject to change without notice.

## OPTIONS & ACCESSORIES

- Carrying handle
- Portable signal kit
- End-of-period backboard light strips (see [SL-05965](#))
- Visual horn indicator (see [SL-02093](#) or [SL-05489](#))
- Protective screen (see [SL-02551](#))
- Suspension installation kit

## FOR ADDITIONAL INFORMATION

- Mechanical Specifications: DWG-3267938 (attached)
- Component Locations: DWG-3272582 (attached)
- Architectural Specifications: See [SL-04795](#)
- Installation Manual: See [DD2481645](#)
- Service Manual: See [DD2481648](#)

# BB-2115/3115

**NOTES:**

1. MOUNTING HARDWARE IS NOT PROVIDED.
2. SEE DRAWING A-91230 FOR SUGGESTIONS ON MOUNTING TO CEILING-SUSPENDED BACKSTOPS.
3. FOR PORTABLE BACKSTOPS, CONTACT THE BACKSTOP MANUFACTURER FOR MOUNTING HARDWARE.

WEIGHTS	
SHIPPING WEIGHT	MOUNTING WEIGHT
40 LBS (18 KG)	30 LBS (14 KG)

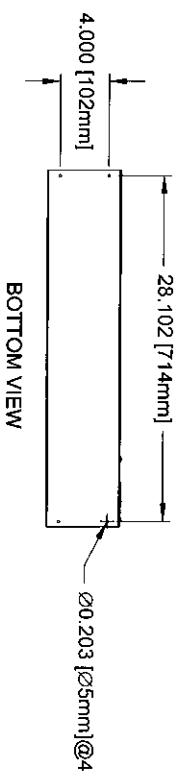
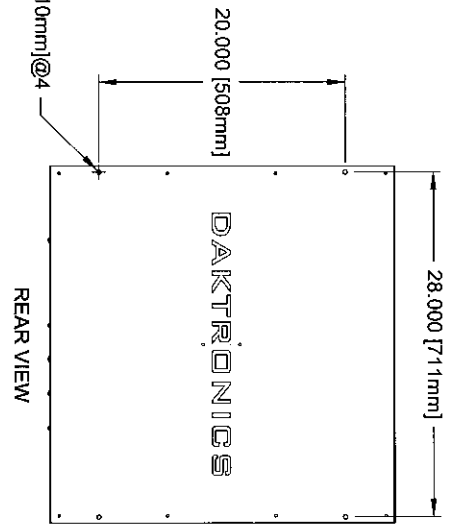
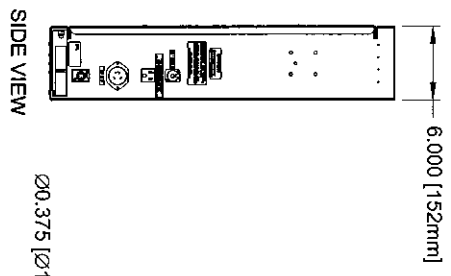
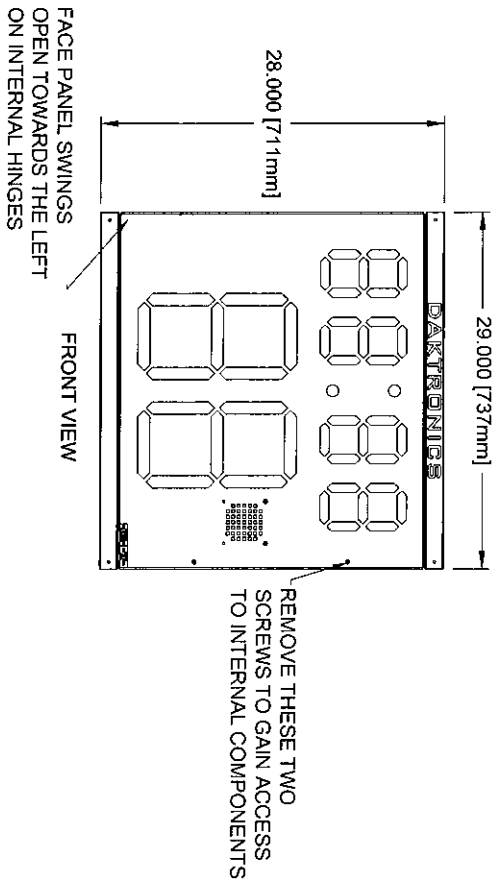
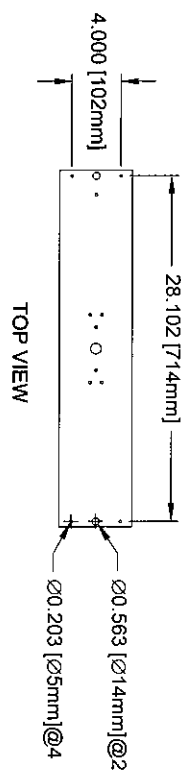
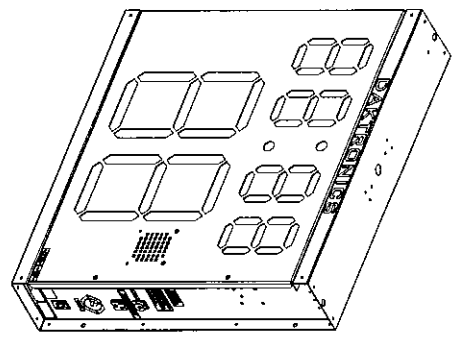

ISOMETRIC VIEW

TUFF SPORT® IS A COPYRIGHT OF DAKTRONICS

<p>THE CONCEPTS EXPRESSED AND DETAILS SHOWN ON THIS DRAWING ARE FOR INFORMATION ONLY AND ARE NOT TO BE USED FOR CONSTRUCTION. ANY MEANS WITHOUT THE EXPRESS WRITTEN CONSENT OF DAKTRONICS, INC. OR ITS WHOLLY OWNED SUBSIDIARIES. COPYRIGHT 2016 DAKTRONICS, INC. (USA)</p>		<p>THIRD ANGLE PROJECTION</p>	
<p><b>PROJECT:</b> TUFF SPORT® SCOREBOARDS</p>			
<p><b>TITLE:</b> MECHANICAL SPEC: BB-2115/3115</p>			
<p><b>DATE:</b> 29 JAN 16</p>		<p><b>DIM UNITS:</b> INCHES [MILLIMETERS]</p>	
<p><b>SCALE:</b> 1=15</p>		<p><b>DO NOT SCALE DRAWING</b></p>	
<p><b>DESIGN:</b> BPETERSON</p>		<p><b>JOB NO.:</b></p>	
<p><b>DRAWN:</b> PSCHROE</p>		<p><b>FUNC - TYPE - SIZE</b></p>	
<p>P1237</p>		<p>E - 10 - A</p>	
<p><b>3267938</b></p>			<p>SHEET</p>
<p>REV</p>			<p>00</p>

DIGIT, SIGNAL AND POWER SPECIFICATIONS:

# BB-2115

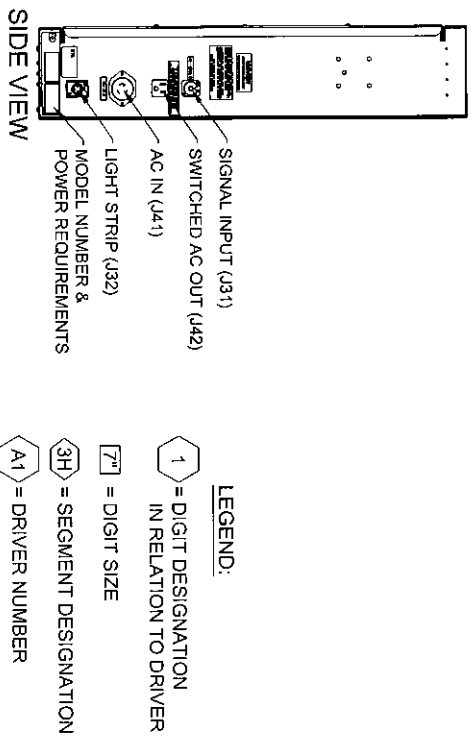
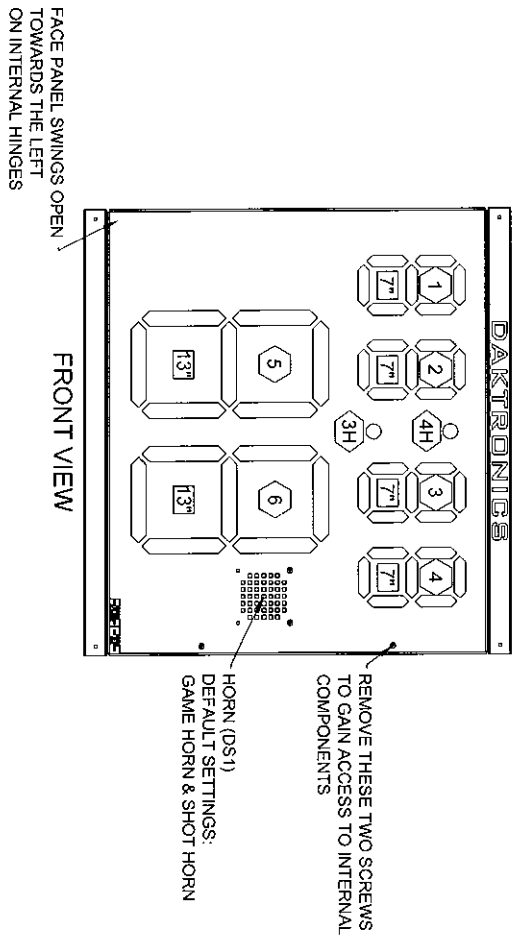

COMPONENT LOCATIONS:

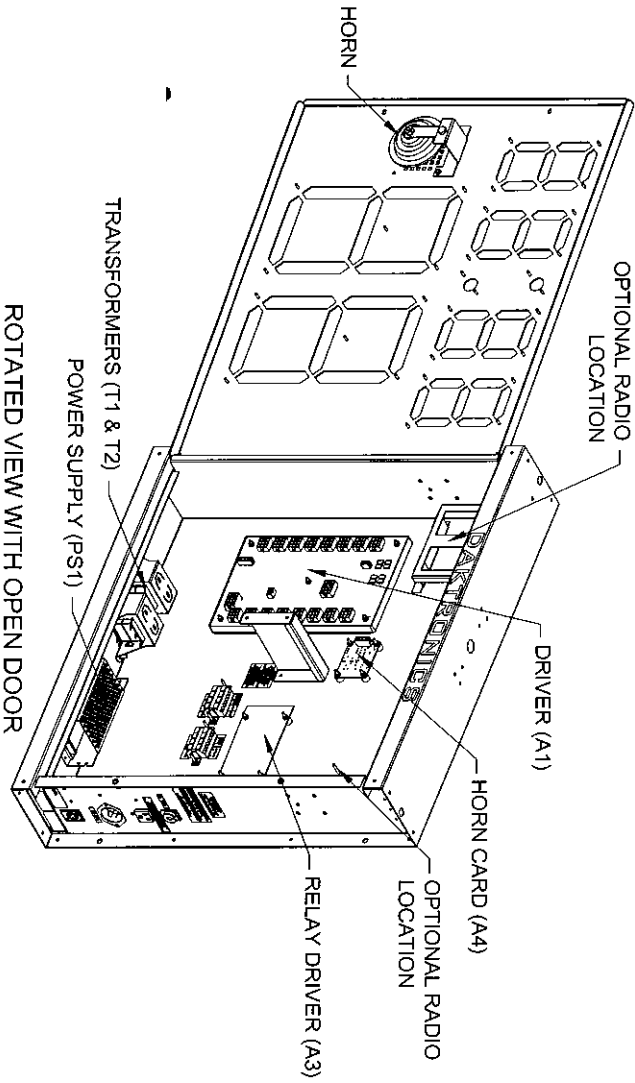

NOTES:

1. A3 BOARD CAPABILITIES ARE GAME HORN, SHOT HORN, CLK = STOP, CLK = 0. J32/J42 (TOGETHER), & HORN CAN BE SET TO DIFFERENT VALUES IF REQUIRED.
2. TO CHANGE DEFAULT FUNCTION OF HORN, ENABLE OTHER SEGMENTS, OR CHANGE LIGHT STRIP OPTIONS, REFER TO DWG A-179151.

TUFF SPORT® IS A COPYRIGHT OF DAKTRONICS

<p>THE COMMENTS EXPRESSED AND DETAILS SHOWN ON THIS DRAWING ARE THE PROPERTY OF DAKTRONICS, INC. OR ITS WHOLLY OWNED SUBSIDIARIES. ANY REUSE OR REPRODUCTION OF THIS DRAWING WITHOUT THE EXPRESS WRITTEN CONSENT OF DAKTRONICS, INC. OR ITS WHOLLY OWNED SUBSIDIARIES. COPYRIGHT 2016 DAKTRONICS, INC. (USA)</p>		<p>THIRD ANGLE PROJECTION</p>	
<p>PROJECT: TUFF SPORT® SCOREBOARDS</p>			
<p>TITLE: COMPONENT LOCATION: BB-2115</p>			
<p>DATE: 01 FEB 16</p>		<p>DIM UNITS: INCHES [MILLIMETERS]</p>	
<p>SCALE: 1=12</p>		<p>DO NOT SCALE DRAWING</p>	
<p>DESIGN: CHAMILLI</p>		<p>JOB NO. P1237</p>	
<p>DRAWN: PSCHROE</p>		<p>FUNC. TYPE - SIZE E - 10 - A</p>	
		<p>SHEET 00</p>	
		<p>REV</p>	
		<p>3272582</p>	



# DAKTRONICS LTS-BB PRODUCT SPECIFICATIONS

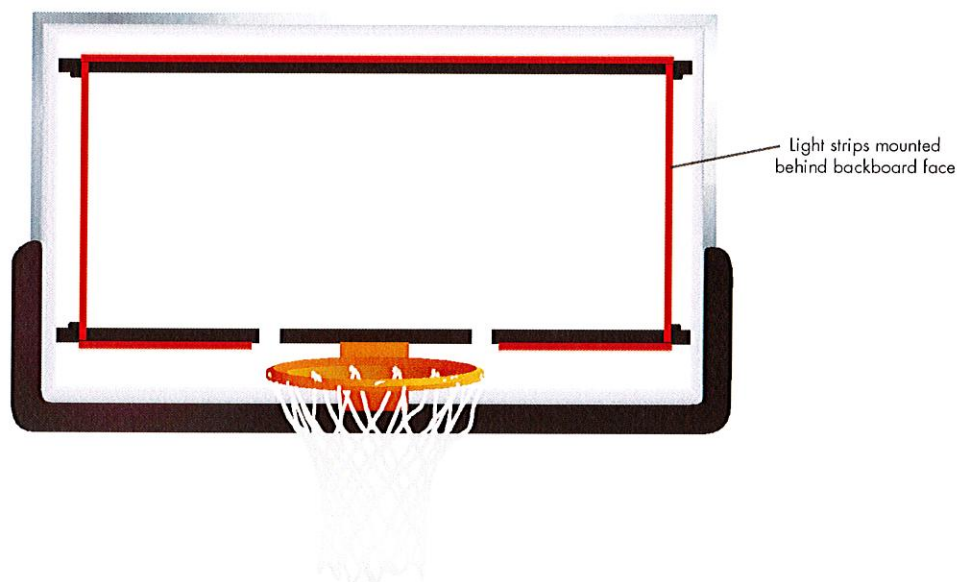

This backboard LED light strip kit acts as a visual indicator to communicate with basketball players, fans and officials. A strip of red LEDs behind the face of the backboard lights up when the game clock reaches zero. Alternately, the light strip can be programmed to illuminate when the game (or shot clock) horn sounds or while the clock is stopped. This kit is designed to fit typical backboard models used at high school and collegiate levels. **Backboards are not provided by Daktronics.**

## DIMENSIONS

Light strips (without mounting hardware) are 0.82" (21 mm) tall and 0.38" (10 mm) deep. Light strip across the top is 62" (1475 mm) wide. The two light strips on the bottom are each 18" (457 mm) wide. The lengths of the two light strips along the sides vary depending on the height of backboard, either 29" (737 mm) for a 42" (1067 mm) tall backboard or 35" (889 mm) for a 48" (1219 mm) tall backboard.

## WEIGHT

25 lb (11 kg) per pair of packaged light strip kits

## POWER

Primary Voltage: 120 VAC  
Secondary Voltage: 16 VDC  
100 Watts

## LED COLOR

Red

## CONSTRUCTION

Durable plastic composite material with aluminum brackets

## PAINT COLOR

Mounting brackets are painted semi-gloss black.

## CONTROL

Daktronics shot clock or LED light strip controller; 18 AWG jacketed signal cable with 3-pin XLR male and female ends

## GENERAL INFORMATION

Specifications and pricing are subject to change without notice.

## OPTIONS

- Visual Horn Indicator Kit (high school applications only) – light strips illuminate only when scoreboard horn sounds.

## FOR ADDITIONAL INFORMATION

- Specifications: DWG-4662008 (attached)
- Connection Detail: DWG-3285852 (attached)
- Architectural Specifications: See [DD4708265](#)
- Display Manual: [DD4692853](#)

[WWW.DAKTRONICS.COM](http://WWW.DAKTRONICS.COM) E-MAIL: [SALES@DAKTRONICS.COM](mailto:SALES@DAKTRONICS.COM)

201 Daktronics Drive, PO Box 5128, Brookings, SD 57006  
Phone: 1-800-325-8766 or 605-692-0200 Fax: 605-697-4746  
DD4703928 100520 Page 1 of 3 Copyright © 2020 Daktronics, Inc.

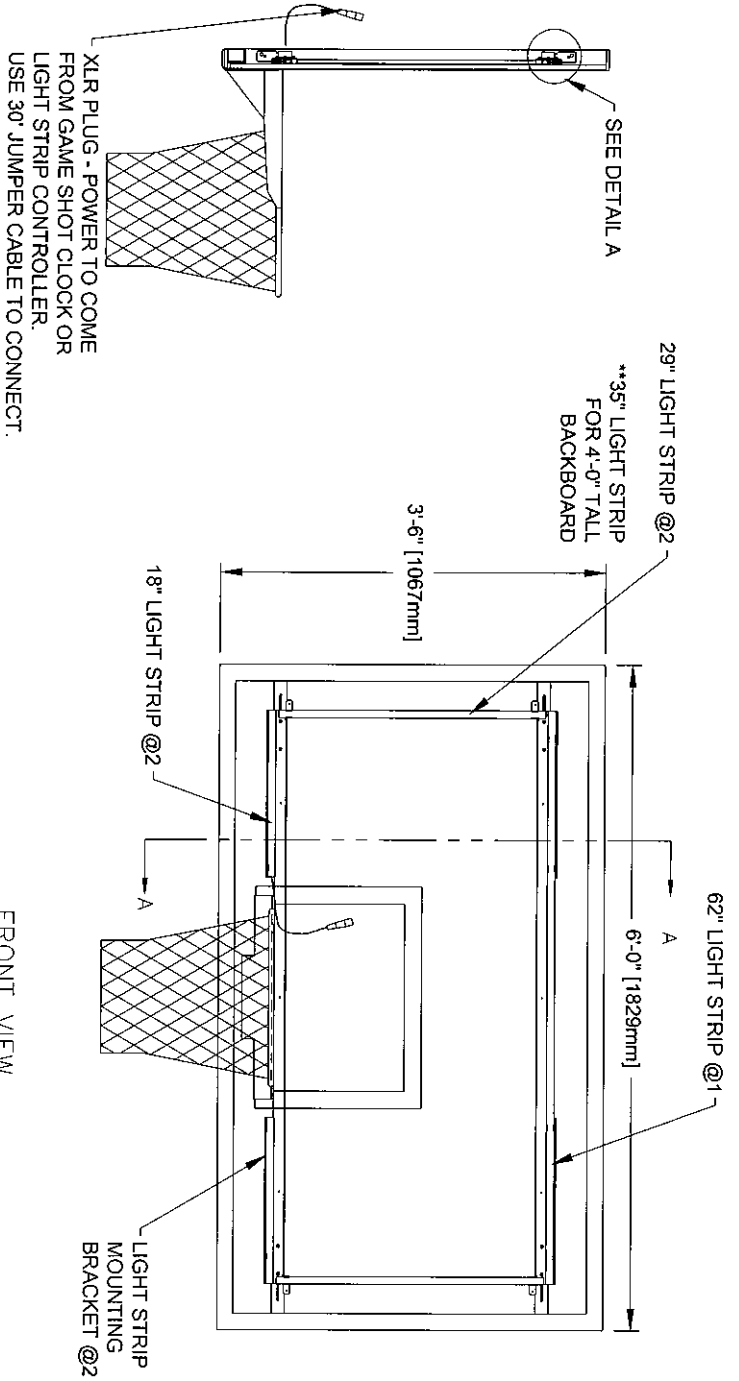

FRONT VIEW

SECTION: A-A

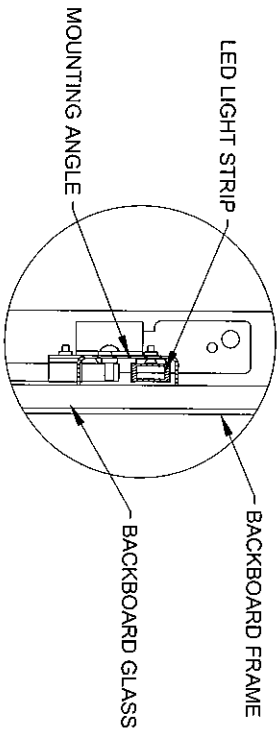

DETAIL: A

- ELECTRICAL SPECS FOR LED LIGHT STRIP**
- PRIMARY VOLTAGE = 120VAC
  - SECONDARY VOLTAGE = 16VDC
  - POWER = 100W

<b>DAKTRONICS</b>		THE CONCEPTS EXPRESSED AND DETAILS SHOWN ON THIS DRAWING ARE CONFIDENTIAL AND PROPRIETARY. DO NOT REPRODUCE BY ANY MEANS WITHOUT THE EXPRESS WRITTEN CONSENT OF DAKTRONICS, INC. (USA). COPYRIGHT © 2020 DAKTRONICS, INC. (USA)		THIRD ANGLE PROJECTION	
PROJECT:	INDOOR SCOREBOARDS	TITLE:	SPECS: UNIVERSAL BACKBOARD LIGHTS STRIPS		
DATE:	07 APR 20	DWG UNITS:	INCHES [MILLIMETERS]	SHEET	REV
SCALE:	1/20	DO NOT SCALE DRAWING			00
DESIGN:	DOPPELT	JOB NO.:	P1237	FUNC. TYPE: SIZE	F. 10 - A
DRAWN:	DOPPELT	<b>4662008</b>			

**DETAIL 'A'**  
RETRACTABLE BASKETBALL HOOP DETAILS

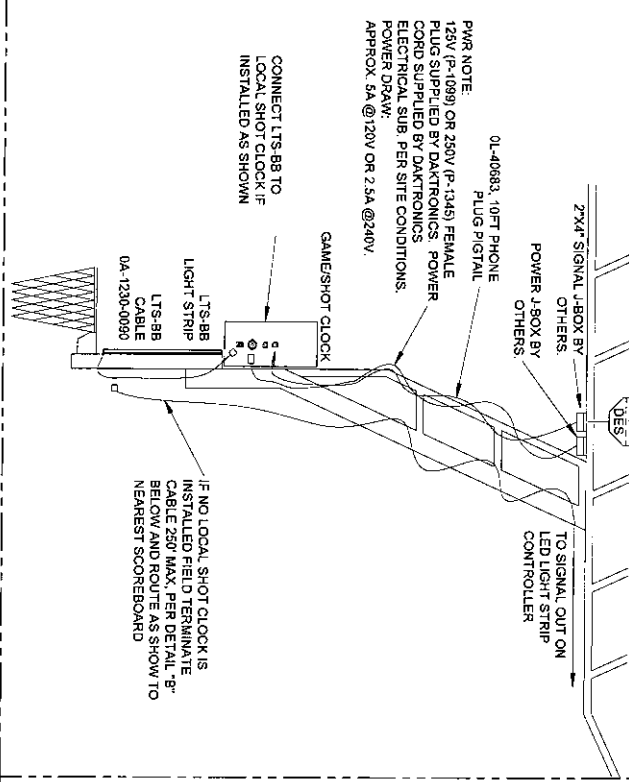

**DETAIL 'B'**

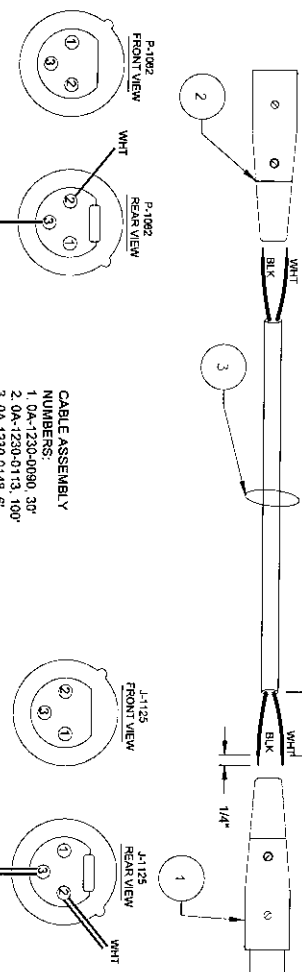

- CABLE ASSEMBLY NUMBERS:**  
 1. 0A-1230-0090 30'  
 2. 0A-1230-0113 100'  
 3. 0A-1230-0148 6'  
 4. 0A-1230-0168 50'

- INSTRUCTIONS:**  
 1. STRIP 3/4" OF JACKET OFF EACH END OF W-1351.  
 2. STRIP 1/4" OF WHITE AND BLACK WIRES ON BOTH ENDS.  
 3. SLIDE THE JACKET FOR J-1125 OVER ONE END, SOLDER WHT WIRE TO PIN 2 OF J-1125; SOLDER BLK WIRE TO PIN 3 OF J-1125.  
 4. SLIDE JACKET UP TO THE JACK AND SECURE.  
 5. TAKE THE JACKET FROM P-1082 AND SLIDE OVER OTHER END OF CABLE SOLDER WHT WIRE TO PIN 2 OF P-1082; SOLDER BLK WIRE TO PIN 3 OF P-1082.  
 6. SLIDE THE JACKET UP TO THE PLUG AND SECURE.

ITEM	QTY	UNITS	DESCRIPTION	DAK PART #	PREFERRED MFG	PART #
1	1	EA	JACK 3 PIN FEM. XLR, SLDR	J-1125	NEURBK	NC3FK-B
2	1	EA	PLUG 3 PIN MAL. XLR, SLDR	P-1082	NEURBK	NCMAK-B
3	BCM	IN	CABLE 2 COND 16AWG SO TYPE CABLE	W-1351	ANY	ANY

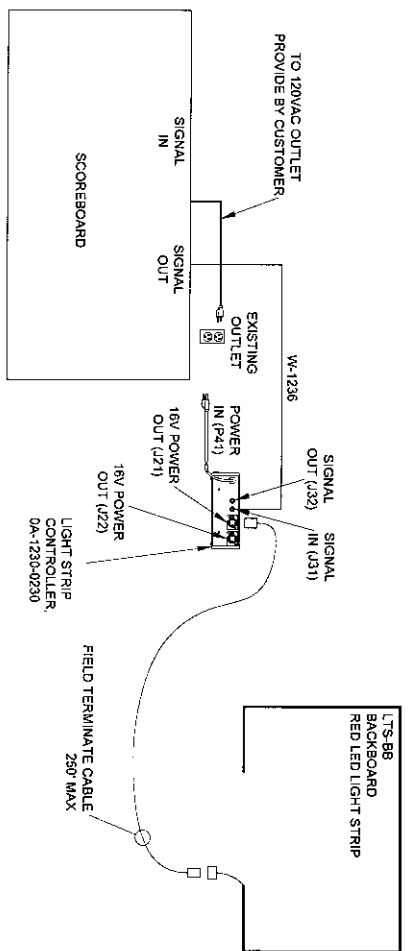

REV	DATE	DESCRIPTION	BY
03	22 JUL 20	UPDATED DR 2135 TO I-1888 AND N-02741.3	JSE
02	20 JUN 17	UPDATED FROM 1888 TO I-1888 AND N-02741.3	MD
01	18 NOV 16	CREATED FOR LIGHT STRIP	MD

- CONTROLLER NEEDS TO BE FASTENED TO WALL OR SHELF LOCAL TO THE SCOREBOARD
- CONNECT POWER CORD ON LIGHT STRIP CONTROLLER TO A 120VAC SWITCHED OUTPUT.
- CONNECT THE XLR CABLE FROM J21 ON THE CONTROLLER TO THE XLR JACK ON THE LED LIGHT STRIP
- REFERENCE ED-17823 FOR INSTALLATION
- LTS-BB LIGHT STRIP CONTROLLER:  
 0A-1230-0230  
 0A-1230-0233 KIT  
 230VOLT  
 0A-1230-0231
- COLORSMART CONTROLLER:  
 0A-1389-0081  
 0A-1389-0106 KIT

**DATACON**

THE COMPANY'S PRACTICES AND DETAILS SHOWN ON THIS DRAWING ARE SUBJECT TO CHANGE WITHOUT NOTICE. THE DRAWING IS TO BE USED ONLY FOR THE PROJECT AND SITE SPECIFICALLY IDENTIFIED ON THE DRAWING. THE DRAWING IS NOT TO BE REPRODUCED OR COPIED IN ANY MANNER WITHOUT THE WRITTEN PERMISSION OF DATACON.

PROJECT: CONNECTION DETAIL 188-2135 TO REMOTE CONTROLLER  
 TITLE: CONNECTION DETAIL LED LIGHT STRIP CONTROLLER  
 DATE: 8 FEB 16  
 SCALE: NONE  
 DESIGNER: HUBNER  
 CHECKER: MRUFER

DO NOT SCALE DRAWING

JOB NO: P1237  
 DATE: 11-16-16  
 SHEET: 03

3285852





FOOTBALL  
 BASKETBALL  
 VOLLEYBALL  
 SOCCER  
 BASEBALL  
 LACROSSE  
 TENNIS  
 SOFTBALL  
 UNIFORMS  
 TRACK&FIELD  
 STRENGTH&  
 FITNESS  
 WRESTLING  
 SPORTS MED  
 SPEED  
 AGILITY  
 SCOREBOARDS  
 BENCHES&BLEACHERS  
 COACHING  
 AQUATICS

**BSN SPORTS Product Pricing:** School shall be able to purchase products at the following discounts:

- Nike/UA Team Apparel/Stock Uniforms 35% off Retail Price
- Nike/UA Custom/Digital/Armourfuse Uniforms 35% off Retail Price
- Nike/UA Team Footwear 35% off Retail Price
- BSN Direct Products Min. 15% off Catalog Price
- BSN Catalog Branded Products Min. 10% off Catalog Price

All Custom Uniforms and Footwear will be priced separately. Custom apparel, decorated apparel and footwear from any other manufacturers offered by BSN SPORTS will be at team discount pricing. Decoration charges are not included in the above stock discounts, but are included in custom.

BSN SPORTS Direct Products are identified in our catalog with a black star icon next to the product code. BSN SPORTS catalog branded products are products distributed by BSN from a manufacturer such as Wilson, Spalding, Rawlings, etc.

**My Team Shop:** BSN SPORTS' online player pay site is required to be used by all Varsity programs. All other programs including club sports and organizations are also encouraged to participate. **All MTS sales including club and organizations will count towards rebate goals.**

**Uniform Terms and Order Deadline:** School is required to purchase all uniforms from BSN on the standard uniform rotation established by the School. School shall place orders with BSN for Custom uniforms by: (i) March 1 for fall sports; (ii) June 1 for winter sports; and (iii) December 1 for spring sports. Stock uniforms and BSN Victory Uniforms should be ordered 5 weeks prior to necessary in-hand date to ensure delivery.

**Service Plan:** The designated BSN SPORTS Sales Professional will commit to being on campus and meeting as requested by the Director of Athletics. BSN is committed to a "team service approach", to include, but not limited to a Customer Service Representative, a Territory Manager, Product Managers, and a Regional Sales Manager to assist the Sales Professional. School will also be set up with BSN Online Billing if approved by the School.

**Shipping:** The School will pay shipping charges on all orders.

**Terms and Conditions:** Only products purchased through BSN SPORTS Sales Pro at the BSN SPORTS Product Pricing will be eligible for the Product Rebate. The School and Athletic Program must be current on all payment obligations to BSN to be eligible for the Product Rebate.

**Term:** The duration of this agreement is three (3) years from **January 1, 2022 to December 31, 2024** ("Term").



Acknowledged and Agreed to:

**CHISHOLM HIGH SCHOOL**

\_\_\_\_\_  
SIGNATURE

\_\_\_\_\_  
PRINTED NAME/TITLE

\_\_\_\_\_  
DATE



**BSN SPORTS**

\_\_\_\_\_  
SIGNATURE

\_\_\_\_\_  
PRINTED NAME/TITLE

\_\_\_\_\_  
DATE

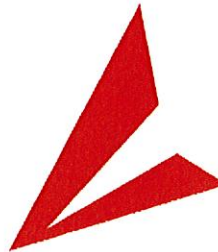

FOOTBALL  
BASKETBALL  
VOLLEYBALL  
SOCCER  
BASEBALL  
LACROSSE  
TENNIS  
SOFTBALL  
UNIFORMS  
TRACK&FIELD  
STRENGTH&  
FITNESS  
WRESTLING  
SPORTS MED  
SPEED  
AGILITY  
SCOREBOARDS  
BENCHES&BLEACHERS  
COACHING  
AQUATICS

# Pricing Proposal



**Date:** December 17, 2021

**Customer Name:** Chisholm Independent School District No. 695

**Address:** 300 3rd Ave SW  
Chisholm, Minnesota 55719-2064

**Product:** Student Information System

**Natl. Client Solutions Manager:** Mindee Peterson

**E-mail:** Mindee.Peterson@sourcewelltech.org

**Phone:** +1 651-999-6339

**Start Date:** 1/1/2022

**End Date:** 6/30/2023

**Term (years):** 1

TOTAL FIRST YEAR INVESTMENT - \$ 4,800.00

Product Description	Quantity	Unit Price	Discount	Total Price*
Ongoing Advantage	1	\$ 4,800.00		\$ 4,800.00

**PROPOSAL DOES NOT INCLUDE TAXES, TAX EMEMPT ENTITIES NEED TO PROVIDE THEIR TAX-EXEMPT FORM OR CERTIFICATE. IF NO TAX-EXEMPT FORM OR CERTIFICATE IS PROVIDED, TAX WILL BE CHARGED ON THE FINAL INVOICE.**

*This Pricing Proposal is not a binding legal agreement between Customer and Sourcewell Technology. It is intended to be used as a basis for the parties to negotiate a final, written agreement such as a Software Description Schedule or Statement of Work, which will become a binding legal agreement upon execution by both parties.*

# Pricing Proposal



**Date:** December 17, 2021

**Customer Name:** Chisholm Independent School District No. 695

**Address:** 300 3rd Ave SW  
Chisholm, Minnesota 55719-2064

**Product:** Student Information System

**Natl. Client Solutions Manager:** Mindee Peterson

**E-mail:** Mindee.Peterson@sourcewelltech.org

**Phone:** +1 651-999-6339

**Start Date:** 12/1/2021

**End Date:** 11/30/2022

**Term (years):** 1

TOTAL FIRST YEAR INVESTMENT - \$ 1,750.00

Product Description	Quantity	Unit Price	Discount	Total Price*
Consulting Services	10	\$ 175.00		\$ 1,750.00

**PROPOSAL DOES NOT INCLUDE TAXES, TAX EMEMPT ENTITIES NEED TO PROVIDE THEIR TAX-EXEMPT FORM OR CERTIFICATE. IF NO TAX-EXEMPT FORM OR CERTIFICATE IS PROVIDED, TAX WILL BE CHARGED ON THE FINAL INVOICE.**

*This Pricing Proposal is not a binding legal agreement between Customer and Sourcewell Technology. It is intended to be used as a basis for the parties to negotiate a final, written agreement such as a Software Description Schedule or Statement of Work, which will become a binding legal agreement upon execution by both parties.*



## Ongoing Advantage – Professional Services and Support

Our unique implementation approach is centered around building a true partnership with the school districts we support. Our team of specialists at Sourcewell Technology has over 100 collective years' experience in school systems and we are committed to your success. PowerSchool's Student Information System (SIS) is a leading software solution for educational institutions, providing innovation and easy-to-use technology. Coupling this system with our dedicated team will help you maximize your technology and its impact.

### Ongoing Advantage – Annual Consulting Services

- **12 Hours – Consulting Hours** beginning on initial date of scheduling (“Scheduling Date”) for a period of 18 months (Virtual, subject to availability). Your bank of Consulting Hours can be utilized in a variety of ways to support your implementation. From onsite, 1:1 training, to new-hire orientation, we are committed to ensuring that you have the training and support needed to ensure an effective, ongoing Student Information System (SIS) implementation. We will work closely with you to identify training needs and utilize an implementation plan to drive ongoing success.
- Account Manager assigned by territory for your convenience, as a one-point contact for inquiries related to your contract(s) with Sourcewell Technology.

### Ongoing Advantage – Ongoing Included Services

- **MARSS Reporting**
  - Sourcewell Technology (SWT) will act as your district’s MARSS resource center throughout the year to answer any MARSS related questions.
  - Provide a reminder to users when a reporting deadline is approaching
  - Keep you informed of updates from MDE and PowerSchool pertaining to MARSS
  - Assist with errors/warnings on the PowerSchool reports that create the A and B files
  - Assist with extracting the MARSS A and B files from PowerSchool SIS
  - Assist in troubleshooting errors and warnings once files uploaded through MARSS edit system
  - Assist with the setup necessary for MARSS reporting in PowerSchool SIS
  - Provide MARSS Best Practice recommendations
- **MCCC Reporting**
  - Provide a reminder to users when reporting deadlines are approaching.
  - Keep you informed of updates from MDE and PowerSchool pertaining to MCCC reporting.
  - Assist with setup of the local course index, staff course records, student course records.
  - Assist with extracting the MCCC files from PowerSchool.
  - Assist in troubleshooting errors and warnings.
- **Carl Perkins Reporting**
  - Provide a reminder to users when reporting deadlines are approaching.
  - Keep you informed of updates from MDE and PowerSchool pertaining to Carl Perkins reporting.
  - Assist with extracting the Carl Perkins files from PowerSchool.
  - Assist in troubleshooting issues with the Carl Perkins extract.
- **EdFi Reporting**
  - Assist your district in planning an EdFi implementation.
  - Assist your district as you go through the phases of the EdFi implementation.
  - Assist you in reviewing EdFi versus MARSS data.
  - Keep you informed of updates from MDE and PowerSchool pertaining to EdFi reporting.
  - Assist you in troubleshooting issues with EdFi reporting.
- **DIRS Reporting**
  - Assist with the setup necessary for DIRS reporting in PowerSchool SIS
  - Provide a reminder to users when reporting deadlines are approaching.
  - Keep you informed of updates from MDE and PowerSchool pertaining to DIRS reporting.
  - Assist with the DIRS file from PowerSchool.
  - Assist in troubleshooting issues with the DIRS extract.
- **ECFE and School Readiness reporting**
  - Assist with the setup necessary for ECFE and School Readiness reporting in PowerSchool SIS
  - Provide Best Practice recommendations
  - Assisting in troubleshooting issues with reporting.
- **CRDC Reporting**
  - Provide a reminder to users when reporting deadlines are approaching.
  - Keep you informed of updates from MDE and PowerSchool pertaining to CRDC reporting.
  - Assist with extracting the CRDC Parts 1 and 2 files from PowerSchool.
  - Assist in troubleshooting data from PowerSchool.

- **PowerSchool SIS Updates** – SWT staff will assist in understanding major PowerSchool updates and how the updates may impact your district.

---

### *Additional Features and Services*

---

- **MARSS Special Interest Group**<sup>2</sup> – SWT hosts a bimonthly meeting for our MARSS Coordinators. This provides a venue for you to share ideas, challenges, and solutions with other MARSS Coordinators.

### **Consulting Services Offered** (Consulting Hours Included in Ongoing Services)

- **Consulting Hours**<sup>2</sup> – Your Ongoing Advantage Services provides a bank of hours to use on a variety of projects. Sourcewell Technology staff can provide expertise in the following areas:
  - Master Scheduling
  - Grading setup including GPA, Rank and Honor Roll
  - End of Term for SIS and Teachers
  - Standard-based grading setup
  - Data Conversion
  - Attendance Setup
  - Security Setup
  - New Year Rollover
  - Opening the School Year
  - Graduation Planner setup
  - Preparation for Kindergarten Roundup
  - Preparation for School Registration and Lottery
- **Customized Reports** - Sourcewell Technology can build customized Report Cards and Transcripts for you, as well as specialized reports that will pull the student data you need to make informed decisions.

### **Additional Services Offered** (Not Included in Ongoing Services)

- **Professional Development outside of PowerSchool** - Sourcewell Technology can provide you with professional development on topics that will make your use of PowerSchool SIS more effective. We can help you with tools such as Microsoft Excel and Google G Suite.



# PowerSchool SIS Training & Additional Support

**Staff Training:**

**Hours**

**Concentrate on overall setup with early childhood in mind:**

**8 Hours**

- School setup—what schools are defined?
- What grades are defined for each school?
- How are calendars set up?
- How is the MARSS A File set up for each school?
- How are enrollments being utilized (MARSS enrollment and EE enrollments) for these students?

---

**Concentrating on Chisholm High School (grades 7-12):**

**2 Hours**

- How are calendars set up?
- How are Bell Schedules set up and utilized?
- How are FTEs calculated and utilized?
- How are Attendance conversions impacting ADA/ADM?

<b>Available Support</b>	
--------------------------	--

**PowerSchool SIS Ongoing Advantage**

OnDemand support for your Student Information System including access to Customer Experience team, support for end of year activities and scheduling, state reporting including Ed-Fi. Advantage includes consulting hours for projects that may be used for training new hires or any project related to the SIS.

Call for Pricing

At the Independent School District No. 695 Board meeting held on January 10, 2022, in the Chisholm Public Schools Board Room, Director \_\_\_\_\_ offered the following Resolution and moved its adoption;

**RESOLUTION NO. 22-01-10**

RESOLUTION ACCEPTING \$50.00 DONATION FROM PATTY MILLER TO SUPPORT THE KEY CLUB.

RESOLUTION ACCEPTING \$500.00 DONATION FROM THE FITZPATRICK MEDIA GROUP TO SUPPORT THE MARINE SPONSORSHIP.

Independent School District No. 695 must accept donations by way of a Resolution.

IT IS HEREBY RESOLVED by Independent School District No. 695 to accept the above list of donations.

The motion to adopt the foregoing Resolution was duly supported by Director \_\_\_\_\_, and upon being put to a vote, carried as follows:

FOR ADOPTION:            Director  
                                 Director  
                                 Director  
                                 Director  
                                 Director  
                                 Director

ABSTAINING:

AGAINST ADOPTION:

ABSENT:

Passed and adopted this 10<sup>th</sup> day of January 2022.

BY ORDER OF THE SCHOOL BOARD

\_\_\_\_\_  
School District Clerk