

Shop SABRE

PLASMA QUOTATION



Prepared for Coltom, Mike

By Chad Wilson
15 July 2025

QUOTE NO. 022490-R0



21673 CEDAR AVE. LAKEVILLE, MN 55044 | 952.461.4570 | SHOPSABRE.COM



WELCOME

SIDEKICK SERIES

Thank you for exploring ShopSabre CNC Technology, a leading name in CNC Technology. Built from the ground up in Lakeville, Minnesota, ShopSabre CNC machines proudly display the “Made in the U.S.A.” logo. Every component is meticulously monitored to ensure flawless performance. We operate under the philosophy that customer service is everything, and each ShopSabre machine undergoes rigorous testing to ensure power, precision, quality, and reliability before leaving our facility.

With over 25 years of experience and more than 10,000 CNC machines in over 40 countries, ShopSabre CNC has the expertise, reputation, and technology to give you an advantage. In this quote, we will showcase what makes a ShopSabre CNC machine unique and why choosing anything else would be settling. Below, you’ll find key features and benefits

that highlight why ShopSabre CNC machines are industry-leading. If anything is unclear or if you have any questions, please reach out to me personally. I am here to use my knowledge of the technology and industry to help guide, educate, and showcase the incredible value packed into the packages we offer at ShopSabre.

As a CNC Consultant, I am non-commission driven, so let’s spend the time necessary to ensure you get exactly what you need. If you want to compare options, machines, or companies, I am happy to provide a comparative analysis for your benefit.

Thank you for considering ShopSabre CNC Technology!



INDUSTRIAL PRECISION FRAME

ShopSabre CNC frames are meticulously engineered and rigorously tested using FEA technology. Built from robust 4" x 4" structural steel tubes, our frames are welded for maximum rigidity. Each SideKick Series frame stands on 6 legs, providing superior floor contact and vibration control. These legs are cross-braced and reinforced with steel tubes at three or more points, ensuring exceptional stiffness, rigidity, and load capacity.

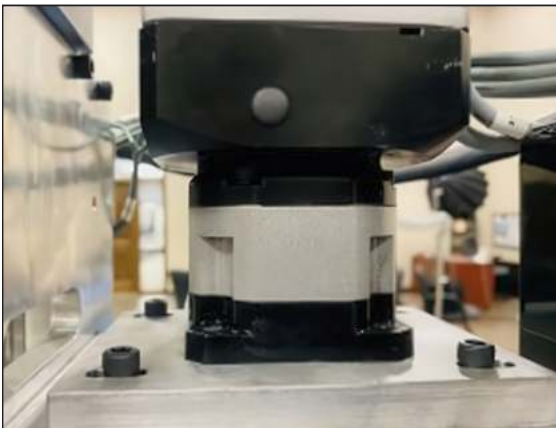

ADVANCED HYBRID MOTORS

ShopSabre SideKick machines feature advanced closed-loop hybrid motors for exceptional speed, precision, and reliability with minimal maintenance. These self-monitoring motors use encoder technology to eliminate missed steps, accuracy loss, and torque drop. Enhanced acceleration and stability ensure superior performance, particularly with thin materials and tight-tolerance cutting, while supporting longer duty cycles.

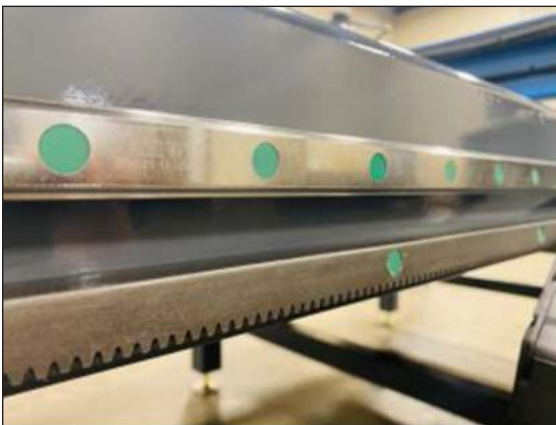

SHOPSABRE FLOATING DRIVE TECHNOLOGY

ShopSabre SideKick Series machines feature advanced XY axis large rack and pinion systems with our exclusive inverted "floating drive" gear engagement technology. This innovative design minimizes debris contamination and self-aligns for wear, enhancing gear performance and longevity while significantly reducing maintenance. Experience superior efficiency and reliability with ShopSabre's cutting-edge technology.



AEROSPACE MILLING TECHNOLOGY

ShopSabre CNC gantry systems are crafted using some of the world's most advanced aerospace milling processes, ensuring unparalleled accuracy. We precisely mill contact surfaces for bearing and rail placement, guaranteeing a rock-solid foundation. Our frames are engineered to tolerances that surpass the competition, delivering precision and reliability that set a new industry standard.



OPTIONAL TABLE CONFIGURATIONS

Every SideKick comes standard with a full bed of slats and offers blow-through, down-draft, or water table configurations (down-draft and water table options incur additional costs). Each water table includes a welded pan tested for integrity, welded slat brackets, robust ladder frame bracing, water table isolation diode technology, and advanced plasma defense water treatment. These features provide tailored solutions to enhance your machine's performance and versatility.

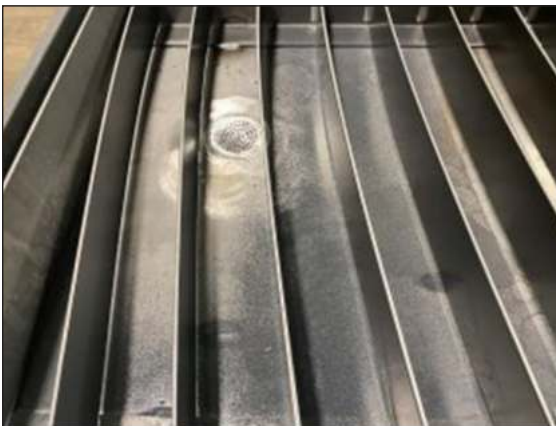

INDUSTRIAL DRAIN WITH WATER TABLE

ShopSabre CNC's water table option includes a large rear drain for quick and easy cleaning.



INDUSTRIAL Z AXIS TECHNOLOGY

ShopSabre SideKick machines feature a robust Z axis with twin rails, four high-precision bearings, and industrial-grade ball screw technology. Each plasma cutter includes advanced digital torch height control with touch distance technology for efficient cutting. Standard features include a magnetic breakaway torch mount with an integrated level for precise adjustments. Additionally, we offer an electronic torch collision detection system with proximity sensors for enhanced protection and performance.

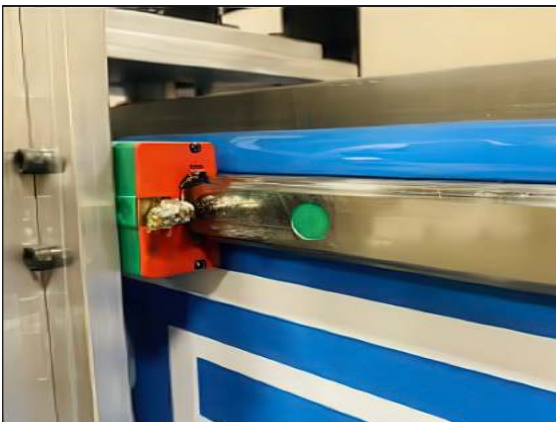

PRECISION LINEAR GUIDE TECHNOLOGY

ShopSabre CNC integrates cutting-edge 25mm linear guide rails and bearings on all axes, featuring four robust quad-bearing rollers per axis equipped with wipers. This advanced bearing technology keeps surfaces clean, enhances machine rigidity under load, and boosts performance. As a result, you benefit from improved cutting speeds, greater acceleration, and reduced maintenance, all thanks to the precision of ball bearing technology.



INDUSTRIAL PRECISION GANTRY

Our gantry construction features robust 4x10 steel tubes, designed and tested with FEA for optimal cutting force and reduced vibration. Steel's superior heat resistance ensures tight tolerances and stability, minimizing distortion from temperature changes. The wider bearing spacing supports additional tools like routers or drills and enhances cutting speeds. This heavy-duty gantry design also extends the Z axis to 8 inches, accommodating larger jobs without clearance issues.



INDUSTRIAL MACHINE CONTROL INCLUDED

Every ShopSabre machine is equipped with the industry's most intuitive controller, featuring point-and-click technology for effortless operation. It comes with at-machine CAD/CAM capabilities, an onboard diagnostic system, and a comprehensive material library. This advanced control setup enhances the customer experience, simplifies learning, and eliminates the need for a dedicated CNC operator, making it easy for anyone to achieve professional results.



ENCLOSED PLASMA WIRING

ShopSabre prioritizes quality, evident in our advanced wiring. We use industrial-grade continuous flex robotic wiring for dependable movement and durability. To address electronic noise and debris concerns, we employ shielded wiring housed in plasma-rated enclosed cable carriers. This comprehensive protection minimizes wiring issues, ensuring reliable performance and saving you time and hassle.

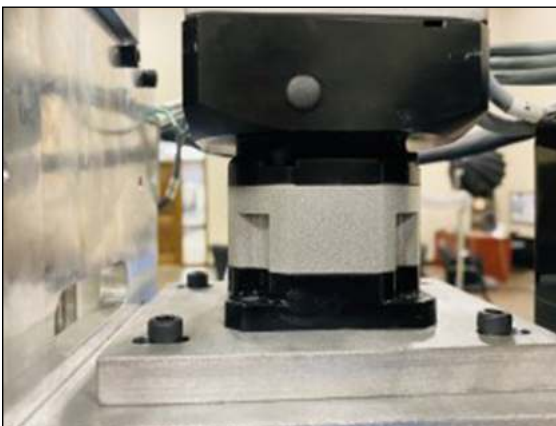

PLANETARY GEAR DRIVEN

Each ShopSabre SideKick Series plasma is equipped with a direct drive planetary gear system. This cutting-edge technology eliminates belts and pulleys, reducing maintenance and enhancing performance. Our advanced hybrid motors and planetary gears work together to provide faster, more precise motion, ensuring exceptional speed and accuracy while remaining virtually maintenance-free.

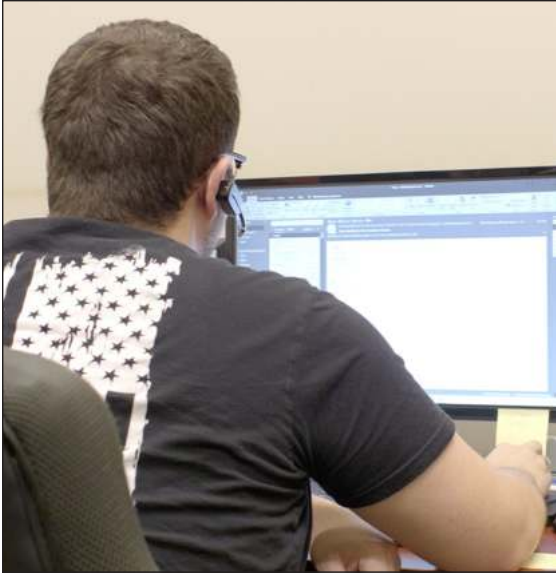

SHOPSABRE LIFETIME TECHNICAL SUPPORT

Every new ShopSabre CNC machine comes with lifetime technical support, and we encourage you to use it when you need it. We stand by our machines, and we stand by our support. In many cases, our customer support team can resolve your issue remotely via phone, email, or Internet connectivity. If your issue requires on-site support, we have the ability to send someone over as quickly as possible. Please note that on-site support may incur additional charges, but we will always do our best to minimize any expenses to you.



TRAINING FOR LIFE

ShopSabre proudly provides lifetime training to ensure optimal machine performance. Our SabreNation University offers video tutorials from our team, including RouterBob, with tips, tricks, and software guidance. New videos are uploaded monthly for ongoing training. We also offer free remote assistance and training via Internet and phone, allowing you to start quickly without scheduling trips or waiting for technicians. Additionally, we provide free access to our monthly one-day Machine Operator Basic Training Course at our Lakeville, Minnesota facility for hands-on learning.



AMERICAN MADE

Here at ShopSabre CNC, we take great pride in the fact that all of our machines are truly built and supported in the United States of America. Unfortunately, some customers don't understand the value of American built until it is too late. Many times others are simply fooled into thinking that Chinese imports are a better investment because they can cost less up front.

Proudly Manufactured, Assembled, and Supported in the USA!

ShopSabre CNC
21673 Cedar Ave.
Lakeville, Minnesota, 55044, USA





Colton, Mike
Badger ISD #676
110 Carpenter Avenue
Badger, MN, 56714
218-686-1258
Mcoltom@badger.k12.mn.us





QUOTE NO. 022490-R0
DATE: 15 July 2025
EXPIRATION DATE: 30 day(s) from Quoted Date Unless Stated Otherwise
Warranty Information:

ShopSabre CNC Systems come with 1 year parts warranty. Also included with all New machine purchase is SabreNation Access which includes Life-Time Technical Assistance available by Telephone, Email, and On-Line Support. See Warranty Sheet for Details. Regarding Router Systems – No Warranty is implied for cut performance on Non-Ferrous Material such as but not limited to Aluminum, Brass, etc. Warranty is Void for cutting of any ferrous metal on CNC Router System.

SALESPERSON	P.O. #	PAYMENT TERMS	Financing Available
Chad Wilson		First 50% at Time of Order; Remaining 50% Prior to Shipping	Shopsabre.com/financing
FOB: Origin		Accepted Payment: Wire Transfer, Check, or Credit Card – Credit Card Subject to 3.5% fee	

CNC PLASMA MACHINES





Product Description	QTY	Line Total
<p>9200-1011 SK4 Plasma System</p>  <ul style="list-style-type: none"> • ShopSabre SideKick 4 Plasma System • Welded Steel Frame, Tube Steel Gantry, Steel Machine Base • Emergency Stop Switch • Limit Switches on X,Y,Z Axis with Auto Squaring and Boundary Alarms • Enclosed Wire Carriers for Wire Protection • Industrial Precision Rack and Pinion Drive System on X & Y Axis • Planetary Gear Drives XY Axis with Heavy Duty Closed-Loop Motors with Encoder Technology on XYZ Axis. • Industrial 25MM Precision Linear Guide Rails & Bearings • Inner Table Slats & Brackets • Plasma Cutter On/Off & Arc Confirmation Ports for Electronic Control • SideKick Breakaway Z Torch Mount with Level for Torch Alignment • Advanced Digital Torch Height Control with Auto Touch System (THC) and Touch Distance Control Technology • WINCNC Industrial Controller Hardware & Software • ShopSabre Computer System - Full Size Desktop System, Windows OS with Solid State Hard Drive, 16GB Memory, 19" Flat Screen Monitor, Keyboard, Mouse • Hypertherm ProNest LT CAD/CAM Plasma Software - 12 Months • EnRoute Fabrication CAD/CAM Software - 12 Months <p>ShopSabre SabreNation Support Included– Life-Time Technical Support via Phone, Email, and Remote Connectivity (Internet connection required)</p> <p>ShopSabre SabreNation Training Included – Access to ShopSabre digital SabreNation University training & videos, lifetime access for 2 People to attend ShopSabre Basic Training Course at ShopSabre CNC Facility in Lakeville Minnesota 55044 (Some limitations may exist, please call for details).</p>	1	
<p>8200-1046/8200-1045 Electronic Torch Collision Detection with Emergency Stop</p>  <p>ShopSabre high performance electronic Torch Collision Detection with auto alignment and emergency stop feature. This feature allows the machine torch to sense material contact and abort the machine without hesitation to avoid damage to the machine or material. This feature is so advanced that it will allow the torch to stay connected at all times without risk of damaging your machine torch from breakaway and due to the unique auto alignment feature it will allow the torch to remain in proper alignment even after a collision has taken place. This comes with adjustable sensitivity and a proxy sensors to assure you get maximum performance from your plasma machine.</p>	1	Option Included
<p>8200-1003 Laser Sights</p>  <p>Quick XY Zero Laser Sights gives you a quick reference point for where the torch tip will be located. This system has a built in offset and is pre-programmed with a "LASER ZERO" button for quick and effortless material setup.</p>	1	Option Included
<p>8300-1081 Hypertherm PowerMax 45 SYNC with 25 Lead</p>  <p>Hypertherm PowerMax 45 SYNC with 25 Lead (Add \$100 for 50ft. Torch) Versatile, professional-grade plasma cutter offers increased cut capacity as well as enhanced gouging and marking capabilities. Best performance on 1/4" and down (Mild Steel)</p>	1	Option Included







	<p>8200-1051 Add Sidekick Water Table for 4 x4 with 5 Gallons of Plasma Defense Add Sidekick Series 4" Water Table for 4 x 4 machine. This feature comes fully welded & leak tested and includes 5 Gallons of ShopSabre Plasma Defense water treatment. All ShopSabre Water Tables will include a drain with drain cover, Water Table Isolation Diode, Lateral Bracing for Structural Engineering Reinforcement, and Welded Slate Brackets. ShopSabre Water Tables are integrated into frame design for a one peice structure prior to Shipping.</p>	1	Option Included
	<p>5300-2002 SheetCam TNG Software License Milling, Routing and Plasma CAM software for Windows and Linux.</p>	1	Option Included
	<p>8400-1014 Maintenance Kit Maintenance Kit Includes ShopSabre recommended Grease (3 Tubes), required needle fitting, and a professional grease gun.</p>	1	Option Included
<p>ShopSabre CNC - SideKick 4 Instant Saving - Expires at the End of this Month</p>		1	-2,484.00
	<p>ShopSabre CNC – Lower 48 States Shipping Incentive – Max Value \$2000.00 Expires 07/31/2025 ShopSabre CNC – Shipping Credit Offer Maximum Value: \$2,000.00 Expires: End of Month This credit applies to standard shipping within the lower 48 states only. It does not apply to drop ship items such as but not limited to edge banders, air compressors, sanders, or dust collectors. This credit excludes rush deliveries, special delivery requirements, and any non-standard shipping expenses or adjustments.</p>	1	0.00

CNC Plasma Machine Subtotal: \$22,081.00

Additional Machine Options Below are NOT included in the quoted price. Some Options May Require Install at Manufacturing Time.



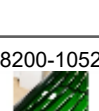





SIDEKICK PLASMA TABLE OPTIONS

Product Description		Add/Remove
	<p>8200-1005 Oxy-Fuel Attachment - Connects to Existing Tanks/Gauges ShopSabre Oxy-Fuel Attachment Torch allows you to use your CNC Plasma machine for higher cutting demands that require the use of a Oxygen Fuel combination torch. This device includes the Torch, Mount, and hoses which you will then connects to your existing Tanks/Gauges. Note, this is a manual light operation with automated oxygen blast.</p>	2,550.00
	<p>8200-1002 ShopSabre Drill Unit Model 252-40TPK30 ShopSabre Drill Unit Model 252-40TPK30 gives you the ability to use your CNC Plasma machine as a CNC Drill. This feature comes with a 3/8" capacity and allows you to drill holes where tolerances exceed that of a CNC Plasma flame. These 3/4HP drills are industrial solutions to your CNC Fabrication needs. * Not Available with Router Options * ShopSabre does Recommend SheetCAM or ProNest Software for Drill Programming</p>	5,500.00
	<p>8200-0096 Water Table Removable Splash Guards for SideKick 4 & 8 Sizes Industrial designed Steel Water Table Removable Splash Guards for SideKick 4 & 8 Sizes - Painted Yellow for visibility and designed to be removed when loading machine and reinstalled in seconds to minimize the debris and splash associated with maximum capacity plasma cutting.</p>	300.00
	<p>8200-1007 Vibrating Plate Marker for Etching Steel Surface ShopSabre Vibrating Plate Marker for Etching Steel Surface, this accessory is great for pattern marking, hole layouts, part number scribing, marking fold or weld lines, or simply adding some artist design to your products.</p>	1,695.00
	<p>8200-1006 Deluxe Marker Pen Attachment (Plasma) ShopSabre Deluxe Marker Pen Attachment includes ability to utilize a Full Size Marker, Compact Marker, Pencil, Ball Point Pen, or Fine Tip Marker. This device fits into a collet and will allow your machine to draw complex shapes, trace, mark, or even label.</p>	355.00



<p>8200-0099</p> 	<p>Sheet Alignment Brackets (Removable Brackets) ShopSabre Plasma Steel Sheet Alignment Brackets allow for quick and effortless sheet loading and alignment on your CNC Plasma machine. These 3 brackets can be removed easily and placed conveniently where you determine necessary for the variety of sheet sizes you may be working with.</p>	<p>400.00</p>
<p>8200-1047</p> 	<p>Digitizing Touch Probe Digitizing Touch Probe for 2D & 3D Tracing. This device allows you to turn your CNC system into an Automated digitizing solution for reverse engineering or copying of components or parts. This package will include a 10mm collet a required for all CNC router applications.</p>	<p>605.00</p>
<p>8200-2004</p> 	<p>ShopSabre Manual Bevel Torch Mount The ShopSabre manual bevel torch mount works with both collision detection & breakaway torch mounts. The manual bevel torch mount is manually adjusted left or right to allow you to tip the torch to create bevel cutting that fits your needs. For making bevel cut along Y-axis only, will lose small amount of total Y-axis travel (1"-1.5"). Bevel mount not compatible with additional Z-axis options such as: vibrating plate marker, marker pen kit, oxy-fuel torch, drill head. Note: Bevel cut quality will vary based on cutter power level and material thickness. The torch mount allows operation outside the standard cutting envelope — use extreme caution when operating near the edges of the machine to avoid potential damage. It is the user's responsibility to understand and properly manage the bevel cutting angle. Improper setup or exceeding recommended parameters may result in machine damage. Any damage resulting from bevel cutting is not covered under the ShopSabre warranty.</p>	<p>395.00</p>
<p>9200-1012</p> 	<p>Add Bubbler System for Aluminum Cutting (Requires 6 Water Table) The ShopSabre Bubbler option is a great solution for those who need to cut aluminum with their plasma machine but want the benefits of a water table design. Historically, water tables and aluminum haven't gotten along but with the bubbler this gives you the ability to connect compressed air to your table to circulate the water and reduce the risks of gas bubbles getting trapped in the water creating unsafe work environments that are associated with aluminum plasma cutting.</p>	<p>2,050.00</p>
<p>8200-1052</p> 	<p>Add Sidekick 6 Extended Water Table for 4 x4 with 5 Gallons of Plasma Defense Add Sidekick Series 6" Extended Water Table for 4 x 4 machine. This feature comes fully welded & leak tested and includes 5 Gallons of ShopSabre Plasma Defense water treatment. All ShopSabre Water Tables will include a drain with drain cover, Water Table Isolation Diode, Lateral Bracing for Structural Engineering Reinforcement, and Welded Slate Brackets. ShopSabre Water Tables are integrated into frame design for a one piece structure prior to Shipping.</p>	<p>1,175.00</p>
<p>5500-1085</p> 	<p>Langmuir Systems ArcFlat 24" x 36" Modular Cast Iron Weld Fixture Table featuring 5 Perpendicular Machined flat surfaces and 336 fixture holes. Machined flat to +/- .0075" and square to .1 degrees</p>	<p>825.00</p>
	<p>ArcFlat Drop Shipping</p>	<p>150.00</p>

Package includes Leg Kit (4 Steel Tube Legs and Leveling Feet) + Precision Leveling Bolts for joining 2 blocks together + Modular Fixture Clamp for use with vertical & horizontal clamping.







SIDEKICK PLASMA COMBO ROUTER TABLE OPTIONS

Product Description		Add/Remove
8200-1013	 <p>SideKick Router Package SideKick Series CNC Router Package for converting your CNC Plasma into a combination CNC Plasma/CNC router machine. This package includes a 3.5HP 110V. router with ShopSabre engineered machine Mounting Bracket, Industrial Continuous flex Power Cord, and full CNC G-Code Control of On/Off. These Systems give you the versatility of having a multiple functions from one machine. ** Note - No Routing Table Top is provided, customer responsible for table top that fits needs</p>	1,200.00
8200-1041	 <p>3KW 4HP HSD 18,000 MAX RPM Spindle with VFD - Manual Change Italian Built Industrial Electric Fan Cooled Manual ER25 Collet Style Spindle Package - 3KW 4HP HSD 18,000 MAX RPM Spindle includes S1 Rated VFD Spindle Package Includes: 3 Qty - ER25 Collets (1/4", 3/8", and 1/2"), Set of Standard Collet Wrenches, and Mitsubishi VFD for S1 Rated 1Phase or 3 Phase Spindle Operation (200-240V.) - Subtract \$600.00 for 2.2HP Version **Note – No Routing Table Top is provided, customer responsible for table top that fits needs.</p>	3,550.00
8200-1042	 <p>Automated Software Control for Spindle On/Off Automated Software Control for Spindle On/Off allows the spindles On/Off to be controlled both manually or automated through G-Code.</p>	355.00
8200-1043	 <p>Automated Software Control for Spindle RPM Automated Software Control for Spindle RPM Control allows the spindles RPM to be controlled both manually or automated through G-Code.</p>	460.00
8300-1056	 <p>Tool Measure Switch - Measures Tooling Height without Changing Z Height ShopSabre exclusive Tool Measure Switch gives you added versatility with increased accuracy. The Tool Measure technology by ShopSabre isolates your tool length from your Z Zero allowing you more accuracy and control for quicker tool changes and more accurate cutting processes. This device specifically measures the Tooling Height without Changing Z zero height.</p>	355.00
8200-1048	 <p>Material Height Touch Pad - Electronic Z Setter Material Height Touch Pad allows independent Z Axis Zero by using a integrated double touch for a calculated Z Zero independent from your tool length calibration. This device makes setting Z Zero easy, quick, and reliable.</p>	401.00
8100-2012/8100-2013/8100-2014/8100-0084	 <p>Quick Release Dust Skirt- 4 Outlet for Connecting to Dust Collector ShopSabre Standard Quick Release Dust Skirt with 4" Outlet for Connecting to Dust Collector - Does not include dust hose - ShopSabre recommends grounding all dust collector connections for static discharge.</p>	350.00
5300-1022	 <p>Vectric Vcarve Pro True Router Software Vectric Vcarve Pro True Router Software (Latest Addition) VCarve Pro provides a powerful but intuitive software solution for creating and cutting parts on a CNC Router. VCarve Pro gives you the power to produce complex 2D patterns with profile, pocket, drill and inlay toolpaths, plus gives you the ability to create designs with v-carving textures as well as import and machine unlimited Vectric 3D clipart or single model files. The 'Pro' edition gives you unlimited job and toolpath size, true shape nesting & job set-up sheets, ideally suited to a production environment.</p>	700.00

PLASMA CUTTING POWER UNIT OPTIONS

Product Description		Add/Remove
8300-1068	 Hypertherm PowerMax 65 SYNC with 25 Lead Hypertherm PowerMax 65 SYNC with 25 Lead Powermax SYNC™ series, the next generation of Powermax65@/85/105 systems, is unlike any plasma you've seen before. Featuring built-in intelligence and a revolutionary single-piece cartridge consumable, Powermax SYNC simplifies system operation, streamlines consumable inventory, lowers operating costs, and maximizes performance. Best performance on 3/8" and down (Mild Steel)	1,025.00
8300-1065	 Hypertherm PowerMax 85 SYNC with 25 Lead Hypertherm PowerMax 85 SYNC with 25 Lead Powermax SYNC™ series, the next generation of Powermax65@/85/105 systems, is unlike any plasma you've seen before. Featuring built-in intelligence and a revolutionary single-piece cartridge consumable, Powermax SYNC simplifies system operation, streamlines consumable inventory, lowers operating costs, and maximizes performance. Best performance on 1/2" and down (Mild Steel)	2,325.00





COMPUTER SYSTEMS AND ACCESSORIES OPTIONS

Product Description		Add/Remove
8300-1013	 USB Wireless for Computer Internet/Network Connectivity USB Wireless dongle for Computer Internet/Network Connectivity - This feature gives you the freedom to file transfer, network, or remote diagnose without the need to connect an ethernet cable. Note: High Speed Internet connection required for use of internet features.	100.00
8300-1057	 Upgrade to 24 Touch Screen Monitor with PCAP Technology Upgrade to 24 inch Touch Screen Monitor with PCAP Technology to assure easy and clean functionality of your ShopSable Controller.	1,220.00
8100-1012	 ShopSable Wireless Hand-Held Controller Pendant with Jog Wheel ShopSable Wireless Hand-Held Controller Pendant with Jog Wheel gives you the freedom of a remote with the professionalism of your CNC control. These Controller pendants have built in magnets so you can stick them to your machine or control stand without losing them. These controllers communicate directly to the provided dongle so you don't have to worry about interference with other controllers in your shop and they come with custom programmable buttons to give you all the function you need for your machine!	450.00
8100-0089	 ShopSable Rolling Control Stand ShopSable Steel Rolling Control Stand (Not Enclosed) allows for an easy computer management system. This Industrial built rolling cart gives your operator a clean and convenient place to control your CNC machine from.	605.00
8300-1055	 Machine Mounted Monitor, Keyboard, & Computer Stand ShopSable Machine Mounted Monitor, Keyboard, & Computer Stand gives you a clean and professional controller management system. This adjustable stand frees up floor space while making it convenient for your operator to control the machine.	360.00
8100-1241	 Warning Light Bar This light tower lets you know when the machine is running or not running for quick reference and safety of your operator. This Tower illuminates Red or Green based on the machines actions and cycles automatically so your team can keep an eye on the work flow.	765.00



AUTOMATION SPECIFIC OPTIONS

Product Description		Add/Remove
8300-1088	UL/CUL Certified Control Box for RC/SK/SS23 UL/CUL Certified Control Box	4,000.00
		

AIR COMPRESSOR AND DRYER OPTIONS

Product Description		Add/Remove
5500-1030	3-STAGE 20CFM FILTER PACK Includes a water separator , coalescing .01micron filter, oil vapor activated carbon filter and regulator all rated for 20 cfm max	960.00
		
5500-1023	5HP 60 Gal Compressor, Fully Packaged with Air Dryer - Single Phase Fully Packaged with after cooler, auto tank drain & installation kit. 175psi:15CFM DRYER 25ACFM 1/2 NPT 115/1/160 DRYER, 25ACFM, 1/2" NPT,115/1/160 VOLT, 230 MAX PSI	4,928.96
		
5500-1025	5HP COMPRESSOR, 80 GAL. TANK - Single Phase 2 Stage: 15 CFM PSI:145-175 with DRYER 25ACFM 3/4 NPT 115/1/160 DRYER 25ACFM 1/2 NPT 115/1/160 DRYER, 25ACFM, 1/2" NPT, 115/1/160 VOLT, 230 MAX PSI	6,304.70
		
5500-1026	7.5HP, FULLY PKGD 80 Gallon Tank - Single Phase Fully Packaged with after cooler, auto tank drain & installation kit. 175psi: 24CFM DRYER 40ACFM 1/2 NPT 115/1/160 DRYER, 40ACFM, 1/2" NPT,115/1/160 VOLT, 230 MAX PSI	7,578.80
		

PIPE CUTTING OPTIONS

Product Description		Add/Remove
8200-1000	4th Axis Pipe Cutter with Chuck Head- 5 on table - No Software included ShopSabre 4th Axis Pipe Cutter Attachment with Steel Industrial Chuck Head and Rollers for Use with Pipe Cutting up to Maximum of 5" Diameter. This System is designed to be installed when you need it and removed when you are not using it to save you valuable floor space and reduce the bulk of a seperate system. No Software is included with this Package but it is compatible with EnRoute Fabrication or Hypertherm Rotary Tube Pro - See Available Software options for Pricing on Pipe Specific software.	2,550.00
		
8200-1008	Sidecar 4th Axis Pipe Cutter with Chuck Head - 10 off table ShopSabre 4th Axis Sidecar Pipe Cutter Attachment with Steel Industrial Chuck Head and Rollers for Use with Pipe Cutting up to Maximum of 10" Diameter. This System is designed to be there when you need it as it is attached to the right side of your machine with zero setup required. No Software is included with this Package but it is compatible with EnRoute Fabrication or Hypertherm Rotary Tube Pro - See Available Software options for Pricing on Pipe Specific software.	6,595.00
		
8100-0095	4th Axis Port for Future Installation of 4th Axis System Pre-Wiring for future installation of 4th Axis Option - This option assures your ShopSabre comes ready for future plug and play operation of the 4th Axis electronic system.	500.00
		

TC SERIES OPTIONS

	Product Description	Add/Remove
9200-1018	 Tube Cutter 12 <ul style="list-style-type: none"> • ShopSabre Tube Cutter 12 Foot CNC Plasma System • Welded Structural Tube Steel Frame & Steel Machine Base • Emergency Stop Switch • Limit Switches on X,Y,Z Axis with Auto Squaring and Boundary Alarms • Enclosed Wire Carriers for Wire Protection • Heavy Duty Closed-Loop Motors with Encoder Technology on XYZ Axis. • Plasma Cutter On/Off & Arc Confirmation Ports for Electronic Control • TC Series Torch Collision Detection system with Auto Torch Alignment • Advanced Digital Torch Height Control with Auto Touch System (THC) and Touch Distance Control Technology • ShopSabre Industrial Controller Hardware & Software with at machine Windows OS • ShopSabre Computer System - Full Size Desktop System, Windows OS with Solid State Hard Drive, 16GB Memory, 19" Flat Screen Monitor, Keyboard, Mouse • Hypertherm Rotary Tube Pro Software • ShopSabre SabreNation Support Included– Life-Time Technical Support via Phone, Email, and Remote Connectivity (Internet connection required) • XY Quick Zero Laser Sights 	34,995.00
9200-1019	Tube Cutter 24 <ul style="list-style-type: none"> • ShopSabre Tube Cutter 24 Foot CNC Plasma System • Welded Structural Tube Steel Frame & Steel Machine Base • Emergency Stop Switch • Limit Switches on X,Y,Z Axis with Auto Squaring and Boundary Alarms • Enclosed Wire Carriers for Wire Protection • Heavy Duty Closed-Loop Motors with Encoder Technology on XYZ Axis. • Plasma Cutter On/Off & Arc Confirmation Ports for Electronic Control • TC Series Torch Collision Detection system with Auto Torch Alignment • Advanced Digital Torch Height Control with Auto Touch System (THC) and Touch Distance Control Technology • ShopSabre Industrial Controller Hardware & Software with at machine Windows OS • ShopSabre Computer System - Full Size Desktop System, Windows OS with Solid State Hard Drive, 16GB Memory, 19" Flat Screen Monitor, Keyboard, Mouse • Hypertherm Rotary Tube Pro Software • ShopSabre SabreNation Support Included– Life-Time Technical Support via Phone, Email, and Remote Connectivity (Internet connection required) • XY Quick Zero Laser Sights 	39,995.00

EXTENDED WARRANTY OPTIONS

	Product Description	Add/Remove
9900-1004	SabreShield by ShopSabre 1 Year Extended Warranty ShopSabre Platinum Plan – Extends machine warranty 1 additional year with a \$350.00 deductible on all claims. All claims after 1 year factory warranty are subject to underwriting and extended warranty excludes coverage for damaged items, electrocution, collision, moisture, abuse, or lack of maintenance. Coverage does not cover labor unless otherwise determined necessary by ShopSabre Technical Support. Travel expenses not included with labor coverage. Customer will be responsible for freight costs.	3,500.00

This is a quotation on the goods named, subject to the conditions noted below - ShopSABRE Terms are Only Terms:

Please Allow 4 to 18 Weeks for Delivery, This is not a guarantee on deliver time just an estimate based on averages as delivery may be delayed due to but not limited weather, parts availability, supply chain constraints, and/or shop production levels. ShopSABRE recommends having electrician present for power installation - ShopSABRE does not recommend accepting jobs for machine until installed as delays can happen. Client is responsible for all shipping and related costs, fees, etc. Consignee will need to have the necessary equipment to unload machine and accessories from delivery truck(s), ShopSABRE does recommend a loading dock where possible for unloading of equipment, it will be the customers responsibility to communicate any special needs and requirements and any additional charges based on needs will be client's responsibility. Additionally, ShopSABRE recommends 7500lb Forklift or larger with a minimum of 6-8-foot-long forks for offloading equipment. Note: drop ship items will ship separately from machine order – Ask for Details. In the event a truck cannot be offloaded or is delayed in offloading any additional costs that occurs will be chargeable to receiver and must be paid prior to support or training. ShopSABRE is not responsible or liable for unloading/shipping coordination or expenses. This quote does **NOT** include any State/Local taxes, import duties/fees etc unless specifically listed and will be collected prior to shipping unless tax exemption can be provided. This machine is quoted to be received fully assembled. - CNC MACHINES CAN BE DANGEROUS - BUYER ACCEPTS LIABILITY AND RESPONSIBILITY FOR INSTALLATION OF SAFETY ITEMS SUCH AS BUT NOT LIMITED TO LIGHT CURTIANS, BARRIERS, and SAFETY MATS. - On Plasma Machines client MUST Provide Plasma Cutter for testing if not purchased from ShopSABRE CNC at time of order - All Sales Are Final and Any Cancellations for ANY reason results in 35% Cancellation/Restocking Fee. To accept this quotation, ShopSABRE Terms & Conditions + Warranty please sign here and return:

Subtotal:	\$22,081.00
Crating & Materials:	450.00
Estimated Shipping:	0.00
Total:	\$22,531.00
Required Deposit	11,265.50
Balance Prior to Shipping	11,265.50
Finance for As Low As	\$405.56 /72

***Quote Notes:**

Chad Wilson



FAST. EASY. FINANCING

THE ADVANTAGES OF WORKING WITH SHOPSABRE

TAX DEDUCTIONS - Depending on your specific purchase, there may be some beneficial ways to save on your yearly taxes.

CASH FLOW - Financing or leasing a piece of equipment allows you to keep your cash flow for other purchases.

DEFERRED PAYMENTS - You may qualify for a deferred payment allowing you to get into equipment before your first payment is due.

100% FUNDING - Many times our lenders have solutions that include no money down financing with competitive bank rates.

START UP BUSINESSES - Lenders are often willing to work with those who may not already have an established company. ShopSabre CNC offers many commercial financing and leasing options through our trusted third-party lenders. We use lenders who understand the benefits of ShopSabre CNC

equipment, allowing you to receive better rates and terms than other companies and eliminating using personal credit as collateral. ShopSabre CNC is proud to offer these options to our clients so you can get the equipment that's right for you.

We work together to make a seamless and easy transaction allowing you to get into that new piece of equipment quickly.

Many times we can get you approved in as little as 2 hours! We are glad to work with your own lender too!



Connor Winkelman | Sales Manager
connor@gogc.com
320-759-3515

SideKick Series

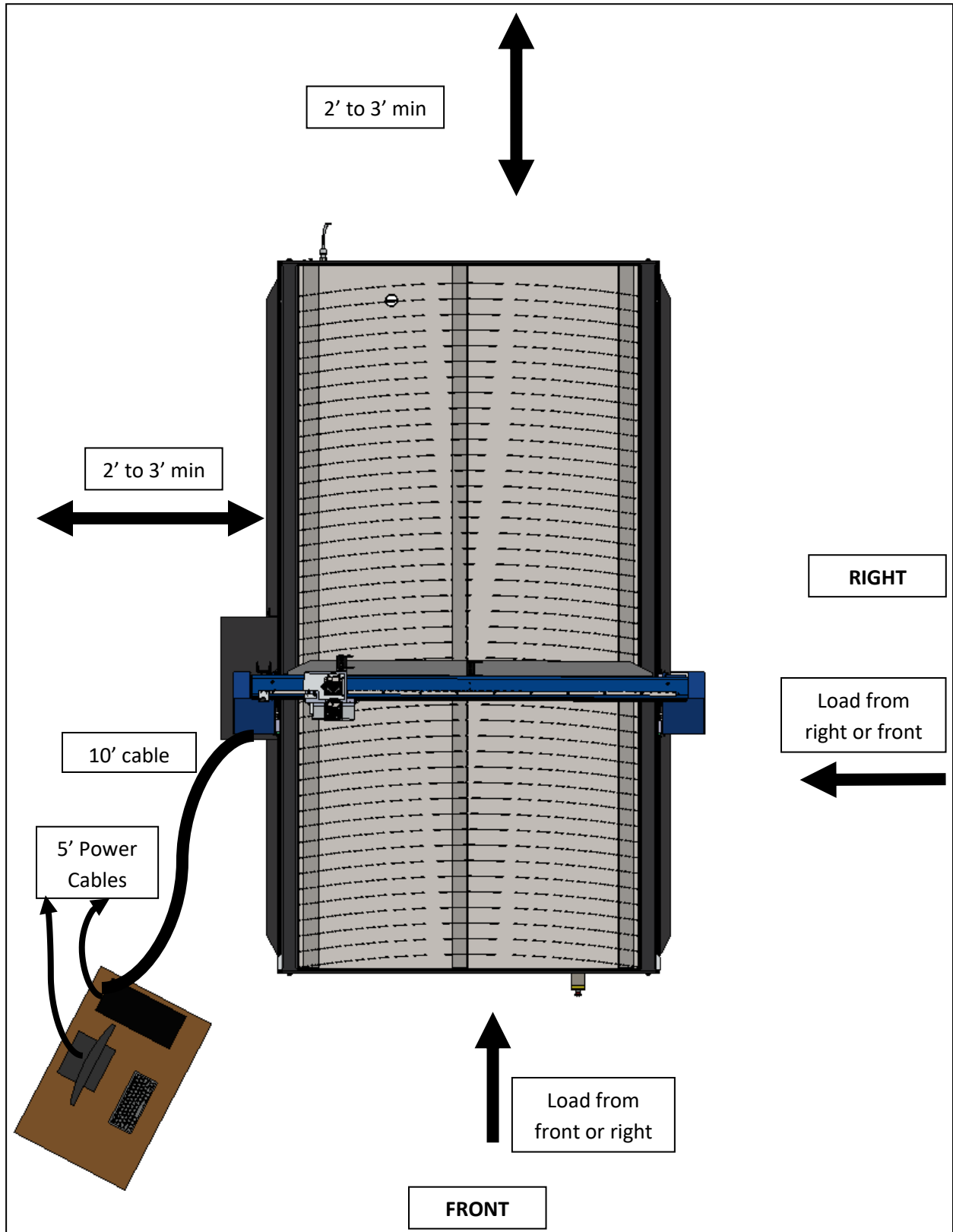

SideKick 4 with Sidecar

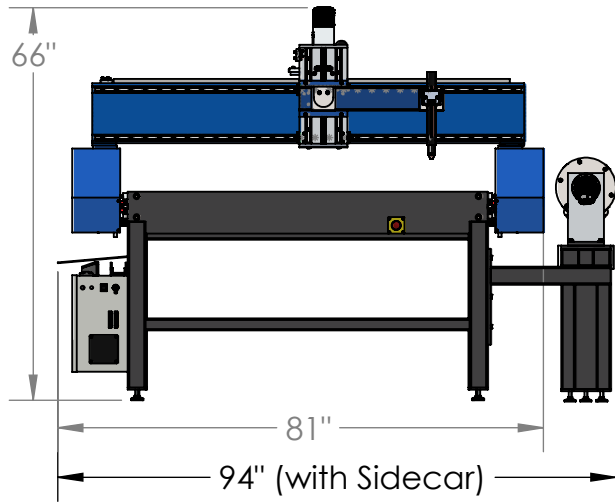

Front

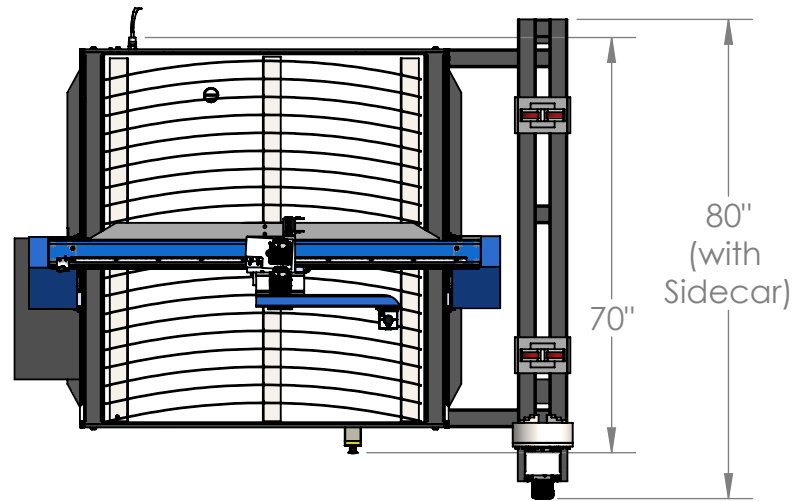

Top

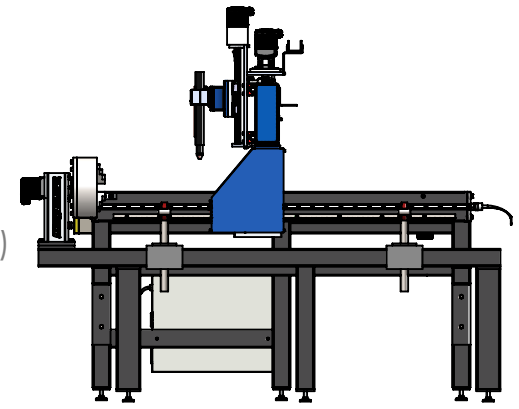

Right

Shop SABRE

SideKick 4

MODEL SPECS

- Table Bed Cut Area: W 52" x L 49"
- Gantry Clearance: 8" standard
- Z Travel: 9"
- Maximum Travel Speeds on X & Y: 1500IPM standard
- Machine Weight: 1400 - 1900 lbs
- Machine Foot Print (Including Gantry): 81" x 70"x 67"
- Machine Structure: Welded over-sized steel tube frame
- Gantry Structure: Large tube steel with tube steel gantry uprights
- Drive System: Single X dual Y axis rack and pinion driven with floating drive technology - Z axis ball screw
- XYZ Bearing System: 25mm linear guide rails and bearings with quad roller sets and triple seal by THK/HiWin
- Controller: ShopSabre WINCNC Advanced Controller
- PC System: Included with SSD hard drive and PCI controller board installed
- Networkable: Yes
- PC to PC Connectivity for Diagnosis and Training: Yes
- Software: 12 month license of CAD/CAM software included
- Controller Software Updates: Included
- Manufacturer: United States – ShopSabre Facility – Minnesota
- Fully Assembled
- Pre-Tested
- Lifetime Tech Support (Phone/Email/PC2PC)